

# DR70 S E R I E S

**HIGH-FLOW and HIGH PRESSURE Regulator**

**Drop-prevention function Built-in**



## FUNCTIONAL SCHEMATIC

### ■ BOLT CONTROL TYPE (DR701 SERIES)

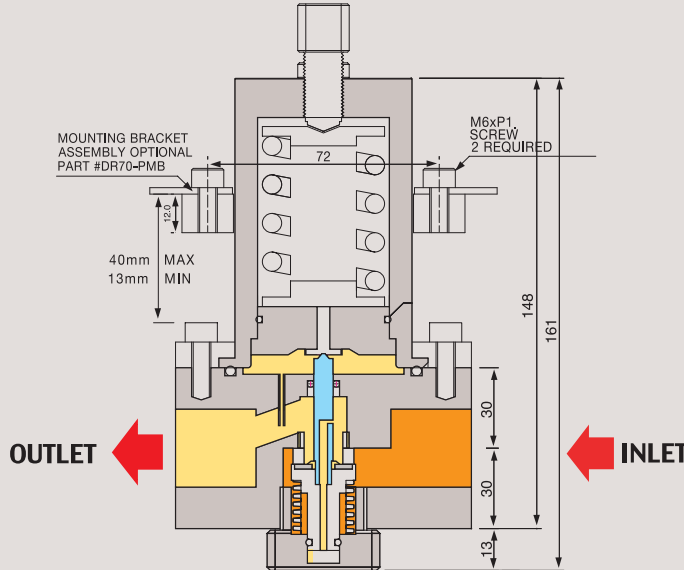

## INSTALLATION DIMENSIONS

### ■ BOLT CONTROL

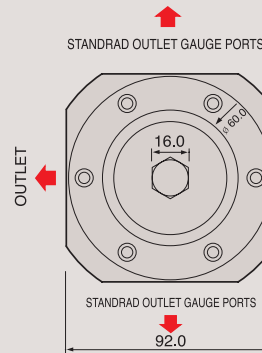

### ■ KNOB CONTROL TYPE

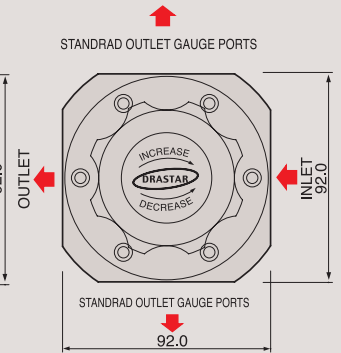

### ■ MOUNTING BRACKETED

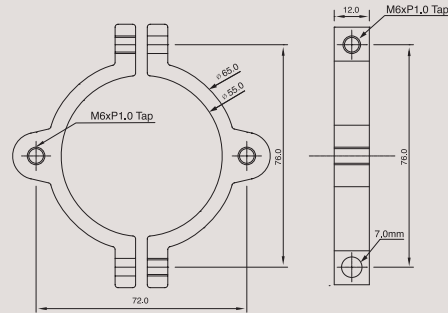

## HIGH-FLOW AND HIGH PRESSURE

### DR70 SERIES

DR70 시리즈는 물, 케미칼, Liquid 또는 가스등 많은 유량을 필요로 하는 배관라인등에 가장 적합한 제품이며 배관 사이즈는 NPT or BSP 3/4, 1" 까지 선택하여 사용 가능하며 제품의 장점은 자체적으로 DROP를 완전히 보정해주기(잡아주기) 때문에 P1의 압력 변화가 크더라도 P2의 압력(조정 또는 셋팅압력)은 변화없이 안정적으로 정밀하게 유지시켜 주는 레귤레이터 입니다. Body 의 재질은 모델에 따라 Brass and Stainless steel 316L로 이루어졌으며 입구 압력은 Brass 250bar(3625psi) Stainless steel 350bar(5076psi)까지 폭넓게 사용 가능하며 각각의 모델에 따라 Outlet Working pressure 0.5~55bar(780psi)까지 사용할 수 있습니다.

**DR70 Series** is a regulator most suitable for pipeline application where high flow of water, chemical, liquid, gas, etc. is requested. NPT or BSP 3/4" and up to 1" pipe can be selectively used to this series. The self-correction function of DROP built in this regulator enables to keep the P2 pressure (adjusted or setting pressure) stable and constant without impact from P1 if it faces big pressure differences at P1. Regulator body is made of brass or stainless steel 316L and has the wide range of inlet pressure up to 250bar (3,625psi) for brass body and 350bar (5,076psi) for stainless steel body respectively by model. Outlet working pressure has the range of 0.5~55bar(780psi) by model.

#### Features

- Precision control of NPT or BSP 3/4" 1" Type Regulators
- Drop-prevention function Built-in.
- Suitable for the research labs, industrial control
- Outlet 10bar(145psig), 25bar(362psig), 50bar(725psig), 70bar(1015psig)
- Panel mounting Bracket #DR70-PMB option
- Outlet 150bar(2100psig), 250bar(3600psig), 350bar(5000psig): SH Model

#### 관장 사항

각 제품들은 최고의 안전성과 쉬운 조작성을 고려하여 제작되었습니다. 그러나 가장 안전하고 효율적인 Regulator 사용을 위해서는 실제 사용 압력을 각각의 모델에 따라 25%~75% 이내에서 사용하면 가장 이상적인 압력을 사용할 수 있습니다, 정밀하고 원활한 동작과 제품의 수명 연장을 위해서는 위의 범위 내에서 사용하기를 적극 권장합니다.

**REFERENCE**

This catalogue is printed as of January 2016, and the dimensions and/or specifications in this catalogue can be changed without prior notice in the course of constant upgrading and improvement of our products.

**FUNCTIONAL SCHEMATIC**

■ **KNOB CONTROL TYPE (DR702 SERIES)**

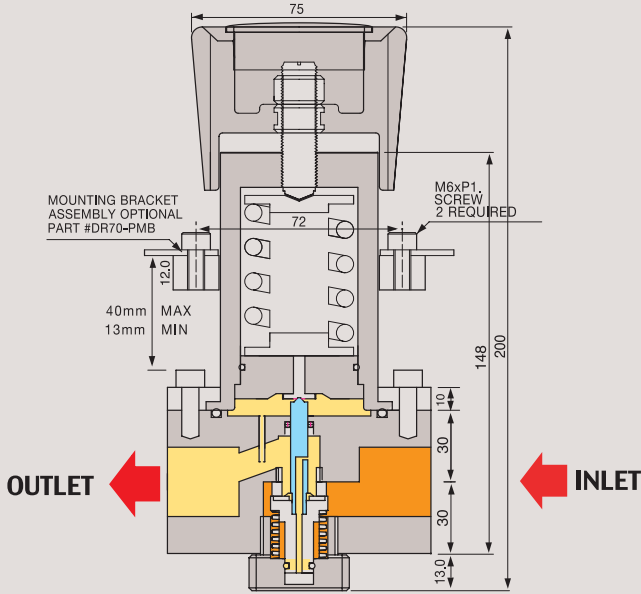

**INSTALLATION DIMENSIONS**

(For SH Type - 12pcs Bolts)

■ **BOLT CONTROL**    ■ **KNOB CONTROL TYPE**

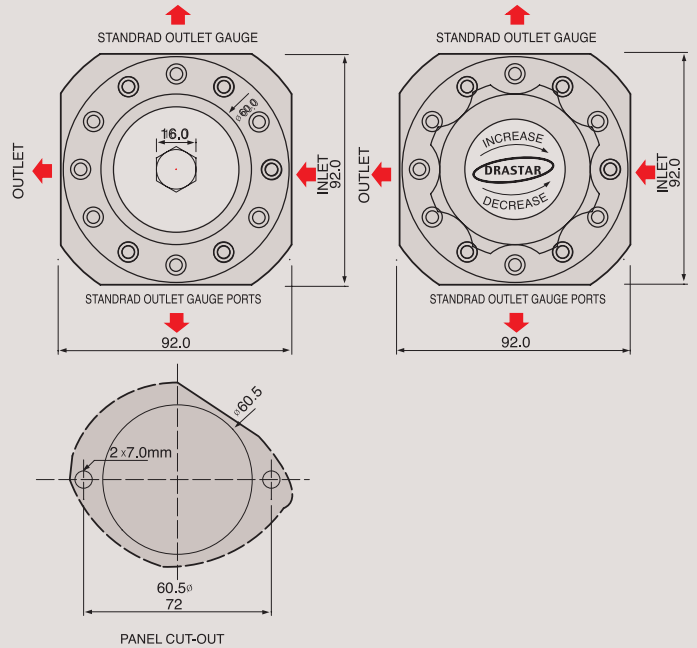

**Recommendations**

Each product is manufactured since being taken into consideration of the best safety and easy manipulation. However in order to use the regulator in most safe and effective way, you are recommended to use the actual pressure within the range of its 25% ~ 75%. For making precise, smooth movement and to prolong product life, strongly recommended to make a use within above mentioned range.

**주의**

크린라인이 아닌 일반 라인에 사용 할 경우 필터링(gas 7 $\mu$ m~15 $\mu$ m, water 15 $\mu$ m~80 $\mu$ m)은 필수이며, 그렇지 않으면 바로 고장의 원인이됩니다. 모든 제품의 필터링하여 사용하면 A/S 비용 절감과 함께 제품의 수명연장에 많은 도움이됩니다

**Caution**

Filtering (Gas 7 $\mu$ m~15 $\mu$ m, water 15 $\mu$ m~80 $\mu$ m) is a Must for General gas application such as Non-high purity gas. Otherwise, it may cause a breakdown to the regulator. It is strongly recommended to install filter for prolong product life time and enable saving maintenance expense.

**ORDERING INFORMATION**

**DR702 - S P - 010 - NP 2 - V - H1**

BASIS SERIES NUMBER	BODY MATERIAL	VALVE SEAT	CONTROLLED PRESSURE RANGE	INLET OUTLET PORTS	INLET OUTLET PORTS SIZE	SELF VENTING	HIGH TEMPERATURE
DR701 = Bolt Control	S = STS 316L 200bar (3000psi)	P = Teflon V = Vespel	010 = 10bar (145psi) 025 = 25bar (362psi) 050 = 50bar (725psi) 070 = 70bar (1000psi)	NP = NPT BS = BSP	2 = 3/4" 3 = 1"	V = Self-Venting	H1 = 120° C H2 = 250° C H3 = 500° C
DR702 = Knob Control	B = BRASS 150bar (1500psi)  SH = STS 316L 420bar (6000psi)		SH Model Only 150 = 150bar (2100psi) 250 = 250bar (3600psi) 350 = 350bar (5000psi)			Optional	Optional

## FLOW CHART

Standard Cv=3.5

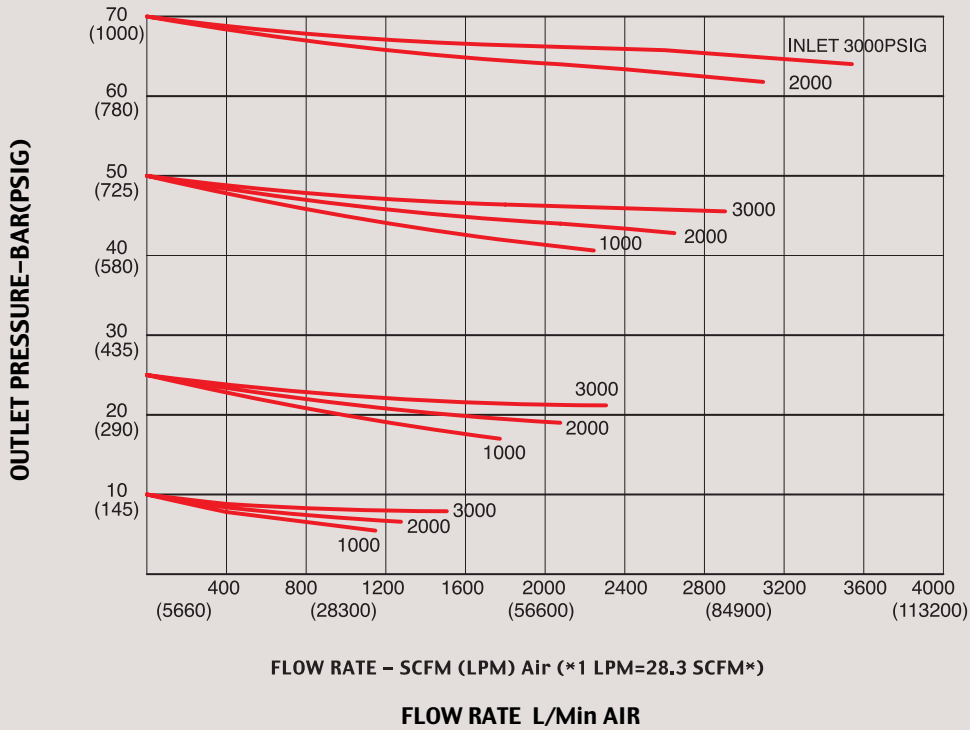

## SPECIFICATIONS

Ports	DR70x-SP-010 -NP2 3/4" NPT DR70x-SP-010 -BS2 3/4" BSP DR70x-SP-010 -NP3 1" NPT DR70x-SP-010 -BS3 1" BSP
Leak Rate Certification	to 2x10 <sup>-8</sup> atm cc/sec Helium available.
Body Materials	DR70x-BP-010 -NP2 Brass DR70x-SP-010 -NP2 Stainless steel 316L
Bonnet Material	Nickel Plated Brass / Stainless steel 316L(Optional)
Main Valve	Stainless steel 316L
Valve Spring	Stainless steel 316L(Optional)
Valve Seat	DR70x-SV-010 -NP2 VESPEL DR70x-SP-010 -NP2 TEFLON
Outlet Pressure Ranges	10bar(145psig), 25bar(362psig) 50bar(725psig), 70bar(1015psig)
Operating Temperature	-30°C ~ +60°C VITON / -40°C ~ +70°C TEFLON (standard)
Flow Capacity	Cv= 3.5 (Standard)