

Installation and Operation Manual

X-DPT-DeviceNet-GF100-Series-MFC-eng

Part Number: 541B184AAG

March, 2013

DeviceNet™ Supplemental Manual for GF100 Series Mass Flow Controllers and Meters



Brooks® GF135 Series and GF125 Series

Brooks DeviceNet PCs/PMs

Dear Customer,

We recommend that you read this manual in its entirety as this will enable efficient and proper use of the DeviceNet MFCs. Should you require any additional information concerning the DeviceNet MFCs, please feel free to contact your local Brooks Sales and Service Office; see back cover for contact information, or visit us on the web at www.BrooksInstrument.com. We appreciate this opportunity to service your fluid measurement and control requirements, and trust that we will be able to provide you with further assistance in future.

Yours sincerely,

Brooks Instrument

Contents

- 1. Introduction.....1**
 - 1.1. Device Profile –Enhanced Mass Flow Controller Device (Type 0x27).....3
 - 1.2. Object Model for Mass Flow Controller3
 - 1.3. How Objects Affect Behavior.....4

- 2. Identity Object (Class 0x01).....5**
 - 2.1. Instance Attributes.....5
 - 2.2. Common Services6

- 3. DeviceNet Object (Class 0x03).....7**
 - 3.1. Instance Attributes.....7
 - 3.2. Common Services8
 - 3.3. Semantics8
 - 3.4. Module Status LED.....9
 - 3.5. NET Status LED9

- 4. Connection Object (Class 0x05).....11**
 - 4.1. Instance Attributes (Explicit Connection, instance 111
 - 4.2. Instance Attributes (Polled Connection, instance 2)12
 - 4.3. Common Services14

- 5. Assembly Object (Class 0x04)15**
 - 5.1. Instance Attributes.....15
 - 5.2. Common Services16
 - 5.3. Object Instances.....16
 - 5.4. I/O Assembly Object Instance Data Attribute Format.....17

- 6. S-Device Supervisor Object (Class 0x30)23**
 - 6.1. S-Device Supervisor Class Attributes24
 - 6.2. S-Device Supervisor Instance Attributes (Object/Class 0x30).....25
 - 6.3. Semantics29
 - 6.4. S-Device Supervisor Common Services (Object/Class 0x30)36
 - 6.5. S-Device Supervisor Object-Specific Services.....36

Brooks DeviceNet PCs/PMs

7. S-Analog Sensor Object (Class 0x31)	39
7.1. S-Analog Sensor Class Attributes	39
7.2. S-Analog Sensor Instance Attributes (Object/Class 0x31).....	40
7.3. Semantics	45
7.4. S-Analog Sensor Common Services.....	49
7.5. S-Analog Sensor Object–Specific Services	49
7.5.1. Zero_Adjust Request Service Data Field Parameters	50
7.5.2. Gain_Adjust Request Service Data Field Parameters	50
7.6. Behavior.....	51
7.7. S-Analog Sensor Object Instance Subclass 01.....	52
7.7.1. Subclass 01 Instance Attributes	52
7.7.2. Subclass 01 Services	52
7.7.3. Subclass 01 Behavior.....	53
8. S-Analog Actuator Object (Class 0x32)	55
8.1. S-Analog Actuator Class Attributes	55
8.2. S-Analog Actuator Instance Attributes	56
8.3. Semantics	59
8.4. S-Analog Actuator Common Services.....	62
8.5. S-Analog Actuator Object–Specific Services	62
8.6. S-Analog Actuator Behavior	62
9. S-Single Stage Controller Object (Class 0x33)	65
9.1. S-Single Stage Controller Class Attributes.....	65
9.2. S-Single Stage Controller Instance Attributes	66
9.3. Semantics	69
9.4. S-Single Stage Controller Common Services	71
9.5. S-Single Stage Controller Object–Specific Services.....	72
9.6. Behavior.....	72
10. S-Gas Calibration Object (Class 0x34)	75
10.1. S-Gas Calibration Class Attributes	76
10.2. S-Gas Calibration Instance Attributes	77
10.3. Semantics	79
10.4. S-Gas Calibration Common Services.....	80
10.5. S-Gas Calibration Object–Specific Services	80
10.6. S-Gas Calibration Object Behavior	81

10.7. S-Gas Calibration Object Instance Subclass 01	82
10.7.1. Subclass01 Instance Attributes	82
10.7.2. Subclass 01 Instance Services	82
10.7.3. Subclass 01 Behavior	82
11. Advanced Diagnostics (GF135 Only)	83
11.1. New Communication Protocol Overview	83
11.1.1. Objectives and Problem Statement.....	83
11.1.2. Protocol Description	83
11.2. Specific Requirements.....	84
11.2.1. Introduction.....	84
11.2.2. Advanced Protocol	84
11.2.3. New Attributes	84
11.3. Tool – Device Communication.....	87
12. References	89

*THIS PAGE WAS
INTENTIONALLY
LEFT BLANK*

1. Introduction

This document and the DeviceNet Statement of Compliance (SOC) from the Open DeviceNet Vendors Association (ODVA) provide a complete interoperability specification for the GF135 Digital Mass Flow Controller device from Brooks. This device is defined by the ODVA specification in the Device Profiles chapter, section entitled "Enhance Mass Flow Controller, Type: 27_{hex}". Information contained in this document was derived from the following sources:

- DeviceNet Specification Enhancements for the S-Device Supervisor Objects:
 - S-Device Supervisor Object (DSE-93-01) ¹
 - S-Analog Sensor Object (DSE-93-02) ²
 - S-Analog Actuator Object (DSE-93-03) ³
 - S-Single Stage Controller Object (DSE-93-04) ⁴
 - S-Gas Calibrator Object (DSE-93-05) ⁵
- ODVA Mass Flow Controller Device Profile (DSE 93-06) ⁶
- ODVA DeviceNet Specifications Version 2.0 ⁷
- ODVA Enhanced Mass Flow Controller Device Profile (Edition 3.4, CIP Spec.)
- AMAT (various docs)

This device also complies with the ODVA Semiconductor SIG Interface Guidelines for DeviceNet Devices on Semiconductor Manufacturing Tools.

Brooks DeviceNet PCs/PMs

The GF100 Series Digital Mass Flow Controller (hereafter referred to as GF100 Series) supports the following DeviceNet objects: Identity, DeviceNet, Connection, and Assembly. In addition, support is also provided for the S-Device Supervisor, S-Analog Sensor, S-Analog Actuator, S-Single Stage Controller, and S-Gas Calibration objects. Supported objects are summarized in the following table.

Object Class	Subclass		Optional/Required	# of Instances
	Class	Inst		
Identity	-	-	Required	1
Message Router	-	-	Required	1
DeviceNet	-	-	Required	1
Connection	-	-	Required (note 1)	at least 1 I/O Polled and 1 Explicit
Acknowledge Handler Object	-	-	Conditional (note 2)	1
Assembly	-	-	Required	at least 1 Input and 1 Output
S-Device Supervisor	-	-	Required	1
S-Gas Calibration	-	01	Optional (Supported)	0 or More
S-Analog Sensor	-	01	Required (note 3)	3
S-Analog Actuator	-	-	Conditional (note 4) (Supported)	1
S-Single Stage Controller	-	-	Conditional (note 4) (Supported)	1

Notes:

1. *GF100 Series supports one I/O Polled and one Explicit Connection*
2. *Required for Change-of-State/Cyclic I/O connection support. (Not supported).*
3. *The GF100 Series supports three instances of the S-Analog Sensor object; instance 1 for flow, instance 2 for pressure and instance 3 for temperature. This conforms to the Enhanced MFC profile, device type = 27_{hex}.*
4. *Required for a Mass Flow Controller, a device that contains a Valve and a Controller. Not supported in a Mass Flow Meter Device (an MFC without a Valve or a Controller).*

1.1. Device Profile –Enhanced Mass Flow Controller Device (Type 0x27)

A Mass Flow Controller is a device that measures and controls the mass flow rate of gas or liquid. The MFC contains three principle components: a mass flow rate sensor, a metering valve, and a closed-loop controller. The sensor can consist of a variety of types, including thermal or pressure-based. Flow can be regulated by a variety of actuator types, including solenoid, voice coil, or piezoelectric transducer. The closed-loop controller accepts a setpoint from the host and controls the flow to that setpoint. Control is accomplished by monitoring the flow and adjusting the valve position to reduce the error between the setpoint flow value and actual flow value.

1.2. Object Model for Mass Flow Controller

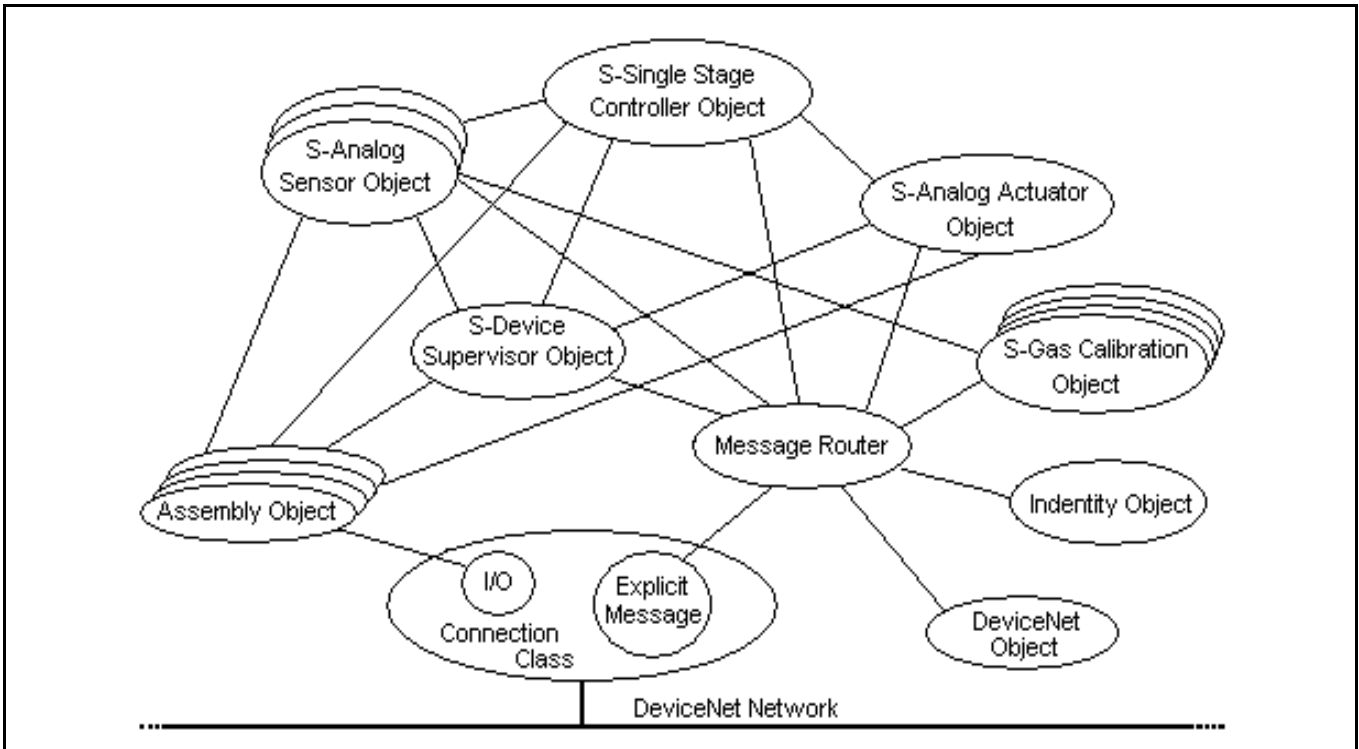

Object Model for the MFC Device

1.3. How Objects Affect Behavior

Object	Effect on behavior
Identity	Supports the Reset service. Upon receipt of a <i>Reset Service Request</i> of any <i>Type</i> , the Identity Object sends a <i>Reset Service Request</i> to the S-Device Supervisor.
Message Router	No effect
DeviceNet	Configures port attributes (node address, data rate, and BOI)
Connection Class	Contains the number of logical ports into or out of the device
Acknowledge Handler	Used to manage the reception of I/O message acknowledgements. (Not used or required in the GF100 Series).
Assembly	Defines input/output and configuration data format
S-Device Supervisor	Supports the Stop, Start, Reset, Abort, Recover and Perform_Diagnostic services for ALL Application Objects in the device and consolidates the Exception Conditions and Application Objects' Status. This object behaves differently from the Identity Object in that the S-Device Supervisor object provides a single point of access to the Application Objects only; it does not effect the DeviceNet specific objects (i.e., Identity, DeviceNet, Connection, etc.).
S-Gas Calibration	Modifies the correction algorithm of the S-Analog Sensor object which includes the selection mechanism to enable an S-Gas Calibration object instance.
S-Analog Sensor	Feeds the process variable to the Single Stage Controller object
S-Single Stage Controller	Feeds the control variable to the Analog Actuator object
S-Analog Actuator	Operates the Flow Control Valve of the device

2. Identity Object (Class 0x01)

The Identity Object provides general information about the identity of a device. This object is summarized in the following tables.

2.1. Instance Attributes

Attribute ID	Need in implementation	Access Rule	Name	DeviceNet Data Type	Description of Attribute
1	Required	Get	Vendor ID	UINT	ODVA Assigned Vendor Number = 41 (0x29)
2	Required	Get	Device Type	UINT	ODVA Assigned Device Number = 39 (0x27)
3	Required	Get	Product Code	UINT	Brooks Assigned Product Number = 724
4	Required	Get	Revision	STRUCT of:	Product Revision
			Major Rev	USINT	(byte)
			Minor Rev	USINT	(byte)
5	Required	Get	Status	WORD	DeviceNet Status
6	Required	Get	Serial Number	UDINT	DeviceNet Device Serial Number
7	Required	Get	Product Name	SHORT STRING	"GF100" (1-32 characters)

Brooks DeviceNet PCs/PMs

2.2. Common Services

Service Code	Need in Implementation		Service Name	Description of Service
	Class	Instance		
0Ehex 14dec	Conditional	Required	Get_Attributes_Single	Returns the contents of the specified attribute.
05hex 05dec	n/a	Required	Reset	Resets the device to the Self-Testing state.

RESET Request Service Data Field Parameters

Parameter	Required	Data Type	Description	Semantics of Values
Type	Required	USINT	Type of Reset	0 = Power Cycle type [default if parameter omitted] 1 = Out-of-Box type

3. DeviceNet Object (Class 0x03)

The DeviceNet Object maintains configuration and status of physical attachments to DeviceNet. It also allocates and releases connection instances associated with the Predefined Master/Slave Connection Set.

3.1. Instance Attributes

Attribute ID	Need in implementation	Access Rule	Name	DeviceNet Data Type	Description of Attribute
1	Required	Set	MAC ID	USINT (byte)	Values 0-63 or "P" (Programmable MAC ID) See "3.3. Semantics."
2	Required	Set	Baud Rate	USINT (byte)	Values 0,1,2 or "P" See "3.3. Semantics."
3	Required	Set	BOI	USINT (byte)	Bus Off Interrupt
4	Required	Set	Bus-off Counter	USINT (byte)	Number of times CAN chip went to bus off state
5	Required	Get	Allocation Information	USINT (byte)	Indicates whether or not the Predefined Master/Slave Connection Set has been allocated
6	Conditional (supported)	Get	MAC ID switch changed (note 1)	BOOL	Indicates the Node ID switches have changed since last power-up or reset. 0=no change, 1=change
7	Conditional (supported)	Get	Baud Rate switch changed (note 1)	BOOL	Indicates the baud rate switch has changed since last power-up or reset. 0=no change, 1=change
8	Conditional (supported)	Get	MAC ID switch value	USINT (byte)	Actual value of the Node address switches, (0-99)
9	Conditional (supported)	Get	Baud rate switch value	USINT (byte)	Actual value of the baud rate switch, (0-9)

Note 1: When either one of these two attributes are true (=1), then the module LED will flash red to indicate the status. See "3.4. Module Status LED" for more information.

Brooks DeviceNet PCs/PMs

3.2. Common Services

Service Code	Need in Implementation		Service Name	Description of Service
	Class	Instance		
0Ehex 14dec	Conditional	Required	Get_Attributes_Single	Returns the contents of the specified attribute.
10hex 16dec	n/a	Required	Set_Attributes_Single	Sets the attribute to the specified value
4Bhex 75dec	n/a	Required	Allocate_Master/Slave_Connection_Set	This is the Service utilized to perform the allocation of the Predefined Master/Slave Connection Set.
4Chex 76dec	n/a	Required	Release_Master/Slave_Connection_Set	This service is used to deallocate the Predefined Master/Slave Connection Set within a Slave

3.3. Semantics

The Mac ID and Baud Rate are switch selectable. Baud Rate will be 125K, 250K, or 500K baud if the switch is set to 1,2,5 respectively. The Mac Id switch sets the unit's DeviceNet address to 0-63, according to the switch settings. Both switches may be placed in the "P" position, which selects "programmable" Mac Id or Baud Rate. If the switch is placed in the "P" position, the Mac Id or Baud Rate will assume the last valid value.

Mac ID and Baud Rate attributes are software settable ONLY when the switches are in the "P" position. Behavior related to the Mac ID and the Baud Rate attributes conforms to the requirements defined in the *Open DeviceNet Vendor Association Semiconductor Special Interest Group (SIG) Interface Guidelines Conformance Test Procedure* (Section 5.6).

3.4. Module Status LED

The module status LED indicates the status of the DFC Module.

Module Status	LED State	Description
Power Off	Off	No Power applied to device
Device Self-test	Flashing Green-Red	Device is in Self-test. The Module LED will flash Green for 250mSec, followed by RED for 250mSec. If the device passes the self-test, LED will stay Green
Device Operational	Green	Device is operating normally.
Recoverable Fault	Flashing Red	The Node (MAC ID) address or baud rate switches have changed since the last power-up/reset.
Unrecoverable Fault	Red	Device has detected an unrecoverable fault.

3.5. NET Status LED

The Network status LED indicates the status of the DFC DeviceNet Connection.

Network Status	LED State	Description
Power Off	Off	No Power applied or device is the only node on the network.
On-line Not Connected	Flashing Green	Device is Operating normally. It is on-line, but no connections have been established to the Device.
Device Operational	Green	Device is operating normally.
Connection Timeout	Flashing Red	One or more connections have timed out.
Unrecoverable Fault	Red	Device cannot communicate on the network. Duplicate MacId or Bus-off condition

4. Connection Object (Class 0x05)

The Connection Class allocates and manages internal resources associated with both I/O and Explicit Messaging connections. The Explicit and I/O Connection Objects manage the communication aspects associated with a particular application to application network relationships. The GF100 Series supports both the Explicit and Polled or I/O Connections.

4.1. Instance Attributes (Explicit Connection, instance 1)

Attribute ID	Need in implementation	Access Rule	Name	DeviceNet Data Type	Description of Attribute
1	Required	Get	State	USINT (byte)	State of the object
2	Required	Get	Instance Type	USINT (byte)	Indicates either I/O or Messaging Connection
3	Required	Get	Transport Class Trigger	Byte	Defines behavior of the Connection
4	Required	Get	Produced Connection ID	UINT	Placed in CAN Identifier Field when connection transmits
5	Required	Get	Consumed Connection ID	UINT	CAN Identifier Field value that denotes message to be received
6	Required	Get	Initial Comm. Characteristics	Byte	Defines the Message Group(s) across which productions and consumptions associated with this Connection occur
7	Required	Get	Produced Connection Size	UINT	Maximum number of bytes transmitted across this connection
8	Required	Get	Consumed Connection Size	UINT	Maximum number of bytes transmitted across this connection
9	Required	Set	Expected Packet Rate	UINT	Defines timing associated with this Connection
12	Required	Get	Watchdog time-out Action	USINT (byte)	Defines how to handle Inactivity/Watchdog timeouts
13	Required	Get	Produced Path Length	UINT	Number of bytes in the produced_connection_path length

Brooks DeviceNet PCs/PMs

Attribute ID	Need in implementation	Access Rule	Name	DeviceNet Data Type	Description of Attribute
14	Required	Get	Produced Connection Path	Array of USINT	Specifies the Application Object(s) whose data is to be produced by this Connection Obj.
15	Required	Get	Consumed Path Length	UINT	Number of bytes in the consumed_connection_path attr.
16	Required	Get	Consumed Connection Path	Array of USINT	Specifies the Application Objs that are to receive data consumed by this Connection Obj.
17	Required	Get	Production Inhibit time	UINT	Defines minimum time between new data production. This attribute is required for I/O Client Connections.

4.2. Instance Attributes (Polled Connection, instance 2)

Attribute ID	Need in implementation	Access Rule	Name	DeviceNet Data Type	Description of Attribute
1	Required	Get	State	USINT (byte)	State of the object
2	Required	Get	Instance Type	USINT (byte)	Indicates either I/O or Messaging Connection
3	Required	Get	Transport Class Trigger	Byte	Defines behavior of the Connection, (server, class 2)
4	Required	Get	Produced Connection ID	UINT	Placed in CAN Identifier Field when connection transmits
5	Required	Get	Consumed Connection ID	UINT	CAN Identifier Field value that denotes message to be received
6	Required	Get	Initial Comm. Characteristics	Byte	Defines the Message Group(s) across which productions and consumptions associated with this Connection occur
7	Required	Get	Produced Connection Size	UINT	Maximum number of bytes transmitted across this connection

Attribute ID	Need in implementation	Access Rule	Name	DeviceNet Data Type	Description of Attribute
8	Required	Get	Consumed Connection Size	UINT	Maximum number of bytes transmitted across this connection
9	Required	Set	Expected Packet Rate	UINT	Defines timing associated with this Connection
12	Required	Get	Watchdog time-out Action	USINT (byte)	Defines how to handle Inactivity/Watchdog timeouts
13	Required	Get	Produced Path Length	UINT	Number of bytes in the produced_connection_path length
14	Required	Set *	Produced Connection Path	Array of USINT	Specifies the Application Object(s) whose data is to be produced by this Connection Obj.
15	Required	Get	Consumed Path Length	UINT	Number of bytes in the consumed_connection_path attr.
16	Required	Set*	Consumed Connection Path	Array of USINT	Specifies the Application Objs that are to receive data consumed by this Connection Obj.
17	Required	Get	Production Inhibit time	UINT	Defines minimum time between new data production. This attribute is required for I/O Client Connections.

** Produced and Consumed Connection Path attributes are settable ONLY when the I/O connection is in the "Configuring" State. These attributes must reference consistent data types at the time the I/O connection transitions to the Established State. See MFC Device Profile, Version J for more information regarding consistent data types.*

Brooks DeviceNet PCs/PMs

4.3. Common Services

Service Code	Need in Implementation		Service Name	Description of Service
	Class	Instance		
0Ehex 14dec	Conditional	Required	Get_Attributes_Single	Returns the contents of the specified attribute.
10hex 16dec	n/a	Required	Set_Attributes_Single	Sets the attribute to the specified value
05hex 05dec	n/a	Optional (supported)	Reset	Dependent on watchdog timeout action.

5. Assembly Object (Class 0x04)

The Assembly Object groups attributes of multiple objects into a single block of data, which can be produced and consumed over an I/O connection. Various combinations of S-Device Supervisor Attributes are grouped together to form the assemblies supported by the GF100 Series. Both the MFC and EMFC device profiles do NOT allow “mixed” integer and real assemblies to be allowed at the same time. That is, it is not allowed to produce an integer assemble and consume a floating-point assembly over a polled connection. See the EMFC Device Profile in the ODVA DeviceNet specification for more detail.

5.1. Instance Attributes

Number	Required	Supported	Type	# bytes	Name
1	N	Y	Input	2	Flow
2	Y (default)	Y	Input	3	Status and Flow
3	N	Y	Input	5	Status, Flow and Valve
4	N	Y	Input	5	Status, Flow, and Setpoint
5	N	Y	Input	7	Status, Flow, Setpoint and Valve
6	Y	Y	Input	8	Status, Flow, Setpoint, Override and Valve
7	Y (default)	Y	Output	2	Setpoint
8	Y	Y	Output	3	Override and Setpoint
9	N	Y	Input	1	Status
10	-	N	-	-	(assembly not used)
11	-	N	-	-	(assembly not used)
12	-	N	-	-	(assembly not used)
13	N	Y	Input	4	FP Flow
14	Y	Y	Input	5	Status, FP Flow
15	N	Y	Input	9	Status, FP Flow and FP Valve
16	N	Y	Input	9	Status, FP Flow, and FP Setpoint
17	N	Y	Input	13	Status, FP Flow, FP Setpoint and FP Valve
18	Y	Y	Input	14	Status, FP Flow, FP Setpoint, Override and FP Valve
19	Y	Y	Output	4	FP Setpoint
20	Y	Y	Output	5	Override and FP Setpoint

Brooks DeviceNet PCs/PMs

Number	Required	Supported	Type	# bytes	Name
21	Y	Y	Input	7	Status, Flow, Pressure, Temperature
22	Y	Y	Input	9	Status, Flow, Valve, Pressure, Temperature
23	Y	Y	Input	13	Status, FP Flow, FP Pressure, and FP Temperature

The number of bytes indicates how many data bytes are produced or consumed for each assembly. The “FP” abbreviation is for Floating Point, or real data. Each real data value will consist of 4 bytes of IEEE 754 single precision data.

5.2. Common Services

Service Code	Need in Implementation		Service Name	Description of Service
	Class	Instance		
0Ehex 14dec	Conditional	Required	Get_Attributes_Single	Returns the contents of the specified attribute.

5.3. Object Instances

Producing Object Instances must be one of the following: 1, 2, 3, 4, 5, 6, 9, 13, 14, 15, 16, 17, 18, 21, 22 or 23. These instances send data to the master. Consuming Object Instances must be one of the following: 7, 8, 19, or 20. These instances receive data from the master. As mentioned before, both the Produced and Consumed Paths must reference either integer OR real assemblies. The following section details each assembly and its data type. The “FP” designation will indicate a real, floating point value. Otherwise, the data will be an integer or, in the case of the “status” byte, a bit-mapped value.

5.4. I/O Assembly Object Instance Data Attribute Format

The manufacturer of a Mass Flow Controller Device must specify which Assembly instances are supported by the device. The GF100 Series supports the following assemblies.

The I/O Assembly DATA attribute has the format shown below.

Instance	Byte	Bit 7	Bit 6	Bit 5	Bit 4	Bit 3	Bit 2	Bit 1	Bit 0
1	0	Flow (low byte)							
	1	Flow (high byte)							
2	0	Status							
	1	Flow (low byte)							
	2	Flow (high byte)							
3	0	Status							
	1	Flow (low byte)							
	2	Flow (high byte)							
	3	Valve (low byte)							
	4	Valve (high byte)							
4	0	Status							
	1	Flow (low byte)							
	2	Flow (high byte)							
	3	Setpoint (low byte)							
	4	Setpoint (high byte)							
5	0	Status							
	1	Flow (low byte)							
	2	Flow (high byte)							
	3	Setpoint (low byte)							
	4	Setpoint (high byte)							
	5	Valve (low byte)							
	6	Valve (high byte)							

Brooks DeviceNet PCs/PMs

Instance	Byte	Bit 7	Bit 6	Bit 5	Bit 4	Bit 3	Bit 2	Bit 1	Bit 0
6	0	Status							
	1	Flow (low byte)							
	2	Flow (high byte)							
	3	Setpoint (low byte)							
	4	Setpoint (high byte)							
	5	Override							
	6	Valve (low byte)							
	7	Valve (high byte)							
7	0	Setpoint (low byte)							
	1	Setpoint (high byte)							
8	0	Override							
	1	Setpoint (low byte)							
	2	Setpoint (high byte)							
9	0	Status							
10	-	The assembly instances							
11	-	10, 11 and 12							
12	-	are not used in the EMFC implementation.							
13	0	FP Flow (low byte)							
	1	FP Flow							
	2	FP Flow							
	3	FP Flow (high byte)							
14	0	Status							
	1	FP Flow (low byte)							
	2	FP Flow							
	3	FP Flow							
	4	FP Flow (high byte)							

Instance	Byte	Bit 7	Bit 6	Bit 5	Bit 4	Bit 3	Bit 2	Bit 1	Bit 0
15	0	Status							
	1	FP Flow (low byte)							
	2	FP Flow							
	3	FP Flow							
	4	FP Flow (high byte)							
	5	FP Valve (low byte)							
	6	FP Valve							
	7	FP Valve							
	8	FP Valve (high byte)							
16	0	Status							
	1	FP Flow (low byte)							
	2	FP Flow							
	3	FP Flow							
	4	Flow (high byte)							
	5	FP Setpoint (low byte)							
	6	FP Setpoint							
	7	FP Setpoint							
	8	FP Setpoint (high byte)							

Brooks DeviceNet PCs/PMs

Instance	Byte	Bit 7	Bit 6	Bit 5	Bit 4	Bit 3	Bit 2	Bit 1	Bit 0
17	0	Status							
	1	FP Flow (low byte)							
	2	FP Flow							
	3	FP Flow							
	4	FP Flow (high byte)							
	5	FP Setpoint (low byte)							
	6	FP Setpoint							
	7	FP Setpoint							
	8	FP Setpoint (high byte)							
	9	FP Valve (low byte)							
	10	FP Valve							
	11	FP Valve							
	12	FP Valve (high byte)							
18	0	Status							
	1	FP Flow (low byte)							
	2	FP Flow							
	3	FP Flow							
	4	FP Flow (high byte)							
	5	FP Setpoint (low byte)							
	6	FP Setpoint							
	7	FP Setpoint							
	8	FP Setpoint (high byte)							
	9	Override							
	10	FP Valve (low byte)							
	11	FP Valve							
	12	FP Valve							
	13	FP Valve (high byte)							

Instance	Byte	Bit 7	Bit 6	Bit 5	Bit 4	Bit 3	Bit 2	Bit 1	Bit 0
19	0	FP Setpoint (low byte)							
	1	FP Setpoint							
	2	FP Setpoint							
	3	FP Setpoint (high byte)							
20	0	Override							
	1	FP Setpoint (low byte)							
	2	FP Setpoint							
	3	FP Setpoint							
	4	FP Setpoint (high byte)							
21	0	Status							
	1	Flow (low byte)							
	2	Flow (high byte)							
	3	Pressure (low byte)							
	4	Pressure (high byte)							
	5	Temperature (low byte)							
	6	Temperature (high byte)							
22	0	Status							
	1	Flow (low byte)							
	2	Flow (high byte)							
	3	Valve (low byte)							
	4	Valve (high byte)							
	5	Pressure (low byte)							
	6	Pressure (high byte)							
	7	Temperature (low byte)							
	8	Temperature (high byte)							

Brooks DeviceNet PCs/PMs

Instance	Byte	Bit 7	Bit 6	Bit 5	Bit 4	Bit 3	Bit 2	Bit 1	Bit 0
23	0	Status							
	1	FP Flow (low byte)							
	2	FP Flow							
	3	FP Flow							
	4	FP Flow (high byte)							
	5	FP Pressure (low byte)							
	6	FP Pressure							
	7	FP Pressure							
	8	FP Pressure (high byte)							
	9	FP Temperature (low byte)							
	10	FP Temperature							
	11	FP Temperature							
	12	FP Temperature (high byte)							

6. S-Device Supervisor Object (Class 0x30)

This object models the interface, functions and behavior associated with the management of application objects for devices within the “*Hierarchy of Semiconductor Equipment Devices*”. Throughout this DeviceNet Standard, objects belonging to this hierarchy are identified as such by a naming convention that includes a prefix of “S-” in the object class name. This “*Hierarchy of Semiconductor Equipment Devices*” is completely defined in this object definition such that all objects belonging to this hierarchy require the existence of an S-Device Supervisor object to manage its functions and behaviors.

The S-Device Supervisor object centralizes application object state definitions and related status information, exception status indications (alarms and warnings), and defines a behavior model which is assumed by objects identified as belonging to the *Hierarchy of Semiconductor Equipment Devices*. If a reset is requested of the S-Device Supervisor object instance, it will reset this object instance as well as all of its associated application objects.

Similarly, the Identity object provides an interface to the S-Device Supervisor object. A reset request to the Identity object (of any type) causes a reset request to the S-Device Supervisor object. Further relationships are specified in the Behavior section below.

Additionally, some device attributes are defined which are required in order to specify device models such that they are compliant with the SEMI S/A Network Standard *, from which the *Hierarchy of Semiconductor Equipment Devices* is derived. Objects defined to exist within the *Hierarchy of Semiconductor Equipment Devices* are done so in order to simplify the management and description of object behavior while insuring compliance with the SEMI Standard.

NOTE: By association with this object, the Start, Stop, Reset, Abort, Recover and Perform_Diagnostic Services are inherently supported by all objects within the *Hierarchy of Semiconductor Equipment Devices*. These services are not accessible over the network for the associated object instances.

* Semiconductor Equipment and Materials International, Mountain View CA, Standard E54: *Sensor/Actuator Network Common Device Model*.

Brooks DeviceNet PCs/PMs

6.1. S-Device Supervisor Class Attributes

The Object Class Attribute ID 1-7 are reserved. See DeviceNet Volume II, Section 5-4.1. for more specification detail on these attributes.

Attribute ID	Need in Implementation	Access Rule	Name	DeviceNet Data Type	Description of Attribute
1 thru 7	These class attributes are either optional or conditional and are described in chapter 5 of this specification.				
97 & 98	Reserved by DeviceNet				
99	Conditional *	Get	Subclass	UINT	Identifies a subset of additional attributes, services and behaviors. The subclasses for this object are specified at the end of this object specification section.

** If the value of Subclass is 00 which identifies "no subclass", then this attribute is OPTIONAL in implementation, otherwise, this attribute is REQUIRED.*

6.2. S-Device Supervisor Instance Attributes (Object/Class 0x30)

DeviceNet reserves Attribute ID 100-199 (64_{hex}-C7_{hex}) for Vendor Defined Attributes. See Volume II, Section 7 for more information on Object Definitions.

Note: All required attributes are supported. Optional attributes are indicated as (Supported) or (Not Supported).

Attr ID	Need in Implementation	Access Rule	NV*	Name	DeviceNet Data Type	Description of Attribute
1	Optional (Not Supported)	Get	NV	Number of Attributes	USINT (byte)	Number of Attributes supported by the object instance
2	Optional (Not Supported)	Get	NV	Attribute List	Array of USINT (bytes)	List of attributes supported by the object instance
3	Required	Get	NV	Device Type	SHORT STRING	ASCII Text, Max. 8 Characters, See "6.3. Semantics."
4	Required	Get	NV	SEMI Standard Revision Level	SHORT STRING	Specifies the revision level of the SEMI S/A Network Standard to which the device complies. For this revision, this attribute must be: "E54-0997"
5	Required	Get	NV	Manufacturer's Name	SHORT STRING	ASCII Text, Max. 20 Characters. See "6.3. Semantics."
6	Required	Get	NV	Manufacturer's Model Number	SHORT STRING	ASCII Text, Max. 20 Characters, Manufacturer Specified.
7	Required	Get	NV	Software Revision Level	SHORT STRING	ASCII Text, Max. 6 Characters. See "6.3. Semantics."
8	Required	Get	NV	Hardware Revision Level	SHORT STRING	ASCII Text, Max. 6 Characters, see "Semantics" section
9	Optional (Supported)	Get	NV	Manufacturer's Serial Number	SHORT STRING	ASCII Text, Max. 30 Characters, Manufacturer Specified. See "6.3. Semantics."
10	Optional (Supported)	Get	NV	Device Configuration	SHORT STRING	ASCII Text, Max. 50 Characters, Manufacturer Specified. Optional additional information about the device configuration.
11	Required	Get	V	Device Status	USINT (byte)	See "6.3. Semantics."
12	Required	Get	V	Exception Status	BYTE	See "6.3. Semantics"

Brooks DeviceNet PCs/PMs

Attr ID	Need in Implementation	Access Rule	NV*	Name	DeviceNet Data Type	Description of Attribute
13	Conditional based on Exception Status Bit 7 (Supported)	Get	V	Exception Detail Alarm	STRUCT of:	A Structure of three Structures containing a bit mapped representation of the alarm detail
				Common Exception Detail	STRUCT of:	
				Size	USINT (byte)	Number of Common Detail Bytes (size = 2)
				Detail	ARRAY of:	See "6.3. Semantics."
				Detail n	BYTE	See "6.3. Semantics."
				Device Exception Detail	STRUCT of:	
				Size	USINT (byte)	Number of Device Detail Bytes (size = 2)
				Detail	ARRAY of:	See Device Profile
				Detail n	BYTE	See Device Profile
				Manufacturer Exception Detail	STRUCT of:	
				Size	USINT (byte)	Number of Manufacturer Detail Bytes (size = 1)
				Detail n	BYTE	Manufacturer Specified

Note: The Enhanced (Next Generation) MFC Device Profile specifies two bytes of Common Detail, two bytes of Device Exception Detail, and one byte of Manufacturer Specified Detail. See "6.3. Semantics" for more information.

Attr ID	Need in implementation	Access Rule	NV*	Name	DeviceNet Data Type	Description of Attribute
14	Conditional based on Exception Status Bit 7 (Supported)	Get	V	Exception Detail Warning	STRUCT of:	A Structure of three Structures containing a bit mapped representation of the warning detail
				Common Exception Detail	STRUCT of:	
				Size	USINT (byte)	Number of Common Detail Bytes (size = 2)
				Detail	ARRAY of:	See "6.3. Semantics."
				Detail n	BYTE	See "6.3. Semantics."
				Device Exception Detail	STRUCT of:	
				Size	USINT (byte)	Number of Device Detail Bytes (size = 2)
				Detail	ARRAY of:	See Device Profile
				Detail n	BYTE	See Device Profile
				Manufacturer Exception Detail	STRUCT of:	
				Size	USINT (byte)	Number of Manufacturer Detail Bytes (size = 1)
				Detail n	BYTE	Manufacturer Specified

Note: The Enhanced (Next Generation) MFC Device Profile specifies two bytes of Common Detail, two bytes of Device Exception Detail, and one byte of Manufacturer Specified Detail. See "6.3. Semantics" for more information.

Brooks DeviceNet PCs/PMs

Attr ID	Need in implementation	Access Rule	NV*	Name	DeviceNet Data Type	Description of Attribute
15	Required	Set	NV	Alarm Enable	BOOL	See "6.3. Semantics."
16	Required	Set	NV	Warning Enable	BOOL	See "6.3. Semantics."
17	Optional (Not Supported)	Set	**	Time	DATE_AND_TIME	The value of the device's internal real-time clock. See "6.3. Semantics."
18	Optional (Not Supported)	Get	NV	** Clock Behavior	USINT (byte)	0 = [default] clock always resets during power cycle 1 = clock value is stored in non-volatile memory at power down 2 = clock is battery-backed and runs without device power. 3-255 - not defined
19	Optional (Not Supported)	Get	NV	Last Maintenance Date	DATE	The date on which the device was last serviced.
20	Optional (Not Supported)	Get	NV	Next Scheduled Maintenance Date	DATE	The date on which it is recommended that the device next be serviced.
21	Optional (Not Supported)	Get	NV	Scheduled Maintenance Expiration Timer	INT	See "6.3. Semantics."
22	Conditional – Required if Calibration Expiration is supported (Not Supported)	Set	NV	Scheduled Maintenance Expiration Warning Enable	BOOL	See "6.3. Semantics."
23	Optional (Not Supported)	Get	NV	Run Hours	UDINT	An indication of the number of hours that the device has had power applied. It has a resolution of 1 hour. This value shall be maintained in nonvolatile memory.

Attr ID	Need in implementation	Access Rule	NV*	Name	DeviceNet Data Type	Description of Attribute
97-98	Reserved by DeviceNet					
99	Conditional ** (Supported)	Get	NV	Subclass	UINT	Identifies a subset of additional attributes, services and behaviors. The subclasses for this object are specified at the end of this object specification section.

* NV = Nonvolatile; attribute value is maintained through power cycles; V = Volatile

** If the value of Subclass is 00 which identifies "no subclass", then this attribute is OPTIONAL in implementation, otherwise, this attribute is REQUIRED.

6.3. Semantics

Device Type

The Device Type attribute identifies the Specific Device Model to which the device is modeled within the Hierarchy of Semiconductor Equipment Devices. The value of this string is specified in the SEMI standard suite referenced in the introduction section of this object definition and is represented for reference in the applicable device profile where used.

Manufacturer's Name

The Manufacturer's Name attribute identifies the manufacturer of the device. It is the responsibility of the manufacturer to insure that this ASCII coded text string is sufficiently long to insure uniqueness among manufacturers.

The Device Manufacturer attribute is not guaranteed, by specification, to be unique. Therefore, it is not a substitute for the corresponding attribute of the Identity Object and should not be used for identification purposes.

Software Revision Level

This is an ASCII coded text string representing the revision of the software corresponding to the specific device identified by the Identity object and the S-Device Supervisor object.

Hardware Revision Level

This is an ASCII coded text string representing the revision of the hardware, which is identified by the Identity object and the S-Device Supervisor object. The manufacturer of the device must control this revision such that modifications to the device hardware may be tracked.

Manufacturer's Serial Number

This attribute is a string representation of the manufacturer's serial number of the device, formatted to fit the appropriate manufacturing tracking systems. This is not the same as the Identity Object's serial number, which is used to uniquely identify the device in the network environment.

Device Status

This attribute represents the current state of the device. Its value changes as the state of the device changes. The following values are defined:

Attribute Value	State
0	Undefined
1	Self Testing
2	Idle
3	Self-Test Exception
4	Executing
5	Abort
6	Critical Fault
7-50	Reserved by DeviceNet
51-99	Device Specific (None Used)
100-255	Vendor Specific (None Used)

Exception Status

A single byte attribute whose value indicates that the status of the alarms and warnings for the device. This indication may be provided in one of two methods: Basic or Expanded.

For the *Basic Method*, bit seven of the Exception Status attribute is set to zero; all exceptions are reported exclusively through communication of this Exception Status attribute. The format of bits zero through six in this mode is device specific; the format may be further specified in an appropriate device profile specification; if it is not specified, then the format of bits zero through six is equivalent to that specified for the expanded method.

For the *Expanded Method*, bit seven of Exception Status attribute is set to one; exceptions are reported through the communication of this Exception Status attribute, formatted as specified in the table below. In addition, the Exception Detail attributes are supported. The Exception Status bits are determined by a logical “OR” of the related Exception Detail bits, as indicated.

Bit	Exception Status Bit Map, Bit 7 set to 1
	Function
0	ALARM/device-common*
1	ALARM/device-specific
2	ALARM/manufacturer-specific
3	reserved -- set to 0
4	WARNING/device-common*
5	WARNING/device-specific
6	WARNING/manufacturer-specific
7	1 == Expanded Method

* The alarm or warning is not specific to the device type or device type manufacturer.

Exception Detail Alarm and Exception Detail Warning

The formats of these two attributes are identical. Therefore, they are described together here:

Attributes that relate the detailed status of the alarms or warnings associated with the device. Each attribute is a structure containing three members; these three members respectively relate the detailed status of exceptions that are common (i.e., not device-specific), device-specific but not manufacturer-specific, and manufacturer-specific. The common detail is defined below. The device-specific detail is defined in the appropriate Device Profile. The manufacturer defines the manufacturer-specific detail. A SIZE value of zero indicates that no detail is defined for the associated exception detail structure.

Each of the three structure members is defined as a structure containing an ordered list (i.e., array) of bytes of length SIZE, and an unsigned integer whose value is SIZE. Each of the bytes in each array has a specific mapping. This mapping is formatted as 8 bits, which represents 8 independent conditions. A value of 1 indicates that the condition is set (or present), and a value of 0 indicates that the condition is cleared (or not present). Note that if a device does not support an exception detail, the corresponding bit is never set. The bitmaps for alarms and warnings in the corresponding attributes are structured in parallel so that a condition may have either alarm or warning set depending on severity. If a condition inherently cannot be both alarm and warning, then the parallel bit position corresponding to the other state will remain "0."

The existence of an exception detail variable structure is dependent on the value of the Exception Status Attribute. The existence of an exception detail variable structure is only required if bit seven of the Exception Status attribute is set to 1, indicating the Expanded method reporting. Bits 0-6 of the Exception Status attribute correspond to the particular exception type.

Common Exception Detail

This structure relates exception conditions (i.e., alarms or warnings) which are common to all devices within the *Hierarchy of Semiconductor Equipment Devices*. The Detail element of the structure is an ordered list (i.e., array) of bytes of length [SIZE], which is the value of the structure element Size. For each byte in the Detail field, all bits not identified are reserved for future standardization.

The first byte in this attribute is CommonExceptionDetail[0]. Additional exception details, if provided, are named CommonExceptionDetail[1], . . . CommonExceptionDetail[SIZE]. The specific exception associated with each of the bitmaps is given in the table below. The SIZE for this revision is two, (2). The criteria details for each exception condition are outside the scope of this document. If a device does not support an exception detail, the corresponding bit is never set.

Common Exception Detail Attribute Values

Bit	Common Exception Detail [0]*
0	internal diagnostic exception
1	Microprocessor exception
2	EPROM exception
3	EEPROM exception (**)
4	RAM exception
5	Reserved by DeviceNet
6	Internal real-time exception
7	Reserved by DeviceNet

** Exception Supported

Bit	Common Exception Detail [1]*
0	power supply overcurrent
1	reserved power supply
2	power supply output voltage (**)
3	power supply input voltage
4	scheduled maintenance due
5	notify manufacturer
6	reset exception
7	reserved by DeviceNet

** Exception Supported

Device Exception Detail

This structure, similar in form to Common Exception Detail, relates exception conditions, which are specific to individual devices on the network and are defined in their respective device profiles. The Detail element of the structure is an ordered list (i.e., array) of bytes of length [SIZE], which is the value of the structure element size. For a detailed description of this attribute, consult the appropriate specific device profile.

Note: The MFC profile has been updated and device exception detail has been modified to accommodate the extra instances in the S-Analog Sensor Object.

Manufacturer Exception Detail

This structure, similar in form to Common Exception Detail, relates exception conditions, which are specific to the manufacturers of individual devices on the network and are defined by them in their product documentation. The Detail element of the structure is an ordered list (i.e., array) of bytes of length [SIZE], which is the value of the structure element Size. For a detailed description of this attribute, consult the appropriate specific device manufacturer documentation.

Exception Detail Format Summary

Data Component	Bit 7	Bit 6	Bit 5	Bit 4	Bit 3	Bit 2	Bit 1	Bit 0
MFC Device Exception Detail Size	0	0	0	0	0	0	1	0
MFC Device Exception Detail Byte 0	Reserved 0	Reserved 0	Valve High S-Analog Actuator	Valve Low S-Analog Actuator	Flow Control S-Single Stage Controller	Flow High S-Analog Sensor	Flow Low S-Analog Sensor	Not Reading Valid* S-Analog Sensor
MFC Device Exception Detail Byte 1	Reserved 0	Reserved 0	Not Reading Valid S-Analog Sensor temperature	Not Reading Valid S-Analog Sensor pressure	Gas Temp High S-Analog Sensor Instance 3	Gas Temp Low S-Analog Sensor Instance 3	Pressure High S-Analog Sensor Instance 2	Pressure Low S-Analog Sensor Instance 2
Manufacturer Exception Detail Size	0	0	0	0	0	0	0	1
Manufacturer Exception Detail	0	0	0	0	0	0	0	0

* Only used in the Warning Exception Detail, this bit is always = 0 in the Alarm Exception Detail.

- **Valve High** indicates that the Actuator current has exceeded the upper alarm or warning limit.
- **Valve Low** condition never occurs, because low valve current is not an alarm or warning condition.
- **Flow Control** indicates that the closed-loop control system is not able to control the flow within the desired specification. The GF100 Series only supports the alarm condition.
- **Flow High** indicates that the sensor resistance has exceeded the upper alarm or warning limit.
- **Flow Low** indicates that the sensor resistance has fallen below the lower alarm or warning limit.

Alarm Enable and Warning Enable

These Boolean attributes are used to enable (1) or disable (0) the S-Device Supervisor object's process of setting Exception bits. When disabled, corresponding bits are never set; and, if they were set, disabling clears them. Also, alarm and warning states are not retained; when enabled, bits will be set only if the corresponding condition is true.

The default-state for these Enable attributes is enabled (1).

Time

This optional attribute represents the value of the time and date as maintained by the device's realtime clock with a resolution of one millisecond.

The default value for the Time attribute is zero (0), corresponding to 12:00AM, January 1, 1972, as specified by DeviceNet Volume I, Appendix J.

Scheduled Maintenance Expiration Timer

This attribute, with a resolution of one hour, is used to cause a warning, which indicates that a device calibration is due. A S-Device Supervisor timer decrements this attribute once per hour while power is applied. When the attribute is no longer positive and the Scheduled Maintenance Expiration Warning Enable attribute is set to enabled, a Scheduled Maintenance Expiration Warning condition is generated. This causes the Scheduled Maintenance Due Warning bit to be set.

The attribute will not wrap; when the attribute reaches its most negative value, it no longer decrements. The attribute will continue to decrement irrespective of the state of the Scheduled Maintenance Expiration Warning Enable attribute. The value shall be maintained in nonvolatile memory.

Scheduled Maintenance Expiration Warning Enable

This Boolean attribute is used to enable (1) or disable (0) the S-Device Supervisor object's process of setting the Scheduled Maintenance Due Exception bit. When disabled, the corresponding bit is never set; and, if it was set, disabling clears it. When enabled, the bit will be set only if the corresponding condition is true.

The default-state for this Enable attribute is enabled (1).

Brooks DeviceNet PCs/PMs

6.4. S-Device Supervisor Common Services (Object/Class 0x30)

Service Code	Need in Implementation		Service Name	Description of Service
	Class	Instance		
0Ehex 14dec	Conditional	Required	Get_Attributes_Single	Returns the contents of the specified attribute.
10hex 16dec	n/a	Required	Set_Attributes_Single	Modifies an attribute value.
5	n/a	Required	Reset	Resets the device to the Self-Testing state.
6	n/a	Required	Start	Starts the device execution by moving the device to the Executing state. Equivalent to SEMI S/A Network Execute Service
7	n/a	Optional Supported	Stop	Moves the device to the Idle state

See the DeviceNet Communication Model and Protocol for definitions of these common services.

6.5. S-Device Supervisor Object-Specific Services

Service Code	Need in Implementation		Service Name	Description of Service
	Class	Instance		
4Bhex 75dec	n/a	Required	Abort	Moves the device to the Abort state
4Chex 76dec	n/a	Required	Recover	Moves the device out of the Abort state
4Ehex 78dec	n/a	Required	Perform_Diagnostics	Causes the device to perform a set of diagnostic routines

DS Object Service Parameter Dictionary

Parameter	Form	Description
TestID	USINT (byte)	Type and possibly detail of diagnostic test to be performed

Abort — Used to transition the device application objects to the aborted state. This service request may be (and generally will be) originated internally, from application objects.

Recover — Used to transition the device application objects from the abort state to the idle state. This service request may be originated internally, from application objects.

Perform_Diagnostics — Used to instruct the S-Device Supervisor object to perform a diagnostic test. A diagnostic test is either of type *common* or *device-dependent*. *Common* diagnostic tests include RAM, EPROM, non-volatile memory, and communications. *Common* diagnostic tests are implementation-specific. All detail of *device-dependent* diagnostics is outside the scope of this document.

TestID Parameter

The following values are defined for the TestID parameter for the Perform_Diagnostics Service Request:

Attribute Value	State
0	Standard
1-63	Reserved
64-127	Device Specific (defined in Device Profile)
128-255	Manufacturer Specific (defined by manufacturer)

Type “Standard” is specified if there is only one type of diagnostic defined or if there is more than one including a type standard. Additional diagnostic types may be defined in the device profile or by the manufacturer.

*THIS PAGE WAS
INTENTIONALLY
LEFT BLANK*

7. S-Analog Sensor Object (Class 0x31)

The S-Analog Sensor Object models the acquisition of a reading from a physical sensor in a device. Associated with an analog sensor is a reading that has been acquired and corrected with an offset and a gain coefficient, optionally, settable in the object. Additional correction algorithms may be specified by other objects identified in the device profile or as extensions specified by the manufacturer.

The GF100 Series supports three instances of the S-Analog Sensor Object. Instance 1 is associated with the flow sensor. Instance 2 is associated with the pressure sensor. Instance 3 is associated with the temperature sensor.

This object is a member of the *Hierarchy of Semiconductor Equipment Devices*. The S-Device Supervisor Object manages the behavior of the S-Analog Sensor Object. See Section 6 of this document.

7.1. S-Analog Sensor Class Attributes

The Object Class Attribute ID 1-7 are reserved. See DeviceNet Volume II, Section 5-4.1. for more specification detail on these attributes.

Attribute ID	Need in Implementation	Access Rule	Name	DeviceNet Data Type	Description of Attribute
1 thru 7	These class attributes are either optional or conditional and are described in chapter 5 of this specification.				
97 & 98	Reserved by DeviceNet				
99	Conditional * (Supported)	Get	Subclass	UINT	Identifies a subset of additional attributes, services and behaviors. The subclasses for this object are specified at the end of this object specification section.

* If the value of Subclass is 00, which identifies "no subclass", then this attribute is OPTIONAL in implementation, otherwise, this attribute is REQUIRED.

Brooks DeviceNet PCs/PMs

7.2. S-Analog Sensor Instance Attributes (Object/Class 0x31)

Certain minimal implementations may support any optional “Set” attributes as “Get Only” and still be compliant with this object specification. All required attributes must be supported as specified. Not all attributes are supported for all instances.

Attr ID	Need in Implementation	Access Rule	NV*	Name	DeviceNet Data Type	Description of Attribute	Semantics of Values
1	Optional (Not Supported)	Get	NV	Number of Attributes	USINT (byte)	Number of attributes supported	The number of attributes supported by this object instance
2	Optional (Not Supported)	Get	NV	Attribute List	ARRAY OF USINT (bytes)	List of attributes supported by this object instance	List of attributes supported by this object instance
3	Optional (Supported)	See Semantics Set ¹	NV	Data Type	USINT (byte)	Determines the Data Type of <i>Value</i> and all related attributes as specified in this table.	See “7.3. Semantics.” [default] = INT INT and Real supported
4	Optional (Supported)	See Semantics Set ¹	NV	Data Units	UINT	Determines the Units context of <i>Value</i> and all related attributes.	See “7.3. Semantics.” [default] = Counts Counts or SCCM supported
5	Required	Get	V	Reading Valid	BOOL	Indicates that the <i>Value</i> attribute contains a valid value.	0 = invalid 1 = valid (invalid: e.g., not warmed up yet)
6	Required	Get	V	Value	INT or specified by <i>Data Type</i> if supported	Analog input value	The corrected, converted, calibrated final value of the sensor. Range is one of: 0-6000H (0 – 100%) 0-7FFFH (0-100%) See “7.3. Semantics.”
7	Required	Get	V	Status	BYTE	Alarm/Warning State of this object instance	See “7.3. Semantics.”
8	Optional (Supported)	Set	NV	Alarm Enable	BOOL	Enables the setting of the Alarm Status Bits	0 = disable [default] 1 = enable
9	Optional (Supported)	Set	NV	Warning Enable	BOOL	Enables the setting of the Warning Status Bits	0 = disable [default] 1 = enable

Attr ID	Need in Implementation	Access Rule	NV*	Name	DeviceNet Data Type	Description of Attribute	Semantics of Values
10	Optional (Supported)	Get	NV	Full Scale	INT or specified by <i>Data Type</i> if supported	The <i>Value</i> of Full Scale for the sensor.	The value of attribute <i>Value</i> corresponding to the Full Scale calibrated measurement of the sensor. [default] = maximum allowable value for the <i>Data Type</i> See "7.3. Semantics."
11	Optional (Not Supported)	Get	NV	Offset-A Data Type	USINT (byte)	Determines the Data Type of attribute <i>Offset-A</i>	See "7.3. Semantics." [default] = INT
12	Optional (Not Supported)	Set	NV	Offset-A	INT or specified by <i>Offset-A Data Type</i> if supported	An amount added prior to <i>Gain</i> to derive <i>Value</i>	See "7.3. Semantics." 0 = [default]
13	Required if Attribute "Gain" is other than REAL (Not Supported)	Get	NV	Gain Data Type	USINT (byte)	Determines the Data Type of attribute <i>Gain</i>	See "7.3. Semantics." [default] = REAL
14	Optional (Not Supported)	Set	NV	Gain	REAL or specified by <i>Gain Data Type</i> if supported	An amount scaled to derive <i>Value</i>	See "7.3. Semantics." 1.0 = [default]
15	Required if Attribute "Gain" is other than REAL (Not Supported)	Get	NV	Unity Gain Reference	REAL or specified by <i>Gain Data Type</i> if supported	Specifies the value of the <i>Gain</i> attribute equivalent to a gain of 1.0	Used for normalizing the <i>Gain</i> attribute. [default] = 1.0 e.g., for an UINT type <i>Gain</i> , a Unity Gain Reference may be 10000, allowing a gain of 0.0001 to 6.5535.
16	Optional (Not Supported)	Set	NV	Offset-B	INT or specified by <i>Data Type</i> if supported	An amount added to derive <i>Value</i>	See "7.3. Semantics." 0 = [default]

Brooks DeviceNet PCs/PMs

Attr ID	Need in Implementation	Access Rule	NV*	Name	DeviceNet Data Type	Description of Attribute	Semantics of Values
17	Optional (Not Supported)	Set	NV	Alarm Trip Point High	INT or specified by <i>Data Type</i> if supported	Determines the Value above which an Alarm Condition will occur	See "7.3. Semantics." [default] = Maximum value for its data type.
18	Optional (Not Supported)	Set	NV	Alarm Trip Point Low	INT or specified by <i>Data Type</i> if supported	Determines the Value below which an Alarm Condition will occur	See "7.3. Semantics." [default] = Minimum value for its data type.
19	Optional (Not Supported)	Set	NV	Alarm Hysteresis	INT or specified by <i>Data Type</i> if supported	Determines the amount by which the <i>Value</i> must recover to clear an Alarm Condition	See "7.3. Semantics." [default] = 0
20	Optional (Not Supported)	Set	NV	Alarm Settling Time	UINT	Determines the time that the <i>Value</i> must exceed the Trip Point before the exception condition is generated.	Time in milliseconds See "7.3. Semantics." [default] = 0
21	Optional (Not Supported)	Set	NV	Warning Trip Point High	INT or specified by <i>Data Type</i> if supported	Determines the <i>Value</i> above which a Warning Condition will occur	See "7.3. Semantics." [default] = Maximum value for its data type.
22	Optional (Not Supported)	Set	NV	Warning Trip Point Low	INT or specified by <i>Data Type</i> if supported	Determines the <i>Value</i> below which a Warning Condition will occur	See "7.3. Semantics." [default] = Minimum value for its data type.
23	Optional (Not Supported)	Set	NV	Warning Hysteresis	INT or specified by <i>Data Type</i> if supported	Determines the amount by which the <i>Value</i> must recover to clear a Warning Condition	See "7.3. Semantics." [default] = 0

Attr ID	Need in Implementation	Access Rule	NV*	Name	DeviceNet Data Type	Description of Attribute	Semantics of Values
24	Optional (Not Supported)	Set	NV	Warning Settling Time	UINT	Determines the time that the <i>Value</i> must exceed the Trip Point before the exception condition is generated.	Time in milliseconds See "7.3. Semantics." [default] = 0
25	Optional (Not Supported)	Set	NV	Safe State	USINT (byte)	Specifies the behavior for the <i>Value</i> for states other than Execute	See "7.3. Semantics." [default] = 0
26	Optional (Not Supported)	Set	NV	Safe Value	INT or specified by <i>Data Type</i> if supported	The <i>Value</i> to be used for Safe State = Safe Value	See "7.3. Semantics." [default] = 0
27	Optional (Not Supported)	Set	NV	Autozero Enable	BOOL	Enables the Autozero	See "7.3. Semantics." 0 = disable [default] 1 = enable
28	Optional (Supported)	Get	V	Autozero Status	BOOL	Indicates the status of the automatic nulling	See "7.3. Semantics." [default] = 0
29	Optional (Not Supported)	Set	NV	Autorange Enable	BOOL	Enables the automatic range switching	See "7.3. Semantics." 0 = disable [default] 1 = enable
30	Optional (Not Supported)	Get	V	Range Multiplier	REAL	Indicates the current range multiplier	See "7.3. Semantics." [default] = 1.0
31	Optional (Not Supported)	Set	NV	Averaging Time	UINT	Specifies the time over which analog samples are averaged.	Time in Milliseconds of a moving-window average. 0 = disable averaging [default] Values less than the sample rate of the device also disable averaging.

Brooks DeviceNet PCs/PMs

Attr ID	Need in Implementation	Access Rule	NV*	Name	DeviceNet Data Type	Description of Attribute	Semantics of Values
32	Optional (Not Supported)	Get	NV	Overrange	INT or specified by <i>Data Type</i> if supported	Specifies the highest valid <i>Value</i>	The value above which attribute <i>Reading Valid</i> is set to invalid. [default] = maximum allowable value for the <i>Data Type</i>
33	Optional (Not Supported)	Get	NV	Underrange	INT or specified by <i>Data Type</i> if supported	Specifies the lowest valid <i>Value</i>	The value below which attribute <i>Reading Valid</i> is set to invalid. [default] = minimum allowable value for the <i>Data Type</i>
34	Optional (Not Supported)	Set	NV	Produce Trigger Delta	INT or specified by <i>Data Type</i> if supported	The amount by which <i>Value</i> must change before a Change of State Production is triggered	0 = Disabled [default] See "7.3. Semantics."
35	Conditional ² (Supported)	Set	NV	Gas Calibration Object Instance	UINT	Indicates which Gas Calibration object instance is active for this object	0 = Disabled [default] See "7.3. Semantics."
97-98	Reserved by DeviceNet						
99	Conditional ³ (Supported)	Get	NV	Subclass	UINT	Identifies a subset of additional attributes, services and behaviors. The subclasses for this object are specified at the end of this object specification section.	0 = No subclass n = subclass as defined herein
110	Optional (Supported)	Get	NV	Full Scale	Struct: real, uint	Full scale amount (real) and data units (uint)	Default = 0, 0.

¹ *Data Type* and *Data Units* are ONLY settable under certain conditions (see "7.3. Semantics").

² Attribute is settable; however, it should only be set while in the Idle state (see "7.3. Semantics").

³ If the value of Subclass is 00, then this attribute is OPTIONAL in implementation, otherwise, this attribute is REQUIRED.

7.3. Semantics

Data Type

All Data Type attributes, including *Data Type*, *Offset-A Data Type* and *Gain Data Type*, use the enumerated values specified in DeviceNet Vol. I, Appendix J-6.1.

The *Data Type* attribute is settable only in the *Idle State* and only if no attribute belonging to the object instance is the endpoint of an I/O connection in the *Established State*.

The *Data Type* attribute may change automatically based upon established I/O connections. See “7.6. Behavior” for more information on this mechanism.

Data Units

Specifies the context of *Value* and related attributes (such as, offset and trip points) for this object instance. See Appendix K for a list of values. A request to set attribute to an unsupported value will return an error response.

The *Data Units* attribute is settable only in the *Idle State*.

Value, Offset (A and B) and Gain

An S-Analog Sensor object instance derives a reading from a physical analog sensor. The reading is converted to the data type and units specified for the *Value* attribute. The *Offset-A*, *Offset-B* and *Gain* attributes are applied to the sensor reading as specified by the following formula:

$$\text{Value} = \text{Gain} \bullet (\text{Sensor Reading} + \text{Offset-A}) + \text{Offset-B}$$

Typically, the *Offset-A* or *Offset-B* attributes are modified by the Zero-Adjust service and the *Gain* attribute is modified by the Gain_Adjust services; particularly, when the device utilizes a non-linear conversion algorithm. However, support of these services is not required.

See “7.6. Behavior”.

Status

A bit mapped byte, which indicates the Alarm and Warning Exception status of the object instance. The following definition applies:

Bit	Definition
0	High Alarm Exception: 0 = cleared; 1 = set
1	Low Alarm Exception: 0 = cleared; 1 = set
2	High Warning Exception: 0 = cleared; 1 = set
3	Low Warning Exception: 0 = cleared; 1 = set
4	Reserved
5	Reserved
6	Reserved
7	Reserved

Trip Points, Hysteresis and Settling Time

Trip Point High is the level above which the *Value* attribute will cause an Alarm or Warning exception condition.

Trip Point Low is the level below which the *Value* attribute will cause an Alarm or Warning exception condition.

A Hysteresis value specifies the amount by which the *Value* attribute must transition in order to clear an Alarm or Warning condition. For example: A Trip Point High value of 100 and a hysteresis value of 2 will result in an exception condition being set when the *Value* is above 100 and cleared when the *Value* drops below 98. Similarly, A Trip Point Low value of 100 and a hysteresis value of 2 will result in an exception condition being set when the *Value* is below 100 and cleared when the *Value* increases above 102.

The Settling Time determines the amount of time that the *Value* attribute must exceed the Trip Point before the exception condition is generated. The Settling Time also applies to the clearing of the condition.

Safe State

This attribute specifies what value will be held in *Value* for states other than Executing. See the S-Device Supervisor object definition in Section 6 for a description of object states. The purpose of this mechanism is to allow other devices, that may be using this *Value*, to transition to, or remain in, a safe state in the event of this device transitioning to a FAULT, IDLE, or ABORT state. The following values are defined:

Attribute Value	State
0	Zero
1	Full Scale
2	Hold Last Value
3	Use Safe Value
4-50	Reserved
51-99	Device Specific
100-255	Vendor Specific

Safe Value

For Safe State set to Use Safe Value, this attribute holds the value to which the *Value* attribute will be set for object instance states other than Executing.

Autozero Enable and Autozero Status

When the autozero is enabled, the device will automatically invoke a Zero_Adjust service request (no parameter) contingent upon a set of conditions specified by the manufacturer. These conditions may be determined by the value of an attribute (e.g., setpoint) or some other mechanism defined by the manufacturer. See Zero_Adjust service.

The GF100 Series uses the Autozero Status attribute to convey the status of the Zero-Adjust Service operation. If the device receives an explicit message from the host to perform a Zero-Adjust Service, the GF100 Series will perform the service and set the Autozero Status to 1 for the duration of the service. After the Zero-Adjust service has completed, the Autozero Status will be set to zero. The MFC Device Profile appears to indicate that the Autozero Status attribute is only to be used for an internally triggered Zero-Adjust Service; however, the GF100 Series uses the Autozero Status to convey the status of the Zero-Adjust Service, no matter how the service was triggered.

Autorange Enable and Range Multiplier

When the autorange is enabled, the device will automatically switch full scale range based on a set of conditions specified by the manufacturer. The Range Multiplier indicates the range scale.

An example of how Autorange may work is: when the *Value* is less than 9% with a *Range Multiplier* of 1.0, the *Range Multiplier* switches to 10.0 (the *Value* then reads 90% of the 10X range). When the *Value* then reaches 100% with a *Range Multiplier* of 10.0, the *Range Multiplier* returns to 1.0 (the *Value* then reads 10% of the 1X range).

Produce Trigger Delta

This attribute is used in conjunction with the "Change of State" production trigger type. Upon transition of the associated connection object instance (any Change of State connection pointing to the S-Analog Sensor object *Value* attribute) to the established state, a production is immediately triggered and this reported *Value* is stored internally for the determination of the next production trigger. When the *Value* changes by an amount of at least the *Produce Trigger Delta* (i.e., the *Value* as compared to the internally stored previously produced *Value*), a new production is triggered, and this reported *Value* becomes the new internally stored *Value* for the determination of the next production trigger.

Gas Calibration Object Instance

This attribute is used to select an instance of the S-Gas Calibration object. The selected S-Gas Calibration object instance provides the data with which an S-Analog Sensor object instance enacts the appropriate calibration algorithm for a given gas type.

A Set_Attribute_Single request, specifying a value not supported, will return an "invalid attribute value" error response. A list of acceptable values for this attribute is derived from a class level service request to the S-Gas Calibration object.

Conditionally Required: If a device profile specifies an S-Gas Calibration object relationship for an S-Analog Sensor object instance, then this attribute is required.

See the S-Gas Calibration object definition for more information.

Caution: Care should be taken when changing the gas instance. The MFC profile allows the user to change the gas instance at any time; however, the attribute should only be changed when the device is Idle. Unpredictable results may occur if the gas instance is changed while the MFC is in the Execute State.

7.4. S-Analog Sensor Common Services

The S-Analog Sensor Object provides the following Common Services:

Service Code	Need in Implementation		Service Name	Description of Service
	Class	Instance		
0Ehex 14dec	Conditional *	Required	Get_Attribute_Single	Returns the contents of the specified attribute.
10hex 16dec	n/a	Required	Set_Attribute_Single	Modifies an attribute value.
*The Get_Attribute_Single service is REQUIRED if any attributes are implemented.				

See the DeviceNet Communication Model and Protocol for definitions of these common services.

7.5. S-Analog Sensor Object-Specific Services

Service Code	Need in Implementation		Service Name	Description of Service
	Class	Instance		
4Bhex 75dec	N/a	Optional (Supported)	Zero_Adjust	Causes the device to modify attribute <i>Offset-A</i> and/or <i>Offset-B</i> such that attribute <i>Value</i> equals the Target Value sent with the request.
4Chex 76dec	N/a	Optional (Not Supported)	Gain_Adjust	Causes the device to modify attribute <i>Gain</i> , such that attribute <i>Value</i> , equals the Target Value sent with the request.

The Zero_Adjust and Gain_Adjust services are used to cause the S-Analog Sensor Object device to modify its *Offset-A* and/or *Offset-B* and *Gain* attribute values based upon manufacturer specific algorithms. The target value specified in the service request represents the actual parametric measurement that the physical sensor should be reporting at the time of the request.

Brooks DeviceNet PCs/PMs

There are no state transitions associated with the invocation of these services. It is, therefore, incumbent upon the user to establish the device into the desired configuration prior to, and during, the execution of these services. This will generally involve exposing the sensor to a known environment and treating the values read during execution of the services accordingly.

A success service response indicates that the service was accepted and the application process started.

7.5.1. Zero_Adjust Request Service Data Field Parameters

Parameter	Required	Data Type	Description	Semantics of Values
Target Value	Optional (Supported)	Specified by the value of attribute <i>Data Type</i>	The target value for the zero calibration	The value to which the <i>Value</i> attribute will be set. If not specified, the default value of zero is used.

7.5.2. Gain_Adjust Request Service Data Field Parameters

Parameter	Required	Data Type	Description	Semantics of Values
Target Value	Required	Specified by the value of attribute <i>Data Type</i>	The target value for the gain calibration	The value to which the <i>Value</i> attribute will be set.

Note: Support of the Zero Adjust Service - target Value must be zero. To invoke Zero Adjust, the user should put the MFC in a steady-state condition with zero flow, prior to sending the Service.

ADD DETAILS FOR PRESSURE ZERO!

If Data Type is Integer:

ServiceCode=4BH, Class=31H, Instance=1, Data or Target Value = (00 00).

If Data Type is Real:

ServiceCode=4BH, Class=31H, Instance=1, Data or Target Value = (00 00 00 00).

7.6. Behavior

The S-Device Supervisor Object manages the behavior of the S-Analog Sensor Object. See Section 6 of this document.

An S-Analog Sensor object instance acquires a reading from a physical sensor, as identified by the application of the object, and applies an algorithm to modify the reading into the appropriate *Data Type* and *Data Units*. Optionally, additional corrective algorithms are applied to further correct for various calibration effects. These additional algorithms are specified in other objects, as identified in the device profile, or as extensions, specified by the manufacturer.

All Full Scale, Trip Point, Overrange and Underrange calculations, as specified above, utilize the *Value* attribute.

Data Type

If the implementation of this object specifies more than one valid Data Type value, in the device profile or by vendor, then the following behavior with respect to *Data Type* applies: The Data Type value will be set automatically based upon the first valid I/O connection established by the device. This configuration will then remain in effect for this object instance, even after all I/O connections are lost. For devices that support only one Data Type, this behavior is not supported.

If no established I/O connections exist, which include an attribute from this object, then the *Data Type* attribute is settable provided that the object is in the *Idle State*.

The following example demonstrates this behavior:

A device profile specifies an instance of the S-Analog Sensor object as well as two static Assembly object instances, both with data attribute components mapped to this object instance. Assembly object instance ID 1 specifies INT data types and Assembly object instance ID 2 specifies REAL data types.

After the device is On-Line, it is configured with an I/O connection to Assembly instance ID 2. When the connection transitions to the *Established State*, this object instance attribute *Data Type* is automatically set with the value for REAL before any data is communicated to, or from, the object instance.

GF100 Series Implementation

Data Type values supported are Integer (0xC3) and Real (0xCA). Data Units supported are Counts (0x1001) and SCCM (0x1400). Both Data Type and Data Units attributes are settable. The supported combinations of Data Type and Data Units on IntelliFlow™ are Integer-Counts (default), Real-SCCM, Integer-SCCM, and Real-Counts. The full-scale range for indicated flow is determined by the full-scale attribute (31H, 1,10).

7.7. S-Analog Sensor Object Instance Subclass 01

The following specification applies to a subclass of this object for application in Mass Flow Controller devices.

7.7.1. Subclass 01 Instance Attributes

The following Instance Attributes are specified for this object subclass.

Attr ID	Need in Implementation	Access Rule	NV*	Name	DeviceNet Data Type	Description of Attribute	Semantics of Values
95	Optional (Supported)	Get	NV	Flow Totalizer	ULINT	Total gas flowed through the device since this value was last set to zero	Units are Standard CCs. See "7.7.3. Subclass 01 Behavior." Default = 0.
96	Optional (Not Supported)	Set	NV	Flow Hours	UDINT	Total time device has been powered and flowing gas since this value was last set to zero	Resolution is one hour. See "7.7.3. Subclass 01 Behavior." Default = 0.

* NV = Nonvolatile; attribute value is maintained through power cycles; V = Volatile

7.7.2. Subclass 01 Services

There are no additions or restrictions to the Object Services for this object subclass.

7.7.3. Subclass 01 Behavior

Flow Totalizer and Flow Hours Process

The factory configured out-of-box values for the Flow Totalizer and Flow Hours attributes are both zero. The attributes are only modifiable with *set_attribute_single* service requests; they are not altered by the *Reset* service, including power-cycle, of either the Identity or the S-Device Supervisor objects.

The Flow Totalizer attribute is incremented, at a rate of once every cubic centimeter of gas flow, by the S-Analog Sensor object instance to reflect the amount of gas that has flowed through the device. Upon reaching its maximum value, the Flow Totalizer value is no longer incremented and remains at its maximum value.

The Flow Hours attribute is incremented, at a rate of once every hour, by the S-Analog Sensor object instance to reflect the amount of time that gas has flowed through the device. This condition is determined by the *Value* attribute being greater than 0.5% of full scale. Upon reaching its maximum value, the Flow Hours value is no longer incremented and remains at its maximum value.

*THIS PAGE WAS
INTENTIONALLY
LEFT BLANK*

8. S-Analog Actuator Object (Class 0x32)

The S-Analog Actuator Object models the interface to a physical actuator in a device. Associated with an analog actuator is a value, which is corrected with an offset and a gain coefficient, optionally settable in the object before it is output to the physical actuator. Manufacturers may specify additional correction algorithms as extensions to this object.

Additionally, the S-Analog Actuator Object provides two sets of trip-point definitions. The behavior associated with these trip points is described in sections below.

This object is a member of the *Hierarchy of Semiconductor Equipment Devices*. The S-Device Supervisor manages the behavior of the S-Analog Actuator Object. See Section 6 of this document.

8.1. S-Analog Actuator Class Attributes

The Object Class Attribute ID 1-7 are reserved. See DeviceNet Volume II, Section 5-4.1. for more specification detail on these attributes.

Attribute ID	Need in implementation	Access Rule	Name	DeviceNet Data Type	Description of Attribute
1 thru 7	These class attributes are either optional or conditional and are described in chapter 5 of this specification.				
97 & 98	Reserved by DeviceNet				
99	Conditional * (Supported)	Get	Subclass	UINT	Identifies a subset of additional attributes, services and behaviors. The subclasses for this object are specified at the end of this object specification section.

** If the value of Subclass is 00, which identifies "no subclass", then this attribute is OPTIONAL in implementation, otherwise, this attribute is REQUIRED.*

Brooks DeviceNet PCs/PMs

8.2. S-Analog Actuator Instance Attributes

Certain minimal implementations may support any optional “Set” attributes as “Get” only and still be compliant with this object specification. All required attributes must be supported as specified.

Attr ID	Need in Implementation	Access Rule	NV*	Name	DeviceNet Data Type	Description of Attribute	Semantics of Values
1	Optional (Not Supported)	Get	NV	Number of Attributes	USINT (byte)	Number of supported attributes	The number of attributes supported by this object instance
2	Optional (Not Supported)	Get	NV	Attribute List	ARRAY OF USINT (byte)	List of supported attribute	List of attributes supported by this object instance
3	Optional (Supported)	See “8.3. Semantics” Set ¹	NV	Data Type	USINT (byte)	Determines the Data Type of <i>Value</i> and all related attributes as specified in this table.	See “8.3. Semantics.” [default] = INT INT or Real supported
4	Optional (Supported)	See “8.3. Semantics” Set ¹	NV	Data Units	UINT	Determines the context of <i>Value</i>	See “8.3. Semantics.” [default] = Counts Counts or Percent supported
5	Required	Set	V	Override	USINT (byte)	Specifies an override for the physical actuator. For values other than zero (normal control), the <i>Value</i> attribute is ignored.	0 = normal [default] See “8.3. Semantics.” ⁿ
6	Required	Set	V	Value	INT or specified by <i>Data Type</i> if supported	Analog output value	The uncorrected value. see Semantics section [default] = 0
7	Required	Get	V	Status	BYTE	Alarm and Warning State of this object instance	See “8.3. Semantics.” [default] = 0
8	Optional (Supported)	Set	NV	Alarm Enable	BOOL	Enables the setting of the Alarm Bit	0 = disable [default] 1 = enable
9	Optional (Supported)	Set	NV	Warning Enable	BOOL	Enables the setting of the Warning Bit	0 = disable [default] 1 = enable

Attr ID	Need in Implementation	Access Rule	NV*	Name	DeviceNet Data Type	Description of Attribute	Semantics of Values
10	Optional (Not Supported)	Set	NV	Offset	INT or specified by <i>Data Type</i> if supported	An amount to be added to <i>Value</i> prior to the application of gain	See "8.3. Semantics." 0 = [default]
11	Optional (Not Supported)	Set	NV	Bias	INT or specified by <i>Data Type</i> if supported	An amount to be added to <i>Value</i> prior to the application of gain	See "8.3. Semantics." 0 = [default]
12	Required if Attribute "Gain" is other than REAL (Not Supported)	Get	NV	Gain Data Type	USINT (byte)	Determines the Data Type of attribute <i>Gain</i>	See "8.3. Semantics." [default] = REAL
13	Optional (Not Supported)	Set	NV	Gain	REAL or specified by <i>Gain Data Type</i> if supported	An amount by which <i>Value</i> is scaled prior to driving the physical actuator	See "8.3. Semantics." 1.0 = [default]
14	Required if Attribute 12 is other than REAL (Not Supported)	Get	NV	Unity Gain Reference	REAL or specified by <i>Gain Data Type</i> if supported	Specifies the value of the <i>Gain</i> attribute equivalent to a gain of 1.0	Used for normalizing the <i>Gain</i> attribute. See "8.3. Semantics." [default] = 1.0
15	Optional (Not Supported)	Set	NV	Alarm Trip Point High	INT or specified by <i>Data Type</i> if supported	Determines the Value above which an Alarm Condition will occur	See "8.3. Semantics." [default] = Maximum value for its data type.
16	Optional (Not Supported)	Set	NV	Alarm Trip Point Low	INT or specified by <i>Data Type</i> if supported	Determines the Value below which an Alarm Condition will occur	See "8.3. Semantics." [default] = Minimum value for its data type.
17	Optional (Not Supported)	Set	NV	Alarm Hysteresis	INT or specified by <i>Data Type</i> if supported	Determines the amount by which the Value must recover to clear an Alarm Condition	See "8.3. Semantics." [default] = 0
18	Optional (Not Supported)	Set	NV	Warning Trip Point High	INT or specified by <i>Data Type</i> if supported	Determines the Value above which a Warning Condition will occur	See "8.3. Semantics." [default] = Maximum value for its data type.

Brooks DeviceNet PCs/PMs

Attr ID	Need in Implementation	Access Rule	NV*	Name	DeviceNet Data Type	Description of Attribute	Semantics of Values
19	Optional (Not Supported)	Set	NV	Warning Trip Point Low	INT or specified by <i>Data Type</i> if supported	Determines the Value below which a Warning Condition will occur	See "8.3. Semantics." [default] = Minimum value for its data type.
20	Optional (Not Supported)	Set	NV	Warning Hysteresis	INT or specified by <i>Data Type</i> if supported	Determines the amount by which the Value must recover to clear a Warning Condition	See "8.3. Semantics." [default] = 0
21	Optional (Supported)	Set	NV	Safe State	USINT (byte)	Specifies the behavior of the physical actuator for states other than Execute	See "8.3. Semantics." 0 = [default]
22	Optional (Not Supported)	Set	NV	Safe Value	INT or specified by <i>Data Type</i> if supported	The Value to be used for Safe State = Safe Value	See "8.3. Semantics." 0 = [default]
97-98	Reserved by DeviceNet						
99	Conditional ² (Supported)	Get	NV	Subclass	UINT	Identifies a subset of additional attributes, services and behaviors. The subclasses for this object are specified at the end of this object specification section.	0 = No subclass n = subclass as defined herein

NV = Nonvolatile; value is maintained through power cycle. V = Volatile

¹ Data Type and Data Units Attribute are settable ONLY under certain conditions (see "8.3. Semantics.")

² If the value of Subclass is 00, then this attribute is OPTIONAL in implementation, otherwise, this attribute is REQUIRED.

8.3. Semantics

Data Type

All Data Type attributes, including *Data Type* and *Gain Data Type*, use the enumerated values specified in DeviceNet Vol. I, Appendix J-6.1.

The *Data Type* attribute is settable only in the *Idle State* and only if no attribute belonging to the object instance is the endpoint of an I/O connection in the *Established State*.

The *Data Type* attribute may change automatically based upon established I/O connections. See “8.6. S-Analog Actuator Behavior” for more information on this mechanism.

Data Units

Specifies the context of *Value* and related attributes (such as, offset and trip points) for this object instance. See Appendix K for a list of values. A request to set attribute to an unsupported value will return an error response.

The *Data Units* attribute is settable only in the *Idle State*.

Value, Offset, Gain, Bias and Unity Gain Reference

The *Offset*, *Gain* and *Bias* attributes are applied to the *Value* attribute to derive the actual signal, which drives the physical actuator. The gain is normalized using the *Unity Gain Reference* attribute value. (e.g., for an UINT type *Gain*, a *Unity Gain Reference* value may be 10000, allowing an effective gain of 0.0001 to 6.5535.)

The following formula applies:

$$\text{physical actuator drive signal} = \text{Gain}_N \bullet (\text{Value} + \text{Offset}) + \text{Bias}$$

where:

$$\text{Gain}_N = \text{Gain}/\text{Unity Gain Reference}$$

There may be additional nonlinear conversions applied to the drive signal as specified by the manufacturer.

Status

A bit mapped byte, which indicates the Alarm and Warning Exception status of the object instance. The following definition applies:

Bit	Definition
0	High Alarm Exception: 0 = cleared; 1 = set
1	Low Alarm Exception: 0 = cleared; 1 = set
2	High Warning Exception: 0 = cleared; 1 = set
3	Low Warning Exception: 0 = cleared; 1 = set
4	Reserved
5	Reserved
6	Reserved
7	Reserved

Trip Points and Hysteresis

Trip Point High is the level above which the *Value* attribute will cause an Alarm or Warning exception condition.

Trip Point Low is the level below which the *Value* attribute will cause an Alarm or Warning exception condition.

A *Hysteresis* value specifies the amount by which the *Value* attribute must transition in order to clear an Alarm or Warning condition.

For example: A *Trip Point High* value of 90 and a *Hysteresis* value of 2 will result in an exception condition being set when the *Value* is above 90 and cleared when the *Value* drops below 88. Similarly, A *Trip Point Low* value of 90 and a *Hysteresis* value of 2 will result in an exception condition being set when the *Value* is below 90 and cleared when the *Value* increases above 92.

Override

This attribute is used to override the function of the *Value* attribute in driving the physical actuator. The primary application of this feature is in devices where the object instance is being driven by another object such as an S-Single Stage Controller object instance.

The *Safe State* attribute provides a mechanism for override depending upon object state and will take precedents over this. That is, if an object instance implements the *Safe State* attribute and related behavior, then this *Override* attribute and related behavior will only function in the Executing State.

Attribute Value	State
0	Normal (Supported)
1	Off/Closed (Supported)
2	On/Open (Supported)
3	Hold
4	Safe State
5-63	Reserved
64-127	Device Specific
128-255	Vendor Specific

Safe State

This attribute specifies the behavior of the drive to the physical actuator for states other than Executing. See the S-Device Supervisor object definition in Section 6-48 for a description of object states. The following values are defined:

Attribute Value	State
0	Zero/Off/Closed
1	Full Scale/On/Open
2	Hold Last Value
3	Use Safe Value
4-63	Reserved
64-127	Device Specific
128-255	Vendor Specific

IntelliFlow supports the Safe State Attribute as a Get Only attribute that returns a value of zero or “closed”.

Safe Value

For *Safe State* set to “Use Safe Value”, this attribute holds the value to which the actuator will be driven for object instance states other than Executing. Specifically, this attribute value will become the value of the *Value* attribute. Therefore, the correction formula specified above applies.

8.4. S-Analog Actuator Common Services

The S-Analog Actuator Object provides the following Common Services:

Service Code	Need in Implementation		Service Name	Description of Service
	Class	Instance		
0Ehex 14dec	Conditional*	Required	Get_Attribute_Single	Returns the contents of the specified attribute.
10hex 16dec	n/a	Required	Set_Attribute_Single	Modifies an attribute value.
*The Get_Attribute_Single service is REQUIRED if any attributes are implemented.				

See the DeviceNet Communication Model and Protocol for definitions of these common services.

8.5. S-Analog Actuator Object–Specific Services

The S-Analog Actuator Object provides no Object–Specific services.

8.6. S-Analog Actuator Behavior

The S-Device Supervisor Object manages the behavior of the S-Analog Actuator Object. See Section 6.

An S-Analog Actuator object instance modifies the *Value* by applying the formula specified above with the associated attribute values. *Value* is specified as *Data Type* and *Data Units*. Optionally, additional corrective algorithms are applied to further correct for various calibration effects. These additional algorithms are specified in other objects, as identified in the device profile, or as extensions, specified by the manufacturer.

All Trip Point calculations, as specified above, utilize the *Value* attribute before the application of *Offset* and *Gain*.

Data Type

If the implementation of this object specifies more than one valid Data Type value, in the device profile or by vendor, then the following behavior with respect to *Data Type* applies. The Data Type value will be set automatically based upon the first valid I/O connection established by the device. This configuration will then remain in effect for this object instance, even after all I/O connections are lost. For devices that support only one Data Type, this behavior is not supported.

If no established I/O connections exist, which include an attribute from this object, then the *Data Type* attribute is settable provided that the object is in the *Idle State*.

The following example demonstrates this behavior:

A device profile specifies an instance of the S-Analog Actuator object as well as two static Assembly object instances, both with data attribute components mapped to this object instance. Assembly object instance ID 1 specifies INT data types and Assembly object instance ID 2 specifies REAL data types.

After the device is On-Line, it is configured with an I/O connection to Assembly instance ID 2. When the connection transitions to the *Established State*, this object instance attribute *Data Type* is automatically set with the value for REAL before any data is communicated to, or from, the object instance.

GF100 Series Implementation

Data Type values supported are Integer (0xC3) and Real (0xCA). Data Units supported are Counts (0x1001) and Percent (0x1007). Data Type and Data Units attributes are settable. The supported combinations of Data Type and Data Units on Intelliflow™ are Integer-Counts (default), Real-Percent, Integer-Percent, and Real-Counts. The Real-Percent values range from 0.0 to 100.0, where the value represents percent of full-scale that the actuator is being driven. Integer-Percent value range is 0 to 100 integer. Integer-Counts value range is 0 to 0x7FFF. Typical count range is 0 to 24576, (0x6000).

*THIS PAGE WAS
INTENTIONALLY
LEFT BLANK*

9. S-Single Stage Controller Object (Class 0x33)

The S-Single Stage Controller Object models a closed-loop control system within a device. Associated with a single stage controller is a Process Variable, a Setpoint and a Control Variable. As normally described by *classic control theory*, a closed-loop controller will drive the Control Variable in order to affect the value of the Process Variable such that it is made to equal the Setpoint. See the Semantics section, below, for more information regarding these variable definitions. Manufacturers may specify additional correction algorithms as extensions to this object.

This object is a member of the *Hierarchy of Semiconductor Equipment Devices*. The S-Device Supervisor Object manages the behavior of the S-Single Stage Controller Object. See Section 6.

9.1. S-Single Stage Controller Class Attributes

The Object Class Attribute ID 1-7 are reserved. See DeviceNet Volume II, Section 5-4.1. for more specification detail on these attributes.

Attribute ID	Need in implementation	Access Rule	Name	DeviceNet Data Type	Description of Attribute
1 thru 7	These class attributes are either optional or conditional and are described in chapter 5 of this specification.				
97 & 98	Reserved by DeviceNet				
99	Conditional * (Supported)	Get	Subclass	UINT	Identifies a subset of additional attributes, services and behaviors. The subclasses for this object are specified at the end of this object specification section.

** If the value of Subclass is 00, which identifies "no subclass", then this attribute is OPTIONAL in implementation, otherwise, this attribute is REQUIRED.*

9.2. S-Single Stage Controller Instance Attributes

Certain minimal implementations may support any optional “Set” attributes as “Get” only and still be compliant with this object specification. All required attributes must be supported as specified.

Attr ID	Need in Implementation	Access Rule	NV*	Name	DeviceNet Data Type	Description of Attribute	Semantics of Values
1	Optional (Not Supported)	Get	NV	Number of Attributes	USINT (byte)	Number of supported attributes	Number of attributes supported in this object instance
2	Optional (Not Supported)	Get	NV	Attribute List	ARRAY OF USINT (byte)	Attribute List	List of attributes supported in this object instance
3	Optional (Supported)	See “9.3. Semantics.” Set ²	NV	Data Type	USINT (byte)	Determines the Data Type of <i>Setpoint</i> , <i>Process Variable</i> and related attributes	See “9.3. Semantics.” [default] = INT INT and Real supported
4	Optional (Supported)	See “9.3. Semantics” Set ²	NV	Data Units	UINT	Determines the context of the Process related variables such as Setpoint and Process Variable	See Appendix K. [default] = Counts Counts and SCCM supported
5	Optional (Not Supported)	Set	NV	Control Mode	USINT (byte)	Specifies the operational mode of the controller	See “9.3. Semantics.” [default] = Normal (0)
6	Required	Set	V	Setpoint	INT or specified by <i>Data Type</i> if supported	The setpoint to which the process variable will be controlled	See “9.3. Semantics.” See “9.6. Behavior.” 0 = [default] Range is one of: 0-6000H (0 – 100%) 0-7FFFH (0-100%)
7	Conditional ² (Not Supported)	Set	V	Process Variable	INT or specified by <i>Data Type</i> if supported	The measured process parameter	The device profile must specify the data connection for this attribute. It may be internally linked to a sensor. See Semantics section. 0 = [default]

Attr ID	Need in Implementation	Access Rule	NV*	Name	DeviceNet Data Type	Description of Attribute	Semantics of Values
8	Optional (Not Supported)	Get	NV	CV Data Type	USINT (byte)	Determines the Data Type of <i>Control Variable</i>	See "9.3. Semantics." [default] = INT
9	Conditional ** (Not Supported?)	Get	V	Control Variable	INT or specified by <i>CV Data Type</i> if supported	The drive signal output of this object. The algorithm by which this attribute is calculated is manufacturer specific.	The device profile must specify the data connection for this attribute. It may be internally linked to an actuator. [default] = 0 See "9.3. Semantics."
10	Required	Get	V	Status	BYTE	Alarm and Warning State of this object instance	See "9.3. Semantics." [default] = 0
11	Optional (Supported)	Set	NV	Alarm Enable	BOOL	Enables the setting of the Alarm Status Bit	0 = disable [default] 1 = enable
12	Optional (Supported)	Set	NV	Warning Enable	BOOL	Enables the setting of the Warning Status Bit	0 = disable [default] 1 = enable
13	Optional (Not Supported)	Set	NV	Alarm Settling Time	UINT	Number of Milliseconds allowed for the control-loop to settle to within the error band	See "9.6. Behavior." [default] = 0
14	Optional (Not Supported)	Set	NV	Alarm Error Band	INT or specified by <i>Data Type</i> if supported	The amount by which the <i>Setpoint</i> must equal the <i>Process Variable</i>	See "9.6. Behavior." [default] = 0
15	Optional (Not Supported)	Set	NV	Warning Settling Time	UINT	Number of Milliseconds allowed for the control-loop to settle to within the Error Band	See "9.6. Behavior." [default] = 0
16	Optional (Not Supported)	Set	NV	Warning Error Band	INT or specified by <i>Data Type</i> if supported	The amount by which the <i>Setpoint</i> must equal the <i>Process Variable</i>	See "9.6. Behavior." [default] = 0

Brooks DeviceNet PCs/PMs

Attr ID	Need in Implementation	Access Rule	NV*	Name	DeviceNet Data Type	Description of Attribute	Semantics of Values
17	Optional (Not Supported)	Set	NV	Safe State	USINT (byte)	Specifies the Control Variable behavior for states other than Execute	See "9.3. Semantics." 0 = [default]
18	Optional (Not Supported)	Set	NV	Safe Value	INT or specified by <i>Data Type</i> if supported	The value to be used for Safe State = Safe Value	See "9.3. Semantics." 0 = [default]
19	Optional (Supported)	Set	NV	Ramp Rate	UDINT (4-bytes)	Time in Milliseconds to reach Setpoint	0 = Disabled [default] x = value in milliseconds Where: 0 < x < 7FFF DeviceNet specifies 4 bytes of data, but only 2 are used. See "9.6. Behavior."
97-98	Reserved by DeviceNet						
99	Conditional ³ (Supported)	Get	NV	Subclass	UINT	Identifies a subset of additional attributes, services and behaviors. The subclasses for this object are specified at the end of this object specification section.	0 = No subclass n = subclass as defined herein

NV = Nonvolatile; value is retained through power cycle.

¹ Data Type is settable ONLY under certain conditions (see semantics)

² The Process Variable is only optional if this device includes an internal sensor. Otherwise, the Process Variable is required. Similarly, The Control Variable is only optional if this device includes an internal actuator. Otherwise, the Control Variable is required.

³ If the value of Subclass is 00, then this attribute is OPTIONAL in implementation, otherwise, this attribute is REQUIRED.

9.3. Semantics

Data Type

All *Data Type* attributes, including *Data Type* and *CV Data Type*, use the enumerated values specified in DeviceNet Vol. I, Appendix J-6.1.

The *Data Type* attribute is settable only in the *Idle State* and only if no attribute belonging to the object instance is the endpoint of an I/O connection in the *Established State*.

The *Data Type* attribute may change automatically based upon established I/O connections. See “9.6. Behavior” for more information on this mechanism.

Data Units

Specifies the context of *Setpoint* and *Process Variable* and related attributes (such as, offset and trip points) for this object instance. See Appendix K for a list of values. A request to set attribute to an unsupported value will return an error response.

The *Data Units* attribute is settable only in the *Idle State*.

In applications where this object is used in a relationship with an S-Analog Sensor object, this attribute may be specified as Get only, by the device profile or the vendor, where the value mirrors that of the S-Analog Sensor object *Data Units* attribute.

Setpoint, Process Variable and Control Variable

These three attributes compose the primary aspects of basic closed-loop control. The *Process Variable* is the measured parameter of the process or system being controlled. The *Setpoint* is the desired value for the measured parameter. By affecting the value of the *Control Variable*, the closed-loop controller drives the process or system to the desired state of:

Process Variable = Setpoint

The *Control Variable* is, therefore, connected to the process or system in such a way that it affects the value of the *Process Variable*. Examples of *Control Variable/Process Variable* combinations include: heater/temperature; valve/flow; or regulator/pressure.

Status

A bit mapped byte, which indicates the Alarm and Warning Exception status of the object instance. The following definition applies:

Bit	Definition
0	Alarm Exception: 0 = cleared; 1 = set
1	Warning Exception: 0 = cleared; 1 = set
2	Reserved
3	Reserved
4	Reserved
5	Reserved
6	Reserved
7	Reserved

Control Mode

This attribute is used to override the value of the *Control Variable* attribute. Further, it may cause the object to modify the internal control algorithm such that a smooth, or “bumpless” transitions occurs upon activating control to setpoint.

The *Safe State* attribute provides a mechanism for override depending upon object state and will take precedents over this. That is, if an object instance implements the *Safe State* attribute and related behavior, then this *Override* attribute and related behavior will only function in the Executing State.

Attribute Value	State
0	Normal
1	Zero/Off/Closed
2	Full/On/Open
3	Hold
4	Safe State
5-63	reserved
64-127	Device Specific (specified by device profile)
128-255	Vendor Specific

Safe State

This attribute specifies what value will be held in the *Control Variable* attribute for states other than Executing. See the S-Device Supervisor object definition in Section 6-48. for a description of object states. The following values are defined:

Attribute Value	State
0	Zero/Off
1	Full Scale/On
2	Hold Last Value
3	Use Safe Value
4-63	Reserved
64-127	Device Specific (specified by device profile)
128-255	Vendor Specific

Safe Value

For Safe State set to Use Safe Value, this attribute holds the value to which the Control Variable attribute will be set for object instance states other than Executing.

Ramp Rate

The ramp rate is limited to values 0 through 32,767. See “9.6. Behavior.”

9.4. S-Single Stage Controller Common Services

Service Code	Need in Implementation		Service Name	Description of Service
	Class	Instance		
0Ehex 14dec	Conditional*	Required	Get_Attribute_Single	Returns the contents of the specified attribute.
10hex 16dec	n/a	Required	Set_Attribute_Single	Modifies an attribute value.
*The Get_Attribute_Single service is REQUIRED if any attributes are implemented.				

See the DeviceNet Communication Model and Protocol for definitions of these common services.

9.5. S-Single Stage Controller Object–Specific Services

The S-Single Stage Controller Object provides no Object–Specific services.

9.6. Behavior

The S-Device Supervisor Object manages the behavior of the S-Single Stage Controller Object. See Section 6. Additionally, this object exhibits the following behavior:

Alarm and Warning Exception Conditions

While in the Executing State as defined by the S-Device Supervisor Object: Immediately upon detecting that the Setpoint does not equal the Process Variable by an amount plus-or-minus the associated (alarm or warning) Error Band, a timer is started. This internal timer is incremented as long as the above condition exists. If the timer exceeds the amount indicated by the associated (alarm or warning) Settling Time and the associated (alarm or warning) Exception Enable is set, then the appropriate (alarm or warning) Exception Condition is set. Note that two internal timers are required in order to support both Alarm and Warning Exception reporting.

This behavior is modified for Ramp Rate values not equal to zero. In such cases, the timer is not enabled until after the expiration of the Ramp Time.

Ramp Rate

For Ramp Rate values other than zero, the S-Single Stage Controller Object internally modifies the Setpoint value in such a way that the Process Variable is “ramped” to its final value. An example follows. A Ramp Rate of 1000 is set and a new Setpoint is sent to the MFC. The setpoint feed to the controller will be internally (transparently) modified, in whatever time increments the object is able to sustain, in order to affect a smooth transition over one second from the old Setpoint to the new Setpoint, finally reaching the new Setpoint at the one second mark.

Note: The GF100 Series supports Ramp Rates from 1000ms to 32767ms. Rates greater than 7FFFh will return an error. Rates below 1000ms will be accepted; however, the ramping algorithm will not be invoked.

Data Type

If the implementation of this object specifies more than one valid Data Type value, in the device profile or by vendor, then the following behavior with respect to *Data Type* applies. The Data Type value will be set automatically based upon the first valid I/O connection established by the device. This configuration will then remain in effect for this object instance even, after all I/O connections are lost. For devices that support only one Data Type, this behavior is not supported.

If no established I/O connections exist, which include an attribute from this object, then the *Data Type* attribute is settable provided that the object is in the *Idle State*.

The following example demonstrates this behavior:

A device profile specifies an instance of the S-Single Stage Controller object as well as two static Assembly object instances, both with data attribute components mapped to this object instance. Assembly object instance ID 1 specifies INT data types and Assembly object instance ID 2 specifies REAL data types.

After the device is On-Line, it is configured with an I/O connection to Assembly instance ID 2. When the connection transitions to the *Established State*, this object instance attribute *Data Type* is automatically set with the value for REAL before any data is communicated to, or from, the object instance.

GF100 Series implementation

Data Type values supported are Integer (0xC3) and Real (0xCA). Data Units supported are Counts (0x1001) and SCCM (0x1400). Data Type and Data Units attributes are settable. The supported combinations of Data Type and Data Units on the GF100 Series are Integer-Counts (default), Real-SCCM, Integer-SCCM, and Real-Counts. The full-scale range for Integer-Counts is either 0x6000 or 0x7FFF, depending on the configuration. The MFC Device Profile specifies that the full-scale range for the setpoint is 0x7FFF; however, the default GF100 Series configuration supports a full-scale setpoint range of 0 to 0x6000.

Control

The application of this object is further specified in the applicable device profile; primarily, the interfaces and object relationships are defined. Generally, the *Process Variable* attribute is restricted to "Get Only" access and an internal connection is defined to another object. Similarly, the *Control Variable* is generally not supported due to internal connections.

When in the EXECUTING state, this object is running an application process designed to cause the *Process Variable* to be driven to the value of the *Setpoint*. In any state other than EXECUTING, the application process is stopped and the *Safe State* is activated for the output of the object.

Any fault detected by the object application process causes the object to transition to the appropriate state as defined by the managing S-Device Supervisor object.

10. S-Gas Calibration Object (Class 0x34)

An S-Gas Calibration Object affects the behavior of an associated S-Analog Sensor object instance; a device profile will show a relationship between these two objects where an S-Gas Calibration Object is used. The S-Analog Sensor object uses a selection attribute as the gas type selection mechanism. The S-Gas Calibration Object provides the data with which a device enacts the appropriate calibration algorithm for a given gas type. Each S-Gas Calibration Object Instance contains a set of attribute values for one particular calibration set; each identified by the Gas Standard Number.

The S-Gas Calibration class level object provides a service for retrieving a list of all valid object instances. The service response includes a list of elements. Each element includes the Instance ID, Gas Standard Number and the valid S-Analog Sensor object instance ID for which the instance is valid.

There may be more than one instance with the same Gas Standard Number. These instances may be differentiated by Full Scale, Gas Symbol, Additional Scaler and/or other parametric distinctions, including valid S-Analog Sensor object instance ID. The distinctions may, or may not, be evident in the Get_All_Instances service response, depending upon what the distinction is.

S-Gas Calibration Objects most often utilize the region of Manufacturer Specified Attributes (ID > 100) for specific calibration parameters.

This object is a member of the *Hierarchy of Semiconductor Equipment Devices*. As such, its behavior is managed by the Device Supervisor Object. See Section 6.

The S-Gas Calibration object makes use of a list of Standard Gas Type Numbers. This list is described in publication:

SEMI E52-95 "Practice for Referencing Gases Used in Digital Mass Flow Controllers", Semiconductor Equipment and Materials International (SEMI), Mountain View, CA 94043-4080.

Note: It is implied that the reference above is to the latest revision as specified by SEMI.

Brooks DeviceNet PCs/PMs

10.1. S-Gas Calibration Class Attributes

The Object Class Attribute ID 1-7 are reserved. See DeviceNet Volume II, Section 5-4.1. for more specification detail on these attributes.

Attribute ID	Need in Implementation	Access Rule	Name	DeviceNet Data Type	Description of Attribute
1 thru 7	These class attributes are either optional or conditional and are described in chapter 5 of this specification.				
97 & 98	Reserved by DeviceNet				
99	Conditional * (Supported)	Get	Subclass	UINT	Identifies a subset of additional attributes, services and behaviors. The subclasses for this object are specified at the end of this object specification section.
170	Optional (Supported)	Get	Bin ID	INT	Specifies the Device Bin number. This value is vendor specific. **

* If the value of Subclass is 00, which identifies "no subclass", then this attribute is *OPTIONAL* in implementation, otherwise, this attribute is *REQUIRED*.

** This class attribute is required for certain customer applications, such as the "multi-gas, multi-range" application.

10.2. S-Gas Calibration Instance Attributes

Certain minimal implementations may support any optional “Set” attributes as “Get” only and still be compliant with this object specification. All required attributes must be supported as specified. The GF100 Series supports 9 instances of the S-Gas Calibration Object.

Attr ID	Need in Implementation	Access Rule	NV*	Name	DeviceNet Data Type	Description of Attribute	Semantics of Values
1	Optional (Not Supported)	Get	NV	Number of Attributes	USINT	Number of attributes supported	Number of attributes supported in this object instance
2	Optional (Not Supported)	Get	NV	Attribute List	ARRAY OF USINT	List of attributes supported by this object instance	List of attributes supported in this object instance
3	Required	Get	NV	Gas Standard Number	UINT	Gas Type Number	[default] = 0 (no gas type specified) See “10.3. Semantics.”
4	Required	Get	NV	Valid Sensor Instance	UINT	S-Analog Sensor object instance ID for which this object instance is valid	0 = No Valid Sensor n = Instance ID See “10.3. Semantics.” [default] = 0
5	Optional (Supported)	Set	NV	Gas Symbol	SHORT STRING	Gas Type Name	See “10.3. Semantics.” [default] = null
6	Optional (Supported)	Get	NV	Full Scale	STRUCT of:	Full Scale of the device using this object instance	See “10.3. Semantics.” [default] = 0, 0
					REAL	Amount	The amount of measured parameter corresponding to full scale.
					UINT	Units	The units for the above. See Data Units Appendix K.

Brooks DeviceNet PCs/PMs

Attr ID	Need in Implementation	Access Rule	NV*	Name	DeviceNet Data Type	Description of Attribute	Semantics of Values
7	Optional (Not Supported)	Set	NV	Additional Scaler	REAL	Additional Correction Factor	In addition to the correction algorithm, this amount is multiplied to the reading. Generally used for Gas Correction for a gas other than the type identified for the object instance by attribute 3. (E.g., scale a nitrogen object instance to measure argon). Default = 1.0
8	Optional (Supported)	Get	NV	Calibration Date	DATE	Date of Calibration	The date this object instance was last calibrated [default] = 0
9	Optional (Supported)	Get	NV	Calibration Gas Number	UINT	Calibration Gas	The gas number of the gas used to calibrate this object instance. [default] = 0
10	Optional (Not Supported)	Get	NV	Gas Correction Factor	REAL	Gas Correction Factor For devices that support simple correction factors (as opposed to algorithms) for gas selection.	[default] = 1.0
97-98	Reserved by DeviceNet						
99	Conditional ** (Supported)	Get	NV	Subclass	UINT	Identifies a subset of additional attributes, services and behaviors. The subclasses for this object are specified at the end of this object specification section.	0 = No subclass n = subclass as defined herein

* NV = Nonvolatile; value is maintained through power cycle.

** If the value of Subclass is 00, then this attribute is OPTIONAL in implementation, otherwise, this attribute is REQUIRED.

10.3. Semantics

Gas Standard Number

Used to identify a gas standard number, for which the object instance is currently calibrated. See Instance Application Example below.

The actual coding of the values are described in the following publication:

See "1. Introduction" for reference to the SEMI publication: *Practice for Referencing Gases Used in Digital Mass Flow Controllers*.

Since the actual attributes, and their context, for the parameterization of object instances for particular gas types is beyond the scope of this standard (i.e., vendor specific) the Access Rule for this attribute has been specified as Get. Vendors may choose to specify an Access Rule of Set for this attribute.

Valid Sensor Instances

This attribute specifies the S-Analog Sensor object instance for which the S-Gas Calibration object instance is valid. An S-Gas Calibration object instance will be valid for zero or one S-Analog Sensor object instances.

Gas Symbol

This optional attribute is a string-coded representation of the name of the gas for which the object instance has been configured. It is coded as a user defined text symbol or it is coded as defined in the above referenced SEMI publication.

This attribute may indicate a different gas from the one, which has been specified by the Gas Standard Number. See Instance Application Example below.

Full Scale

This optional attribute identifies the amount of measured parameter (e.g., Mass Flow) corresponding to the Full Scale of the associated S-Analog Sensor object. A primary purpose for this attribute is to allow for simple S-Analog Sensor object implementations where the Value is reported in raw units; this attribute allows a mapping to engineering units.

For example, the Full Scale for a S-Gas Calibration object may be 100 SCCM, while the Full Scale for the associated S-Analog Sensor object may be 0x6000 counts (i.e., S-Analog Sensor object Data Type = INT and Data Units = Counts).

Instance Application Example

The following is an example to demonstrate the usage of Gas Calibration object instances and their attributes:

A device has been supplied with three gas calibration object instances: nitrogen (13)*, helium (1)* and argon (4)*. The user wishes to use the device for silane (39)* and knows that a correction factor of 0.60 will properly convert a nitrogen calibration for this application. The object instance for nitrogen would be selected and the Additional Scaler attribute for this instance would be set to 0.60. To identify this modification, the Gas Symbol may be set to read “silane”, “SiH4”, or “39”.

* (Gas Standard Number)

10.4. S-Gas Calibration Common Services

Service Code	Need in Implementation		Service Name	Description of Service
	Class	Instance		
0Ehex 14dec	Required	Required	Get_Attribute_Single	Returns the contents of the specified attribute.
10hex 16dec	Required	Required	Set_Attribute_Single	Modifies an attribute value.

See the DeviceNet Communication Model and Protocol for definitions of these common services.

10.5. S-Gas Calibration Object-Specific Services

Service Code	Need in Implementation		Service Name	Description of Service
	Class	Instance		
4Bhex 75dec	Required	n/a	Get_All_Instances	Requests a list of all available object instances with their respective gas numbers

If a gas instance is changed or added, the device must be reset before performing the “get_all_instances” service.

Success Response Service Data Field Parameters

Parameter	Required	Data Type	Description	Semantics of Values
Size of List	Required	UINT	Specifies the number of elements in the Array	Number of gas calibrations in the list
List of Gas Calibrations	Required if Size > 0	ARRAY of	Supported List	The list of gas calibrations
		STRUCT of	Supported Gas Type	
		UINT	S-Gas Calibration Object Instance ID	[34-n-4], where n is the instance value 1 – 9.
		UINT	Gas Standard Number	[34-n-3], where n is the instance value 1 – 9.
		UINT	Valid Sensor Instance	Always =1 for the GF100 Series.

On the GF100 Series: Gas instance 6 is considered the “test” gas instance. There are a total of 6 gas instances, (sometimes referred to as “gas pages”) available.

10.6. S-Gas Calibration Object Behavior

The behavior of this object is managed by the Device Supervisor Object, defined in Section 6-48.5.

Brooks DeviceNet PCs/PMs

10.7. S-Gas Calibration Object Instance Subclass 01

The following specification applies to a subclass of this object for application in Mass Flow Controller devices.

10.7.1. Subclass01 Instance Attributes

Attribute ID	Need in Implementation	Access Rule	Name	DeviceNet Data Type	Description of Attribute	Semantics of Values
95	Optional (Supported)	Get	Calibration Pressure	REAL	The gas pressure in KiloPascal	The Standard Pressure with respect to the calibration conditions. Default = 101.32, (14.7 PSIA).
96	Optional (Not Supported)	Get	Calibration Temperature	REAL	The Gas Temperature in Degrees C	The Standard Temperature with respect to the calibration conditions. Default = 0.0

10.7.2. Subclass 01 Instance Services

There are no additions or restrictions to the Object Services for this object subclass.

10.7.3. Subclass 01 Behavior

There are no additions or restrictions to the Behavior for this object subclass.

11. Advanced Diagnostics (GF135 Only)

11.1. New Communication Protocol Overview

11.1.1. Objectives and Problem Statement

Through the years, issues found in the field on Brooks MFCs have been very difficult to troubleshoot due to lack of information given to failure analysis teams. Issues that are random in occurrence and are specific to the field setup are the most difficult to reproduce therefore troubleshooting takes longer.

This new communication capability will enable the device to perform a series of self validation at regular interval and report its status to the tool software. Some of the self validation will require at least knowing the state of certain part of the tool over which the device typically had neither control nor access. The capabilities of the GF135 will enable short interval control of the upstream isolation valve in a manner consistent with good safety practices.

Those capabilities do not exist in any protocol currently in use in the field.

11.1.2. Protocol Description

The communication protocol shall be implemented over RS485 physical layer.

The protocol shall be able to handle the following type of communications between the device and the tool:

- Tool request for Commissioning status
- Tool request for valve leak status, ROD measurements

These are the minimum requirements to support advanced diagnostics.

Brooks DeviceNet PCs/PMs

11.2. Specific Requirements**11.2.1. Introduction**

The following requirements are a subset of Brooks' new communication protocol definition.

11.2.2. Advanced Protocol

The advanced communication protocol is more fully defined in GF135-SRS-011.

11.2.3. New Attributes

Note: Those attributes are valid as of the date of writing. Attribute ID are subject to change and new attributes will likely be added by the time this document is finalized.

New attributes for the advanced diagnostic:

Attribute	Access	Class	Instance	Att. ID	Values
isolation valve status	READ ONLY	177	1	3	0: Upstream open 1: Upstream closed
ROD delay	Read/Write	177	1	20	Delay before first ROD measurement after a setpoint change (seconds). Minimum = default = 4 sec.
ROD interval	Read/Write	177	1	21	Interval between ROD measurement when setpoint is constant (seconds). Minimum = 5 sec. Default = 10 sec.
ROD enable Default flag	Read/Write	177	1	55	0: ROD is disabled 1: ROD is enabled Non Volatile. Copied to Attribute 62 at power up. Default = Enabled

Attribute	Access	Class	Instance	Att. ID	Values
ROD Error Status	READ ONLY	177	1	56	0: ROD Error (attribute 11) is not valid 1: ROD Error (attribute 11) is valid
Valve Leak status	READ ONLY	177	1	57	0: Valve Leak Meas. is not valid 1: Valve Leak Meas. is valid
Valve Leak value	READ ONLY	177	1	59	Float, fraction of configured range
ROD Current Setpoint	READ ONLY	177	1	60	Current setpoint at which the ROD is being measured (see attribute 11) (fraction of configured range)
ROD error	READ ONLY	177	1	61	ROD measured flow change (from baseline) in % SP for the current setpoint. Same as ROD error N.
ROD enable flag	Read/Write	177	1	62	0: ROD is disabled 1: ROD is enabled Volatile
Commissioning status	Read/Write	103	n	132	0: Not done or failed 1: Commissioning was successful
ROD 0 Status	READ ONLY	177	1	70	0: ROD Error 0 is not valid 1: ROD Error 0 is valid
ROD 1 Status	READ ONLY	177	1	71	0: ROD Error 1 is not valid 1: ROD Error 1 is valid
ROD 2 Status	READ ONLY	177	1	72	0: ROD Error 2 is not valid 1: ROD Error 2 is valid
ROD 3 Status	READ ONLY	177	1	73	0: ROD Error 3 is not valid 1: ROD Error 3 is valid
ROD 4 Status	READ ONLY	177	1	74	0: ROD Error 4 is not valid 1: ROD Error 4 is valid
ROD 5 Status	READ ONLY	177	1	75	0: ROD Error 5 is not valid 1: ROD Error 5 is valid
ROD 6 Status	READ ONLY	177	1	76	0: ROD Error 6 is not valid 1: ROD Error 6 is valid
ROD 7 Status	READ ONLY	177	1	77	0: ROD Error 7 is not valid 1: ROD Error 7 is valid
ROD 8 Status	READ ONLY	177	1	78	0: ROD Error 8 is not valid 1: ROD Error 8 is valid
ROD 9 Status	READ ONLY	177	1	79	0: ROD Error 9 is not valid 1: ROD Error 9 is valid
ROD 10 Status	READ ONLY	177	1	80	0: ROD Error 10 is not valid 1: ROD Error 10 is valid

Brooks DeviceNet PCs/PMs

Attribute	Access	Class	Instance	Att. ID	Values
ROD 11 Status	READ ONLY	177	1	81	0: ROD Error 11 is not valid 1: ROD Error 11 is valid
ROD 12 Status	READ ONLY	177	1	82	0: ROD Error12 is not valid 1: ROD Error 12 is valid
ROD 13 Status	READ ONLY	177	1	83	0: ROD Error 13 is not valid 1: ROD Error 13 is valid
ROD 14 Status	READ ONLY	177	1	84	0: ROD Error 14 is not valid 1: ROD Error 14 is valid
ROD 15 Status	READ ONLY	177	1	85	0: ROD Error 15 is not valid 1: ROD Error 15 is valid
ROD 16 Status	READ ONLY	177	1	86	0: ROD Error 16 is not valid 1: ROD Error 16 is valid
ROD 17 Status	READ ONLY	177	1	87	0: ROD Error 17 is not valid 1: ROD Error 17 is valid
ROD 18 Status	READ ONLY	177	1	88	0: ROD Error 18 is not valid 1: ROD Error 18 is valid
ROD 19 Status	READ ONLY	177	1	89	0: ROD Error 19 is not valid 1: ROD Error 19 is valid
ROD Error 0	READ ONLY	177	1	90	Float, Avg. error for setpoint 0-5%
ROD Error 1	READ ONLY	177	1	91	Float, Avg. error for setpoint 5-10%
ROD Error 2	READ ONLY	177	1	92	Float, Avg. error for setpoint 10-15%
ROD Error 3	READ ONLY	177	1	93	Float, Avg. error for setpoint 15-20%
ROD Error 4	READ ONLY	177	1	94	Float, Avg. error for setpoint 20-25%
ROD Error 5	READ ONLY	177	1	95	Float, Avg. error for setpoint 25-30%
ROD Error 6	READ ONLY	177	1	96	Float, Avg. error for setpoint 30-35%
ROD Error 7	READ ONLY	177	1	97	Float, Avg. error for setpoint 35-40%
ROD Error 8	READ ONLY	177	1	98	Float, Avg. error for setpoint 40-45%
ROD Error 9	READ ONLY	177	1	99	Float, Avg. error for setpoint 45-50%
ROD Error 10	READ ONLY	177	1	100	Float, Avg. error for setpoint 50-55%
ROD Error 11	READ ONLY	177	1	101	Float, Avg. error for setpoint 55-60%
ROD Error 12	READ ONLY	177	1	102	Float, Avg. error for setpoint 60-65%
ROD Error 13	READ ONLY	177	1	103	Float, Avg. error for setpoint 65-70%
ROD Error 14	READ ONLY	177	1	104	Float, Avg. error for setpoint 70-75%
ROD Error 15	READ ONLY	177	1	105	Float, Avg. error for setpoint 75-80%
ROD Error 16	READ ONLY	177	1	106	Float, Avg. error for setpoint 80-85%

Attribute	Access	Class	Instance	Att. ID	Values
ROD Error 17	READ ONLY	177	1	107	Float, Avg. error for setpoint 85-90%
ROD Error 18	READ ONLY	177	1	108	Float, Avg. error for setpoint 90-95%
ROD Error 19	READ ONLY	177	1	109	Float, Avg. error for setpoint 95-100%

The following set of attributes is required for the data logging and trending:

Attribute	Access	Class	Instance	Att. ID	Values
Time Synchronization	WRITE ONLY	0x43 (67)	1	TBD	Time and date information Not implemented
Data Request	READ ONLY	0x41 (65)	1	TBD	Trending information Not implemented

11.3. Tool – Device Communication

The following items need to be addressed with the customer to define the new advanced diagnostic protocol:

Tool to provide status (e.g. isolation valve status upstream and downstream)

Some operations require knowing the status of the isolation valves on both sides of the device. The tool shall provide this information by writing to the isolation valve status attribute whenever the status changes.

Note: At this time, this is not implemented on the customer tool software.

Request from the device to the tool to modify the tool status (e.g. Operating the isolation valves at the request of the MFC)

Some operations require a specific state of the isolation valves on both sides of the device. The tool shall read the isolation valve request attribute on a schedule TBD and satisfy the request of the MFC.

Note: At this time, this is not implemented on the customer tool software.

Time synchronization

In order to provide accurate data logging for the trending diagnostic, the tool will need to provide accurate time synchronization. The MFC is capable of running a real time clock, so only occasional synchronization is required (at least once per power on cycle)

Note: At this time, this is not implemented on the customer tool software.

Request from the tool for some trending information

Data can be logged at regular interval and time stamped using the time information

Data can be retrieved by the customer to provide long term trend (e.g. zero information logged once per week)

Note: At this time, this is only supported via the diagnostic port.

12. References

¹ S-Device Supervisor Object. Open DeviceNet Venders Association (ODVA) DeviceNet Specification Enhancement 93-01. Version J. 1/27/1999.

² S-Analog Sensor Object. Open DeviceNet Venders Association (ODVA) DeviceNet Specification Enhancement 93-02. Version J. 1/27/1999.

³ S-Analog Actuator Object. Open DeviceNet Venders Association (ODVA) DeviceNet Specification Enhancement 93-03. Version J. 1/27/1999.

⁴ S-Single Stage Controller Object. Open DeviceNet Venders Association (ODVA) DeviceNet Specification Enhancement 93-04. Version J. 1/27/1999.

⁵ S-Gas Calibration Object. Open DeviceNet Venders Association (ODVA) DeviceNet Specification Enhancement 93-05. Version J. 1/27/1999.

⁶ Mass-Flow Controller Device Profile. Open DeviceNet Venders Association (ODVA) DeviceNet Specification Enhancement 93-06. Version J. 1/27/1999.

⁷ Open DeviceNet Venders Association (ODVA) DeviceNet Specification, Volume 1 and 2. Version 2.0. 12/2/1998.

*THIS PAGE WAS
INTENTIONALLY
LEFT BLANK*

Installation and Operation Manual

X-DPT-RS485-GF100-Series-MFC-eng

Part Number: 541B183AAG

March, 2013

Brooks DeviceNet PCs/PMs

*THIS PAGE WAS
INTENTIONALLY
LEFT BLANK*

Brooks DeviceNet PCs/PMs

LIMITED WARRANTY

Seller warrants that the Goods manufactured by Seller will be free from defects in materials or workmanship under normal use and service and that the Software will execute the programming instructions provided by Seller until the expiration of the earlier of twelve (12) months from the date of initial installation or eighteen (18) months from the date of shipment by Seller. Products purchased by Seller from a third party for resale to Buyer ("Resale Products") shall carry only the warranty extended by the original manufacturer.

All replacements or repairs necessitated by inadequate preventive maintenance, or by normal wear and usage, or by fault of Buyer, or by unsuitable power sources or by attack or deterioration under unsuitable environmental conditions, or by abuse, accident, alteration, misuse, improper installation, modification, repair, storage or handling, or any other cause not the fault of Seller are not covered by this limited warranty, and shall be at Buyer's expense.

Goods repaired and parts replaced during the warranty period shall be in warranty for the remainder of the original warranty period or ninety (90) days, whichever is longer. This limited warranty is the only warranty made by Seller and can be amended only in a writing signed by an authorized representative of Seller.

BROOKS SERVICE AND SUPPORT

Brooks is committed to assuring all of our customers receive the ideal flow solution for their application, along with outstanding service and support to back it up. We operate first class repair facilities located around the world to provide rapid response and support. Each location utilizes primary standard calibration equipment to ensure accuracy and reliability for repairs and recalibration and is certified by our local Weights and Measures Authorities and traceable to the relevant International Standards.

Visit www.BrooksInstrument.com to locate the service location nearest to you.

START-UP SERVICE AND IN-SITU CALIBRATION

Brooks Instrument can provide start-up service prior to operation when required.

For some process applications, where ISO-9001 Quality Certification is important, it is mandatory to verify and/or (re)calibrate the products periodically. In many cases this service can be provided under in-situ conditions, and the results will be traceable to the relevant international quality standards.









CUSTOMER SEMINARS AND TRAINING

Brooks Instrument can provide customer seminars and dedicated training to engineers, end users and maintenance persons.

Please contact your nearest sales representative for more details.

HELP DESK

In case you need technical assistance:

USA		888 275 8946	Korea		+82 31 708 2521
Netherlands		+31 (0) 318 549290	Taiwan		+886 3 5590 988
Germany		+49 351 215 2040	China		+86 21 5079 8828
Japan		+81 3 5633 7100	Singapore		+6297 9741



Due to Brooks Instrument's commitment to continuous improvement of our products, all specifications are subject to change without notice.

TRADEMARKS

Brooks .
DeviceNet

Brooks Instrument, LLC
Open DeviceNet Vendors Association, Inc.

Brooks Instrument
407 West Vine Street
P.O. Box 903
Hatfield, PA 19440-0903 USA
T (215) 362 3700
F (215) 362 3745
E-Mail BrooksAm@BrooksInstrument.com
www.BrooksInstrument.com

Brooks Instrument
Neonstraat 3
6718 WX Ede, Netherlands
T +31 (0) 318 549 300
F +31 (0) 318 549 309
E-Mail BrooksEu@BrooksInstrument.com

Brooks Instrument
1-4-4 Kitasuna Koto-Ku
Tokyo, 136-0073 Japan
T +81 (0) 3 5633 7100
F +81 (0) 3 5633 7101
E-Mail BrooksAs@BrooksInstrument.com



Brooks® GF100 Series High Purity/Ultra-High Purity Digital Thermal Mass Flow Devices



Model GF125 Analog I/O



Model GF125 Digital I/O



Model GF135 Analog I/O



Model GF121 Analog I/O

Essential Instructions Read before proceeding!

Brooks Instrument designs, manufactures and tests its products to meet many national and international standards. These products must be properly installed, operated and maintained to ensure they continue to operate within their normal specifications. The following instructions must be adhered to and integrated into your safety program when installing, operating and maintaining Brooks Instrument products.

- To ensure proper performance, use qualified personnel to install, operate, update, program and maintain the product.
- Read all instructions prior to installing, operating and servicing the product. If this instruction manual is not the correct manual, please see back cover for local sales office contact information. Save this instruction manual for future reference.

▲ WARNING: Do not operate this instrument in excess of the specifications listed in the Instruction and Operation Manual. Failure to heed this warning can result in serious personal injury and / or damage to the equipment.

- If you do not understand any of the instructions, contact your Brooks Instrument representative for clarification.
- Follow all warnings, cautions and instructions marked on and supplied with the product.

▲ WARNING: Prior to installation ensure this instrument has the required approval ratings to meet local and national codes. Failure to heed this warning can result in serious personal injury and / or damage to the equipment.

- Install your equipment as specified in the installation instructions of the appropriate instruction manual and per applicable local and national codes. Connect all products to the proper electrical and pressure sources.
- Operation: (1) Slowly initiate flow into the system. Open process valves slowly to avoid flow surges. (2) Check for leaks around the flow meter inlet and outlet connections. If no leaks are present, bring the system up to the operating pressure.
- Please make sure that the process line pressure is removed prior to service. When replacement parts are required, ensure that qualified people use replacement parts specified by Brooks Instrument. Unauthorized parts and procedures can affect the product's performance and place the safe operation of your process at risk. Look-alike substitutions may result in fire, electrical hazards or improper operation.
- Ensure that all equipment doors are closed and protective covers are in place to prevent electrical shock and personal injury, except when maintenance is being performed by qualified persons.

▲ WARNING: For liquid flow devices, if the inlet and outlet valves adjacent to the devices are to be closed for any reason, the devices must be completely drained. Failure to do so may result in thermal expansion of the liquid that can rupture the device and may cause personal injury.

European Pressure Equipment Directive (PED)

All pressure equipment with an internal pressure greater than 0.5 bar (g) and a size larger than 25mm or 1" (inch) falls under the Pressure Equipment Directive (PED).

- The Specifications Section of this manual contains instructions related to the PED directive.
- Products described in this manual are in compliance with EN directive 2014/34/EU.
- All Brooks Instrument Flowmeters fall under fluid group 1.
- Products larger than 25mm or 1" (inch) are in compliance with PED category I, II or III.
- Products of 25mm or 1" (inch) or smaller are Sound Engineering Practice (SEP).

European Electromagnetic Compatibility (EMC)

The Brooks Instrument (electric/electronic) equipment bearing the CE mark has been successfully tested to the regulations of the Electro Magnetic Compatibility (EMC directive 2014/30/EU).

Special attention however is required when selecting the signal cable to be used with CE marked equipment.

Quality of the signal cable, cable glands and connectors:

Brooks Instrument supplies high quality cable(s) which meets the specifications for CE certification.

If you provide your own signal cable you should use a cable which is overall completely screened with a 100% shield.

"D" or "Circular" type connectors used should be shielded with a metal shield. If applicable, metal cable glands must be used providing cable screen clamping.

The cable screen should be connected to the metal shell or gland and shielded at both ends over 360 Degrees.

The shield should be terminated to an earth ground.

Card Edge Connectors are standard non-metallic. The cables used must be screened with 100% shield to comply with CE certification.

The shield should be terminated to an earth ground.

For pin configuration : Please refer to the enclosed Instruction Manual.

ESD (Electrostatic Discharge)

▲ CAUTION: This instrument contains electronic components that are susceptible to damage by static electricity. Proper handling procedures must be observed during the removal, installation or other handling of internal circuit boards or devices.

Handling Procedure:

1. Power to unit must be removed.
2. Personnel must be grounded, via a wrist strap or other safe, suitable means before any printed circuit card or other internal device is installed, removed or adjusted.
3. Printed circuit cards must be transported in a conductive container. Boards must not be removed from protective enclosure until immediately before installation. Removed boards must immediately be placed in protective container for transport, storage or return to factory.

Comments

This instrument is not unique in its content of ESD (electrostatic discharge) sensitive components. Most modern electronic designs contain components that utilize metal oxide technology (NMOS, SMOS, etc.). Experience has proven that even small amounts of static electricity can damage or destroy these devices. Damaged components, even though they appear to function properly, exhibit early failure.

Installation and Operation Manual

X-TMF-GF100-Series-MFC-eng

Part Number: 541B137AAG

April, 2017

GF100 Series

Dear Customer,

We appreciate this opportunity to service your flow measurement and control requirements with a Brooks Instrument device. Every day, flow customers all over the world turn to Brooks Instrument for solutions to their gas and liquid low-flow applications. Brooks provides an array of flow measurement and control products for various industries from biopharmaceuticals, oil and gas, fuel cell research and chemicals, to medical devices, analytical instrumentation, semiconductor manufacturing, and more.

The Brooks product you have just received is of the highest quality available, offering superior performance, reliability and value to the user. It is designed with the ever changing process conditions, accuracy requirements and hostile process environments in mind to provide you with a lifetime of dependable service.

We recommend that you read this manual in its entirety. Should you require any additional information concerning Brooks products and services, please contact your local Brooks Sales and Service Office listed on the back cover of this manual or visit www.BrooksInstrument.com.

Yours sincerely,

Brooks Instrument

*THIS PAGE WAS
INTENTIONALLY
LEFT BLANK*

<u>Paragraph Number</u>	<u>Page Number</u>
Section 1 General Information	
1-1 Introduction	1-1
1-2 How to Use This Manual	1-1
1-3 Product Support References	1-2
1-4 Notice and Caution Statements	1-2
1-5 Product Warranty	1-2
1-6 How to Order a GF100 Series Device	1-2
1-7 Industry Standard References	1-2
1-8 GF100 Series Gas Table	1-2
1-9 Glossary of Terms and Acronyms	1-2
1-10 Description	1-5
1-11 Specifications for GF100 Series Devices	1-8
Section 2 Installation	
2-1 General	2-1
2-2 Receipt of Equipment	2-1
2-3 Recommended Storage Practice	2-1
2-4 Return Shipment	2-1
2-5 Transit Precautions	2-2
2-6 Removal from Storage	2-2
2-7 Gas Connections	2-2
2-8 In-Line Filter	2-2
2-9 Mechanical Installation	2-2
2-10 Flow Controller Installation Arrangement	2-3
2-11 Purge the Gas Supply Line Before GF100 Series Installation	2-4
2-12 Position and Mount the GF100 Series	2-5
2-13 Perform a Leak Test	2-7
2-14 Zeroing Setup Process	2-7
2-15 Zeroing the GF100 Series	2-7
2-15-1 Zeroing the GF100 Series Pressure Transducer from the LCD Display Panel	2-8
2-15-2 Zeroing GF100 Series Flow from LCD Display Panel	2-9
2-16 Performance Checks	2-9
2-17 Introduction to the MultiFlo™ Configurator	2-10
2-18 Using the MultiFlo Configurator	2-10
2-19 Electrical Connections	2-12
2-19-1 DeviceNet Connections	2-12
2-19-2 Analog/RS485 Connections	2-13
2-19-3 EtherCat Connections	2-14
2-20 GF135 Inlet Valve Installation	2-16
2-21 GF135 Commissioning	2-17
Section 3 Operation	
3-1 General	3-1
3-2 Theory of Operation for Flow Measurement	3-1
Section 4 Maintenance & Troubleshooting	
4-1 Overview	4-1
4-2 Maintenance	4-1
4-3 Troubleshooting	4-3
4-4 Troubleshooting Checklist	4-3
4-5 GF100 Series Troubleshooting Guide	4-4
Section 5 Product Description Code	
5-1 Overview	5-1
Appendix A: GF100 Series Gas Table	
A-1 Overview	A-1
Appendix B: GF100 Series Patents	
B-1 Overview	B-1
Appendix C: Essential Instructions	
C-1 Overview	C-1
Warranty, Local Sales/Service Contact Information	Back Cover

GF100 Series

<u>Figure Number</u>		<u>Page Number</u>
1-1	GF100 Series High Performance Gas Flow Controller Analog and Digital	1-1
1-2	LCD Display	1-7
1-3	Dimensions - GF100/GF120/GF125 Series	1-15
1-4	Dimensions - GF135, DeviceNet	1-16
1-5	Dimensions - GF135, RS485	1-17
1-6	Dimensions - GF101/GF121/GF126	1-18
1-8	Dimensions - GF100/GF120/GF125, GF101/GF121/GF126 Series with EtherCAT Communications	1-19
2-1	Typical Gas Supply Arrangement with Non-PTI MFC	2-4
2-2	Typical Gas Supply Arrangement with PTI MFC	2-4
2-3	GF100 Series Mounting Attitude Positions	2-5
2-4	GF100 Series Mounted to K1 Series Substrate Blocks	2-6
2-5	Mounting Screws Torque Pattern	2-6
2-6	Display with PSI Reading	2-8
2-7	Display Reading Zero PSI	2-8
2-8	Display Set to %FS	2-10
2-9	% Flow Display Set to Zero	2-10
2-10	MultiFlo Cable Adapter	2-11
2-11	USB-RS485 Converter (214F027AAA)	2-11
2-12	Diagnostic Port Locations	2-11
2-13	GF100 Series DeviceNet Connection	2-12
2-14	GF100 Series with 9-Pin Analog Connector	2-15
2-15	Analog 9-Pin Connector (M)	2-15
2-16	GF100 with EtherCat Communications, M8 Power Connector Location	2-14
2-17	M8 Power Connector Drawing	2-14
2-18	GF100 Series Electrical Interface Options	2-15
2-19	GF135 Series Showing Inlet/Outlet Pneumatic Isolation Valve Lines	2-16
3-1	GF100 Series Operating Principles	3-2

<u>Table Number</u>		<u>Page Number</u>
1-1	Industry Standard References	1-3
1-2	Terms and Acronyms	1-4
1-3	Specifications for Standard GF100/GF120/GF125 Series	1-9
1-4	Specifications for Safe Delivery System (SDS) GF120 Series	1-10
1-3	Specifications for GF100/GF120/GF125 Series with EtherCAT Communications	1-11
1-6	Specifications for GF135 Series	1-12
1-7	Specifications for GF101/GF121/GF126 Series	1-13
1-8	Specifications for GF101/GF121/GF126 Series with EtherCAT Communications	1-14
2-1	K1 Series Fasteners	2-7
2-2	K1 Substrate Torque Data	2-7
2-3	Gas and Flow Ranges - MultiFlo Configurable - N2 Equivalent	2-10
4-1	Environmental Factors	4-3
4-2	GF100 Series Troubleshooting Guide	4-4
5-1	GF100, GF120 & GF125 Series Product Description Code	5-1
5-2	GF100, GF120 & GF125 Series with EtherCAT Communications Product Description Code	5-3
5-3	Model GF135 Product Description Code	5-4
5-4	GF101, GF121 & GF126 Series Product Description Code	5-5
5-5	GF101, GF121 & GF126 Series with EtherCAT Communications Product Description Code	5-6
A-1A	GF100 Series Gas Table - Codes 1-108, Bins SH40 to SH50	A-1
A-1B	GF100 Series Gas Table - Codes 109-875, Bins SH40 to SH50	A-2
A-1C	GF100 Series Gas Table - Codes 878-5022, Bins SH40 to SH50	A-2
B-1	GF100 Series Patents	B-1

1-1 Introduction

Designed for semiconductor, MOCVD, and other gas flow control applications that require a high purity all-metal flow path, the Brooks GF100 Series mass flow controllers and meters deliver outstanding performance, reliability, and flexibility. Process throughput and yield are maximized while process costs are reduced by the GF100 Series featuring:

- Ultra fast settling time for quick start up and very rapid process steps
- MultiFlo™ gas and range configurability enabling reconfiguration without removing device from the gas line
- An independent diagnostic/service port to troubleshoot or change flow conditions without removing the mass flow controller from service
- Long-term stability due to extremely low wetted surface area, and corrosion resistant Hastelloy® sensor and valve seat

Optional model variations including—pressure transient insensitivity (PTI) and Safe Delivery System (SDS)

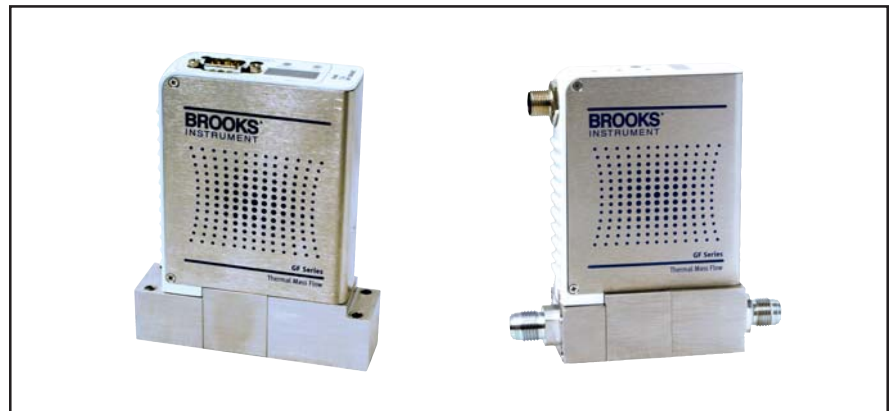

Figure 1-1 GF100 Series High Performance Gas Flow Controller Analog and Digital

1-2 How to Use This Manual

This manual is intended to provide the user with all the information necessary to install, operate, troubleshoot and maintain these thermal mass flow devices. The manual is organized in the following sections:

Section 1 Introduction

Section 2 Installation

Section 3 Operation

Section 4 Maintenance and Troubleshooting

Section 5 Product Description Code

Appendix A GF100 Series Gas Table

Appendix B GF100 Series Patents

Appendix C Essential Instructions

Warranty, Local Sales/Service Contact Information

It is recommended that this manual be read in its entirety before attempting to operate or repair these devices.

GF100 Series

1-3 Product Support References

Refer to www.BrooksInstrument.com for Brooks sales and service locations and to obtain other documents that support the GF100 Series. Those documents include:

- Brooks MultiFlo™ Configurator Quick Start Manual:
X-SW-MultiFlo-Config-QS-eng. part Number 541B167AAG

- Brooks GF100 Series data sheets:
DS-TMF-GF100-Series-MFC-eng
DS-TMF-GF135-Series-MFC-eng
DS-TMF-GF121-Series-MFC-eng
DS-DPT-EtherCAT-GF100-Series-eng

1-4 Notice and Caution Statements

Warning, caution and notice statements are located throughout this manual in the ANSI format. A WARNING statement indicates a potentially hazardous situation which, if not avoided, COULD result in death or serious injury. A CAUTION statement indicates a potentially hazardous situation which, if not avoided, MAY result in minor or moderate injury. It may also be used to alert against unsafe practices. A NOTICE statement describes specific information that requires special attention.

1-5 Product Warranty

Product warranty information can be found on the Back Cover of this Manual and on the Brooks website at www.BrooksInstrument.com. This information provides general warranty information, limitations, disclaimers, and applicable warranty periods according to product group.

1-6 How to Order a GF100 Series Device

Refer to Section 5.

1-7 Industry Standard References

Refer to Table 1-1.

1-8 GF100 Series Gas Table

Refer to Appendix A.

1-9 Glossary of Terms and Acronyms

Refer to Table 1-2

Table 1-1 Industry Standard References

Reference Number	Reference Description
MIL-STD-810	Method 514.4, Category 1, Transportation Requirement Method 516.4, Procedure 1, Functional Shock Test Requirement
SEMI E12	Standard temperature and pressure
SEMI E16	Guideline for determining and describing MFC leak rates
SEMI E17	Guideline for MFC transient characteristics tests
SEMI E18	Guideline for temperature specifications of the MFC
SEMI E27	Standard for MFC and MFM linearity
SEMI E28	Guideline for pressure specifications for the MFC
SEMI E52	Practice for referencing gases used in digital MFCs
SEMI E54	Sensor actuator network connections for DeviceNet
SEMI E56	Test method for determining accuracy, linearity, repeatability, short-term reproducibility, hystereses of thermal MFCs
SEMI E66	Test method for determining particle contribution by MFCs
SEMI E67	Test method for determining reliability of MFCs
SEMI E68	Test method for determining warm-up time of MFCs
SEMI E69	Test method for reproducibility and zero drift for thermal MFCs
SEMI E80	Test method for determining attitude sensitivity of MFCs
SEMI E16-90	Guidelines for determining and describing mass flow controllers leak rates
SEMI F19	Specification for the finish of the wetted surface of electro polished 216L stainless steel components
SEMI F20	Specifications for 316L stainless steel bar, extruded shapes, plate, and investment castings for components used in ultra-high purity semi manufacturing applications
SEMI F36	Guide for dimensions and connections of gas distribution components
SEMI F37	Method for determination of surface roughness parameters for gas distribution system components
SEMI F44	Guideline for standardization of machined stainless steel weld fittings
SEMI F45	Guideline for standardization of machined stainless steel reducing fittings
SEMI F47	Specifications for semiconductor processing equipment voltage sag immunity
SEMI S2	Environmental, Health and Safety Guidelines
SEMI S9	Dielectric testing
SEMI S10	Risk assessment
SEMI S12	Decontamination of fielded products
ETG.1000.2	Physical Layer service definition and protocol specification
ETG.1000.3	Data Link Layer service definition
ETG.1000.4	Data Link Layer protocol specification
ETG.1000.5	Application Layer service definition
ETG.1000.6	Application layer protocol specification
ETG.1020	EtherCAT Protocol Enhancements
ETG.2000	EtherCAT Slave Information
ETG.5001.1	Modular Device Profile - Part 1: General MDP Device Model
ETG.5003.1	Semiconductor Device profile - Part 1: Common Device Profile (CDP)
ETG.5003.2020	Specific Device Profile: Enhanced Mass Flow Controller
ETG.5003.2021	Specific Device Profile: Mass Flow Controller
ETG.5003.2022	Specific Device Profile: Mass Flow Meter
ETG.5003.2023	Specific Device Profile: Enhanced Mass Flow Meter

GF100 Series

Table 1-2 Terms and Acronyms

Term or Acronym	Definition
CSR	Customer Special Requirement
CVD	Chemical Vapor Deposition
DeviceNet	A 5-wire local network I/O communication device that employs a command/response communication protocol
DSP	Digital Signal Processor
EPI Epitaxy (EPI).	A process technology where a pure silicon crystalline structure is deposited or “grown” on a bare wafer, enabling a high-purity starting point for building the semiconductor device.
HBD	Horizontal Base Down
GF100 Series	Integrated Flow Controller
F.S.	Full Scale
LED	Light Emitting Diode
MFC	Mass Flow Controller
MultiFlo Configurator	I/O communication software package that configures gas and flow ranges
MultiFlo Technology	A physics-based calibration methodology that enables gas and flow range configuration within a defined standard configuration
PID	Proportional Integral Derivative Controller
PSIA	Pounds per Square Inch Absolute
PSID	Pounds per Square Inch Differential
PSIG	Pounds per Square Inch Gauge
PTI	Pressure Transient Insensitive. Reduces the effect of pressure fluctuations in gas flow. Applicable to GF125 only.
ROR	As pressure increases, flow increases at a pressure rate of rise, or ROR.
HC	Standard Configuration w/ Hastelloy® sensors (to reduce reaction to corrosive gases)
S.P.	Setpoint
Step Technology	Enables fast set point control through a high speed DSP and low volume drive circuit
VIU	Vertical mounting attitude with inlet side facing up

1-10 Description

Ultra Fast Response

The Brooks GF Series patented flow sensor combined with a high speed ARM processor and fast acting diaphragm-free valve assembly enables:

- Faster response and settling time for improved wafer throughput
- Ultra-fast 1-2 second etch step processing
- Reduced diverted gas consumption and associated abatement costs
- Time sensitive gas delivery steps in Atomic Layer Deposition
- User programmable start-up function for processes requiring a slow ramped gas turn-on or time critical transitions between flow rates

MultiFlo™ Gas and Range Configurability

The Brooks MultiFlo technology delivers exceptional improvement in process gas accuracy for linear and non-linear gases. This is achieved through advanced gas modeling and optimized through actual gas testing. Brooks MultiFlo™ allows the device to be quickly and easily configured for another gas and/or flow range without sacrificing accuracy or rangeability. Selecting a new gas automatically creates a new calibration curve, establishes optimized PID settings for dynamic control, automatically compensates for gas density effects, and ensures smooth overshoot-free transitions between flow rates with excellent steady-state stability. Brooks MultiFlo technology offers unparalleled flexibility. An extensive gas database is provided and a single device can be quickly programmed for thousands of different gas and flow range combinations. Process benefits achieved:

- Mass flow controller full scale full range can be rescaled down typically by a factor of 3:1 with no impact on accuracy, turndown or leak by specifications
- Optimum process and inventory flexibility resulting in dramatically reduced inventory costs
- Fewer configurations/bin sizes required to support many different processes
- Less down-time with rapid process recovery

MultiFlo™ Support References: Brooks MultiFlow Configurator Quick Start Guide (X-SW-MultiFlo-Config-QS-eng (Part Number: 541B167AAG))

MultiFlo™ Configurator Accessory Kits:

778Z010ZZZ Basic MultiFlo Configurator Kit

*Software, MultiFlo Configurator

A331710003 Cable Assembly 2.5mm

214F027AAA USB-RS485 Converter with DB-9 female

778Z011ZZZ Basic MultiFlo Configurator Kit w/Power Supply and Adapter Cables *Software, MultiFlo Configurator

A331710003 Cable Assembly 2.5mm

214F027AAA USB-RS485 Converter with DB-9 female

A332295001 Power Supply MFC

A332297002 Cable, Power, 9-Pin

A332297001 Cable, Power, DeviceNet

* MultiFlo Configurator Software is available on the Brooks Instrument website at: www.BrooksInstrument.com/MultiFlo

www.BrooksInstrument.com/Documentation&Downloads

Pressure Transient Insensitivity (PTI)— Included with all GF125 & GF135 models

Cost and space constraints are driving gas panel designers to remove point-of-use pressure regulators and pressure monitoring components from the process design and rely solely on the mass flow controller to accurately control the process under dynamic pressure conditions. The Brooks GF125 & GF135 (PTI) devices utilize a patented control algorithm that inverts the pressure signal, compares it to the pre-fluctuation signal and drives real-time valve position compensation to maintain stable flow. Enhanced pressure transient is achieved through faster sensing, quicker processing, and a reduction in internal dead-volume between the sensors and valve orifice.

GF101/121/126 based on the same technology and design as the low flow GF's (same sensor, same electronics, low power support)

- Smaller footprint than competitive MFC's
- Handles flow rates up to 300 slpm
- Metal seal for durability and high leak integrity
- Proprietary sensor technology
- Precise flow control with fast sub-1 second settling time
- 1% of reading accuracy
- Corrosion-resistant Hastelloy C-22 sensor tube

Optional Safe Delivery System (SDS)— GF120 model only

The Safe Delivery System (SDS) enhanced GF120 model is a state-of-the-art low pressure drop devices for the delivery of sub atmospheric safe delivery system gases used in Implant and Etch processes. The Brooks GF120 SDS models are available in full scale flow ranges 4 sccm -1 slpm.

Advanced Thermal Flow Measurement Sensor

Brooks proprietary highly corrosion resistant Hastelloy C-22 sensor with an enhanced sensor manufacturing and burn in process incorporates a unique orthogonal sensor mounting orientation to eliminate sensor drift caused by valve heating effects and eliminates thermal siphoning effects. This unique sensor configuration includes an optimized temperature profile for gases prone to thermal decomposition. This design results in:

- Enhanced signal to noise performance for improved accuracy at low set points
- Superior reproducibility at elevated temperature through new isothermal packaging and onboard conditioning electronics with ambient temperature sensing and compensation
- Improved long-term stability

High Purity Flow Path

The Brooks GF Series has an all metal, corrosion resistant Semi F20 compliant wetted flow path with highly corrosion resistant Hastelloy C-22 valve seat and jet orifice. The GF120, GF125 & GF135 devices are constructed with a 4 μ inch Ra max surface finish while the GF100 is constructed with a 10 μ inch Ra.

- Overall reduced surface area and un-swept volumes for faster dry-down during purge steps
- Long-term sensor and device stability for maximum yield and throughput

Extensive Mechanical Configurations

GF Series supports all metal seal/UHP industry gas connection interface standards for full OEM and process coverage.

- Downport 79.8mm and 92mm C-seal and W-seal on 1-1/8" and 1-1/2" bodies
- 124mm 4 VCR on 1-1/2" body



Figure 1-2 LCD Display

Enhanced Diagnostics and User Interface

The mass flow controller is one of the most complex and critical components in gas delivery systems. When dealing with ultra-high-purity gas distribution or highly toxic or corrosive gases, removing the mass flow controller to assess functionality should be the last resort. Brooks GF Series devices provide for in-line device evaluation and instantaneous troubleshooting through:

- Embedded self test routines and independent diagnostic/service port
- High visibility LCD display with easy accessible push button for local indication of Flow (%), Temperature ($^{\circ}$ C), Pressure (PSIA/kPa) and Network Address
- Zero button to easily re-zero the device during scheduled maintenance
- Rotatable display with a push button to enable improved readability based on how the MFC is mounted. Simply hold button down for at least 3 seconds to rotate display. This feature is standard for GF135 and GF101/GF121/GF126 and available for GF100/GF120/GF125.

This combination of features results in limiting service interruption and reduced downtime.

GF100 Series

Communication Interfaces

The GF100 Series supports analog 0-5 Vdc, RS485, DeviceNet™ and EtherCAT® communication protocols. Analog connections can be accessed via the DeviceNet or RS485 or Analog only connector options. DeviceNet and RS485 are multi-drop connections that allow a maximum of 64 devices for DeviceNet and 32 devices for RS485 to be connected on the same network. Brooks Instrument's DeviceNet profile has been certified by the ODVA™ (Open DeviceNet Vendor's Association). EtherCAT is an Ethernet based communications system known for its high cycle time and cost efficient cabling and master application solutions. The EtherCAT GF100 Series devices conform to the ETG.5003 Semiconductor Device Profile specification. A range of low profile adapter cables facilitate replacing previously installed devices eliminating the need to carry multiple devices of the same gas/range but different electrical connectors.

1-11 Specifications for GF100 Series Devices**⚠ WARNING**

Do not operate this instrument in excess of the specifications listed below. Failure to heed this warning can result in serious personal injury and/or damage to the equipment.

⚠ CAUTION

It is the user's responsibility to select and approve all materials of construction. Careful attention to metallurgy, engineered materials and elastomeric materials is critical to safe operation.

See Table 1-3 for specifications for standard GF100 Series.

See Table 1-4 for specifications for the Safe Delivery System (SDS) GF120 Series.

See Table 1-5 for specifications for standard GF100 Series-EtherCAT

See Table 1-6 for specifications for the GF135 Series.

See Table 1-7 for specifications for the GF121 Series.

See Table 1-8 for specifications for the GF121 Series-EtherCAT

See Figure 1-3 for dimensions for the GF100 Series.

See Figures 1-4 & 1-5 for dimensions for the GF135 Series.

See Figure 1-6 for dimensions for the GF121 Series.

See Figure 1-7 for dimensions for the GF100/GF121 Series-EtherCAT

Table 1-3 Specifications for Standard GF100/GF120/GF125 Series

Performance	GF100	GF120	GF125
Full Scale Flow Range (N ₂ Eq.)	3 sccm to 55 slm		
Flow Accuracy	±1% S.P. > 35-100%, ±0.35% F.S. 2-35%		
Repeatability & Reproducibility	< ± 0.15% S.P.		
Linearity	± 0.5% F.S. (included in accuracy)		
Response Time (Settling Time) Normally Closed Valve	< 1 sec	700ms	300ms (3-860 sccm N ₂ Eq.) 400ms (861-7200 sccm N ₂ Eq.) 500ms (7201-30000 sccm N ₂ Eq.) <700ms (30001-55000 sccm N ₂ Eq.)
Normally Open Valve	<1.5 sec		
Pressure Insensitivity	Not Applicable		< 5% SP up to 5 psi/sec upstream press. spike
Control Range	2-100% (Normally Closed Valve)	3-100% (Normally Open Valve)	
MultiFlo	standard		
#of Bins	11 bins		
Valve Shut Down (N.C. Valve)	< 1% of F.S.		
Valve Shut Down (N.O. Valve)	2% of F.S.		
Zero Stability	< ± 0.5% F.S. per year		
Temperature Coefficient	Span: 0.05% S.P. per °C, Zero: 0.005% F.S. per °C		
Ratings			
Operating Temperature Range	10-50°C		
Differential Pressure Range*	3-860 sccm = 7-45 psid, 861- 7200 sccm = 10-45 psid, 7201-55000 sccm = 15-45 psid *Argon gas applications require an additional 10 psid differential pressure. Low vapor pressure gases require an inlet pressure of > 100 Torr, with vacuum on outlet (example SiCl ₄). Contact Brooks Technical Support for more information.		
Maximum Operating Pressure	500 psia max	100 psia max	
Leak Integrity (external)	1x10 ⁻¹⁰ atm. cc/sec He		
Mechanical			
Valve Type	Normally Closed Normally Open Meter (no valve)		
Wetted Materials	GF100: SEMI F20 HP Compliant, 316L VIM/VAR, Hastelloy C-22, 316L Stainless Steel, 304 Stainless Steel, KM-45 GF120/GF125: SEMI F20 UHP Compliant, 316L VIM/VAR, Hastelloy C-22, 316L Stainless Steel, 304 Stainless Steel, KM-45		
Surface Finish	10µ inch Ra	4µ inch Ra (0.1 µm Ra)	
Diagnostics & Display			
Status Lights	MFC Health, Network Status		
Alarms	Control Valve Output, Network Interruption		
Display Type Viewing Angle / Viewing Distance Units Displayed / Resolution	Top Mount Integrated LCD Fixed / 10 feet Flow (%), Temp. (°C), Pressure (psia, kPa) / 0.1 (unit)		
Electrical			
Electrical Connection	RS485/Analog via 9-Pin "D" connector, DeviceNet™ via 5-Pin "M12" connector		
Digital Communication	RS485+ (model specific), DeviceNet (model specific), RS485 Diagnostic Port (all models)		
Diagnostic /Service Port	RS485 via 2.5mm jack		
Power Supply/Consumption	DeviceNet: 545mA max. @ +11-25 Vdc., 250mA max. @ 24Vdc RS485/Analog: 6 Watts max @ ±15Vdc. (±10%) or +24 Vdc (±10%)		
Compliance			
EMC	EC Directive 2004/108/EC CE: EN61326: 2006 (FCC Part 15 & Canada IC-subset of CE testing)		
Environmental Compliance	RoHS Directive (2011/65/EU) REACH Directive EC 1907/2006		

NOTE: See the following Safe Delivery System (SDS) section for optional detailed specifications

GF100 Series

Table 1-4 Specifications for Safe Delivery System (SDS) GF120 Series

Performance	GF120XSL	GF120XSD
Full Scale Flow Range (N ₂ Eq.)	4 - 25 sccm	>25 to 1 slpm
Gases Supported	AsH ₃ , PH ₃ , BF ₃ , SiF ₄ , Ar, Xe, N ₂ O, N ₂ , GeF ₄ , AsF ₅ , PF ₃ , H ₂ Se, HMDSO, HMDSN, H ₂ O***	
MultiFlo Programmable	Not Configurable	
Flow Accuracy	+/-1% S.P. ≥35% F.S. +/-0.35% F.S. <35% F.S.	
Repeatability & Reproducibility	<+/- 0.15% S.P.	
Zero Stability	<=0.6% F.S. per year	
Settling Time (to within ±2% F.S.)	< 3 sec	
Warm Up Time	minimum of 30 minutes	
Leak Integrity	1X10 ⁻¹¹ atm. cc/sec He	
Valve Shut Down (Leaky by)	<1% F.S.	

Operating Conditions	GF120XSD	GF120XSL
Minimum Operating Inlet Pressure*	4 to 20 sccm ≤ 10 Torr >20 to 50 sccm ≤ 20 Torr >50 sccm to 1 slpm ≤ 50 Torr	
Maximum Pressure	500 psia max	
Pressure Insensitivity	Not Available	
Differential Pressure**	10 Torr-30 psid typical (1.33-207 kPa typical)	
Valve Configuration	Normally Closed	
Ambient Temperature Range	10°C-50°C	
Zero Temperature Coefficient	Span: 0.05% SP per °C, Zero: 0.005% F.S. per °C	

*Performance at minimum inlet pressure will be gas and flow range dependent. Consult Technical Support for details.

**Typical pressure drop. Actual pressure drop will be gas and flow dependent. Consult Technical Support for details.

***Consult factory for other gases.

Table 1-5 Specifications for GF100/GF120/GF125 Series with EtherCAT Communications

Performance	GF100	GF120	GF125	GF120XSL	GF120XSD
Full Scale Flow Range	3 sccm to 55 slm			4 sccm to 25 sccm	>25 sccm to 1 slpm
Flow Accuracy	±1% S.P. > 20-100%; ±0.2% F.S. 2-20%			±1% S.P. 35-100%; ±0.35% F.S. 2-35%	
Repeatability & Reproducibility	< ± 0.15% S.P.				
Flow Settling Time (NC Valve)	< 1 sec	700ms	300ms (3-860 sccm N2 Eq.) 400ms (861-7200 sccm N2 Eq.) 500ms (7201-30000 sccm N2 Eq.) <700ms (30001-55000 sccm N2 Eq.)	< 3 sec	
Flow Settling Time (NO Valve)	<1.5 sec			-----	
Pressure Insensitivity	Not Applicable		< 1% S.P. up to 5 psi/sec upstream press. spike	-----	
Control Range	2-100% (Normally Closed Valve) 3-100% (Normally Open Valve)			2-100% (Normally Closed Valve)	
MultiFlo	Standard			-----	
#of Bins	11 bins			-----	
Valve Shut Down (N.C. Valve)	0.15% of F.S.			<1% of F.S.	
Valve Shut Down (N.O. Valve)	2% of F.S.			-----	
Zero Stability	< ± 0.15% F.S. per year			< ± 0.6% F.S. per year	
Temperature Coefficient	Zero: 0.005% F.S. per °C			Zero 0.005% of F.S. per °C	

Ratings

Operating Temperature Range	10-50°C				
Differential Pressure Range*	3-860 sccm = 7-45 psid 861- 7200 sccm = 10-45 psid 7201-55000 sccm = 15-45 psid			10 Torr - 30 psid typical For more details consult factory	
Maximum Operating Pressure	500 psia max		100 psia max	up to 500 psia max	
Leak Integrity (external)	1x10 ⁻¹⁰ atm. cc/sec He				

Mechanical

Valve Type	Normally Closed Normally Open Meter (no valve)			Normally Closed	
Wetted Materials	SEMI F20 HP Compliant, 316L VIMVAR, Hastelloy C-22, 316L Stainless Steel, 304 Stainless Steel, KM-45				
Surface Finish	10µ inch Ra	5µ inch Ra		5µ inch Ra	

Diagnostics & Display

Status Lights	Run, Error, Power, Network Status				
Alarms	Control Valve Output, Network Interruption, Temperature High/Low, Pressure High/Low, Power Surge/Sag				
Display Type	Top Mount Integrated LCD				
Viewing Angle / Viewing Distance	Rotatable / 10 feet				
Units Displayed / Resolution	Flow (%), Temp. (°C), Pressure (psia, kPa) / 0.1 (unit)				

Electrical

Electrical Connection	Power via 5-pin M8 Connector, EtherCAT via RJ45 jacks				
Digital Communication	EtherCAT				
Diagnostic /Service Port	Micro-USB				
Power Supply/Consumption	320 mA max. @ 18-30 Vdc, 230 mA max. @ 24 Vdc (under typical operating conditions)				

Compliance

EMC	EMC Directive 2014/30/EU Evaluation Standard EN61326-1:2013				
Environmental Compliance	RoHS Directive (2011/65/EU) REACH Directive EC (1907/2006)				

*Argon gas applications require an additional 10 psid differential pressure. Low vapor pressure gases require an inlet pressure of > 100 Torr, with vacuum on outlet (example SiCl4). Contact Brooks Technical Support for more information.

GF100 Series

Table 1-6 Specifications for GF135 Series

Performance

Full Scale Flow Range:	3 sccm to 5 slm (N2 Eq.)
Gasses Supported:	N2, O2, Ar, H2, SF6, NH3, CO2, Cl2, HBr, NF3, CF4, CH4, CH3F, CH2F2, SiCl4 (@ 100 Torr), C4F6-q (@ 800 Torr), C4F8 (@ 1200 Torr), N2O, CHF3, SiH2Cl2, C5F8, He
Flow Accuracy:	+/-1.0% S.P. (10-100% F.S.), +/-1% S.P. plus +/-0.04% F.S. (2-10% F.S.)
Repeatability & Reproducibility:	< +/- 0.15% S.P.
Linearity:	Included in accuracy
Settling Time (to within +/-2% FS):	<300ms (<860 sccm N2 Equivalent), <400ms (861-5000 sccm N2 Equivalent)
Pressure Insensitivity:	< 1% S.P. up to 5 psi/sec upstream press. spike
Control Range:	1-100%
Valve Shut Down:	< 0.5% of F.S. N2
Zero Stability:	< +/- 0.5% F.S. per year
Temperature Coefficient:	Span: 0.05% setpoint per °C, Zero: 0.005% F.S. per °C
Rate-of-Decay Performance:	(ROD by default is disabled/off. It should not be enabled until after MFC is installed and properly commissioned)
Flow Rate:	Maximum flow rate for which an ROD measurement can be obtained is 800 sccm
Temperature Sensitivity:	+/- 0.04% S.P./Deg C
Pressure Sensitivity:	+/- 0.04% F.S./psi
Minimum Detectable Change from Commissioning Baseline:	Zero Drift: +/- 0.02% F.S. Valve Leak: +0.1% F.S. Repeatability: +/- 0.3% S.P. (SiCl4 +/- 0.5% from 5-100% S.P. up to 100 sccm flow)

Ratings

Operating Temperature Range:	10-50°C
Differential Pressure Range**:	3-860 sccm = 7-45 psid, 861- 5000 sccm = 10-45 psid **Typical pressure drop. Actual pressure drop will be gas and flow dependent. Argon gas applications require higher differential pressure. Low vapor pressure gases require an inlet pressure of > 100 Torr, with vacuum on outlet (example SiCl4). Contact Brooks Technical Support for more information.
Maximum Operating Pressure:	100 psia max
Pneumatic Valve Operating Pressure:	43.5 psia - 72.5 psia
Leak Integrity (external):	1x10 ⁻¹⁰ atm. cc/sec He

Mechanical

Valve Type:	Normally Closed
Wetted Materials:	SEMI F20 UHP Compliant 316L VIM/VAR, Hastelloy C-22,316L Stainless Steel, 304 Stainless Steel, KM-45
Surface Finish:	4µ inch Ra (0.1 µm Ra)

Diagnostics & Display

Status Lights:	MFC Health, Network Status
Alarms:	Sensor Output, Control Valve Output, Over Temperature, Power Surge/Sag, Network Interruption, Sensor Drift, Flow Error, Valve Leak
Display Type:	Top Mount Electronically Rotatable Integrated LCD
Viewing Distance:	Fixed / 10 feet
Units Displayed / Resolution:	Flow (%), Temp. (°C), Pressure (psia, kPa) / 0.1 (unit)

Electrical

Electrical Connection:	Analog/RS-485 via 9-Pin "D" connector, DeviceNet via 5-Pin "M12" connector
Digital Communication:	RS485+ (model specific), DeviceNet (model specific), RS485 Diagnostic Port (all models)
Diagnostic / Service Port:	RS485 via 2.5 mm jack
Power Supply/Consumption:	DeviceNet: +11-25 Vdc., 545 mA max. @ 11 Vdc., 250 mA (max.) @ 24 Vdc., Analog /RS485: +/-15 Vdc. (+10%), 6 Watts (max) or +24 Vdc +/-10%

Compliance

EMC	EC Directive 2004/108/EC CE: EN61326: 2006 (FCC Part 15 & Canada IC-subset of CE testing)
Environmental Compliance	RoHS Directive 2011/65/2006 Reach Directive EC 1907/2006

Table 1-7 Specifications for GF101/GF121/GF126 Series

Performance	GF101	GF121	GF126
Full Scale Flow Range (N ₂ Eq.)	55 to 300 slm		
Flow Accuracy	±1% S.P. > 35-100%, ±0.35% F.S. 2-35%		
Repeatability & Reproducibility	< ± 0.15% S.P.		
Linearity	± 0.5% F.S. (included in accuracy)		
Response Time (Settling Time) Normally Closed Valve	< 1 sec		
Pressure Transducer			Ability to measure inlet pressure
Control Range	5-100% (Normally Closed Valve)		
MultiFlo	Standard (All typical high flow rate process gases & mixtures supported)		
# of Bins	4 Bins		
Control Range	5-100% (Normally Closed Valve)		
Valve Shut Down (N.C. Valve)	< 2% of F.S. @ 30 N ₂ psig/atm out		
Zero Stability	< ± 0.5% F.S. per year		
Temperature Coefficient	Span: 0.05% S.P. per °C, Zero: 0.005% F.S. per °C		
Ratings			
Operating Temperature Range	10-50°C		
Differential Pressure Range	30-90 psid		
Maximum Operating Pressure	Controller: 75 psig / Meter: 150 psig		
Leak Integrity (external)	1x10 ⁻¹⁰ atm. cc/sec He		
Mechanical			
Valve Type	Normally Closed Meter (no valve)		
Wetted Materials	GF101: SEMI F20 HP Compliant, 316L VIMVAR, Hastelloy C-22, 316L Stainless Steel, 304 Stainless Steel, KM-45 GF121/GF126: SEMI F20 UHP Compliant, 316L VIMVAR, Hastelloy C-22, 316L Stainless Steel, 304 Stainless Steel, KM-45		
Surface Finish	10µ inch Ra	5µ inch Ra (0.1 µm Ra)	
Diagnostics & Display			
Status Lights	MFC Health, Network Status		
Alarms	Control Valve Output, Network Interruption		
Display Type Viewing Angle / Viewing Distance Units Displayed / Resolution	Top Mount Integrated LCD Fixed / 10 feet Flow (%), Temp. (°C), Pressure (psia, kPa) / 0.1 (unit)		
Electrical			
Electrical Connection	RS485/Analog via 9-Pin "D" connector, DeviceNet™ via 5-Pin "M12" connector		
Digital Communication	RS485+ (model specific), DeviceNet (model specific), RS485 Diagnostic Port (all models)		
Diagnostic /Service Port	RS485 via 2.5mm jack		
Power Supply/Consumption	DeviceNet: 545 mA max. @ +11-25 Vdc., 250mA max. @ 24 Vdc (Under typical operating conditions) RS485/Analog: 6 Watts max @ ±15 Vdc. (±10%) (Under typical operating conditions)		
Compliance			
EMC	EC Directive 2004/108/EC CE: EN61326: 2006 (FCC Part 15 & Canada IC-subset of CE testing)		
Environmental Compliance	RoHS Directive (2011/65/EU) REACH Directive EC 1907/2006		

GF100 Series

Table 1-8 Specifications for GF101/GF121/GF126 Series with EtherCAT Communications

Performance	GF101	GF121	GF126
Full Scale Flow Range	55 slm to 300 slm		
Flow Accuracy	±1% S.P. > 35-100%; ±0.35% F.S. 2-35%		
Repeatability & Reproducibility	< ± 0.15% S.P.		
Response Time/Settling Time (NC Valve)	< 1 sec		
Pressure Insensitivity	Not Applicable		Ability to measure inlet pressure
Control Range	5-100% (Normally Closed Valve)		
MultiFlo	Standard		
#of Bins	4 bins		
Valve Shut Down (N.C. Valve)	<2% of F.S. @30 N2 psig/atm out		
Zero Stability	< ± 0.15% F.S. per year		
Temperature Coefficient	Zero: 0.005% F.S. per °C		

Ratings

Operating Temperature Range	10-50°C
Differential Pressure Range	30-90 psid
Maximum Operating Pressure	Controller: 75 psig Meter: 150 psig
Leak Integrity (external)	1x10 ⁻¹⁰ atm. cc/sec He

Mechanical

Valve Type	Normally Closed Meter (no valve)	
Wetted Materials	SEMI F20 HP Compliant, 316L VIMVAR, Hastelloy C-22, 316L Stainless Steel, 304 Stainless Steel, KM-45	
Surface Finish	10μ inch Ra	5μ inch Ra

Diagnostics & Display

Status Lights	Run, Error, Power, Network Status
Alarms	Control Valve Output, Network Interruption, Temperature High/Low, Pressure High/Low, Power Surge/Sag
Display Type	Top Mount Integrated LCD
Viewing Angle / Viewing Distance	Rotatable / 10 feet
Units Displayed / Resolution	Flow (%), Temp. (°C), Pressure (psia, kPa) / 0.1 (unit)

Electrical

Electrical Connection	Power via 5-pin M8 Connector, EtherCAT via RJ45 jacks
Digital Communication	EtherCAT
Diagnostic /Service Port	Micro-USB
Power Supply/Consumption	320 mA max. @ 18-30 Vdc, 230 mA max. @ 24 Vdc (under typical operating conditions)

Compliance

EMC	EMC Directive 2014/30/EU Evaluation Standard EN61326-1:2013
Environmental Compliance	RoHS Directive (2011/65/EU)
	REACH Directive EC (1907/2006)

Downport Configurations

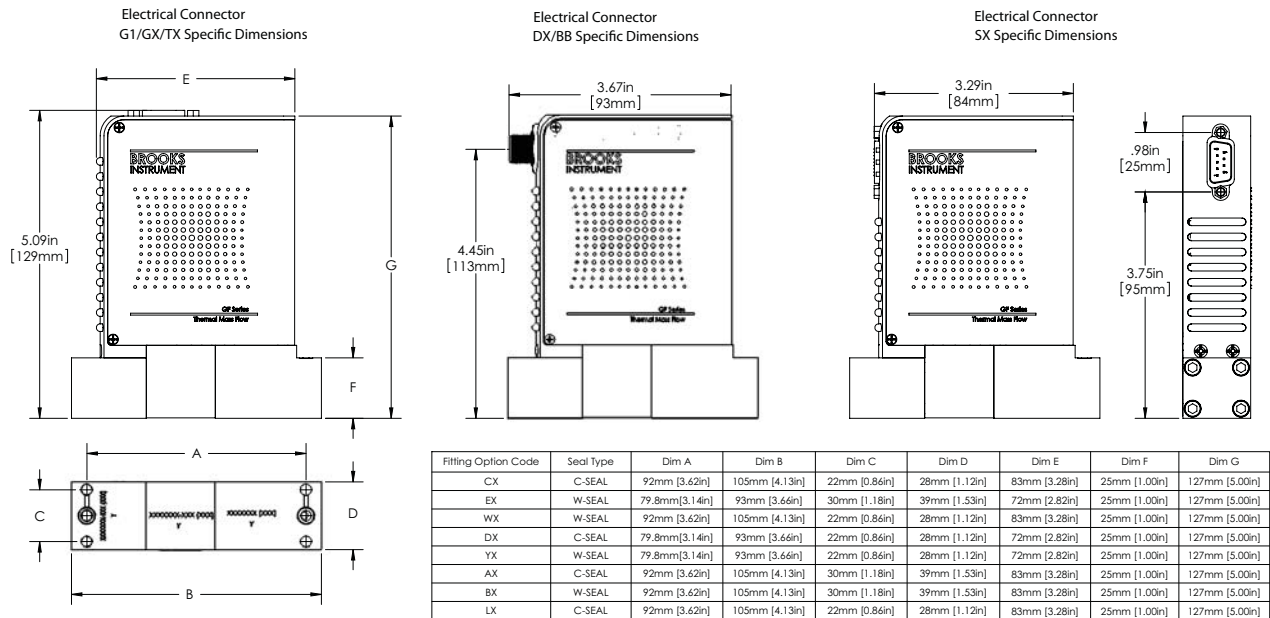

VCR Configurations

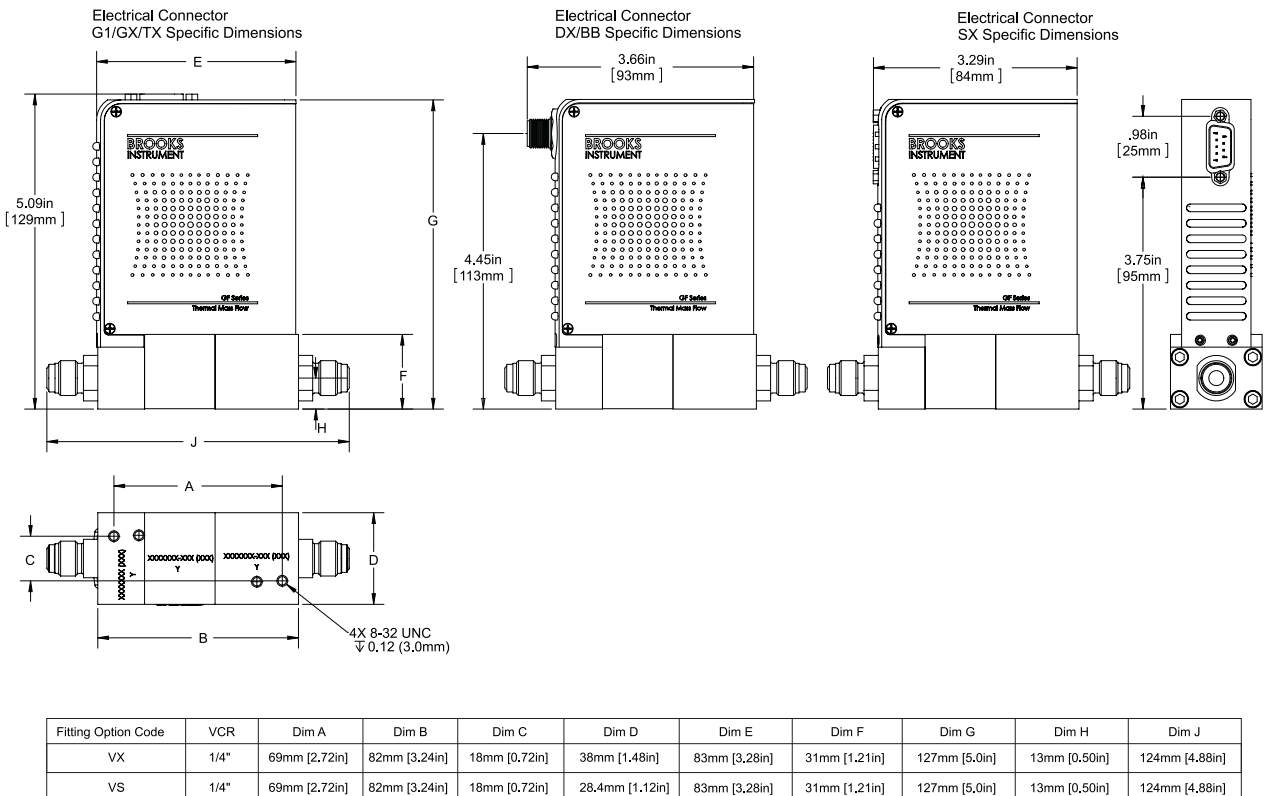
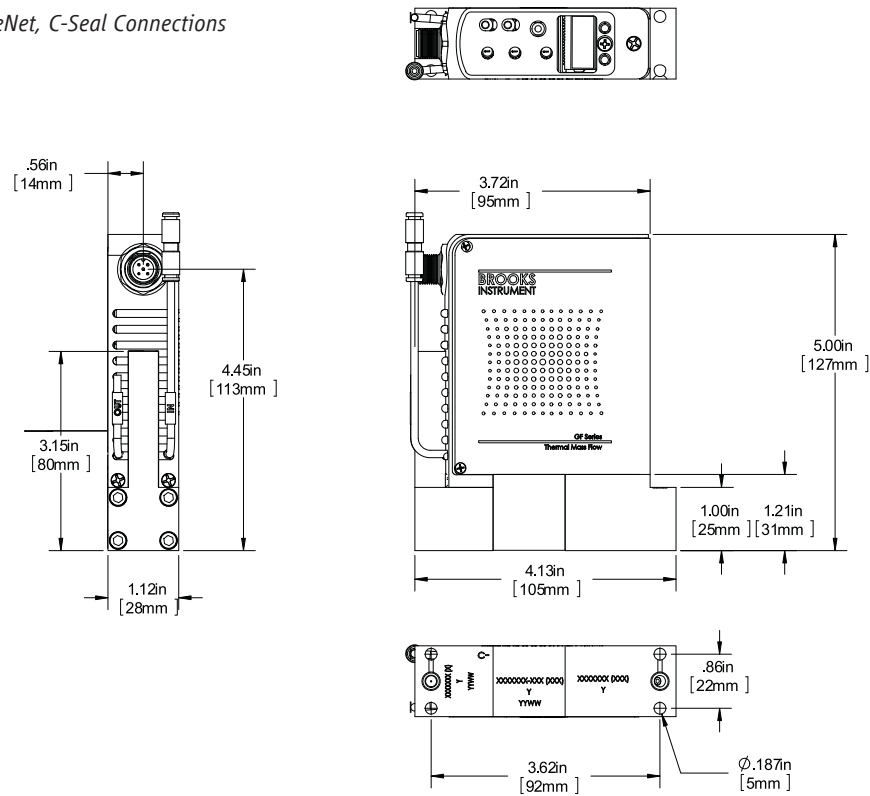

Figure 1-3 Dimensions - GF100/GF120/GF125 Series

GF100 Series

Model GF135, DeviceNet, C-Seal Connections



Model GF135, DeviceNet, VCR Connections

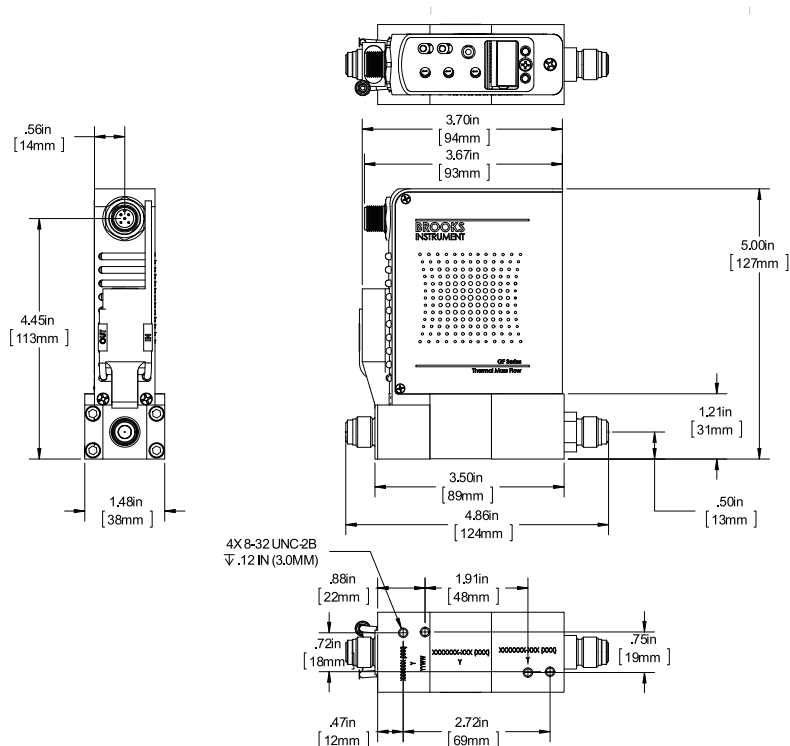

Model GF135, RS485, C-Seal Connections

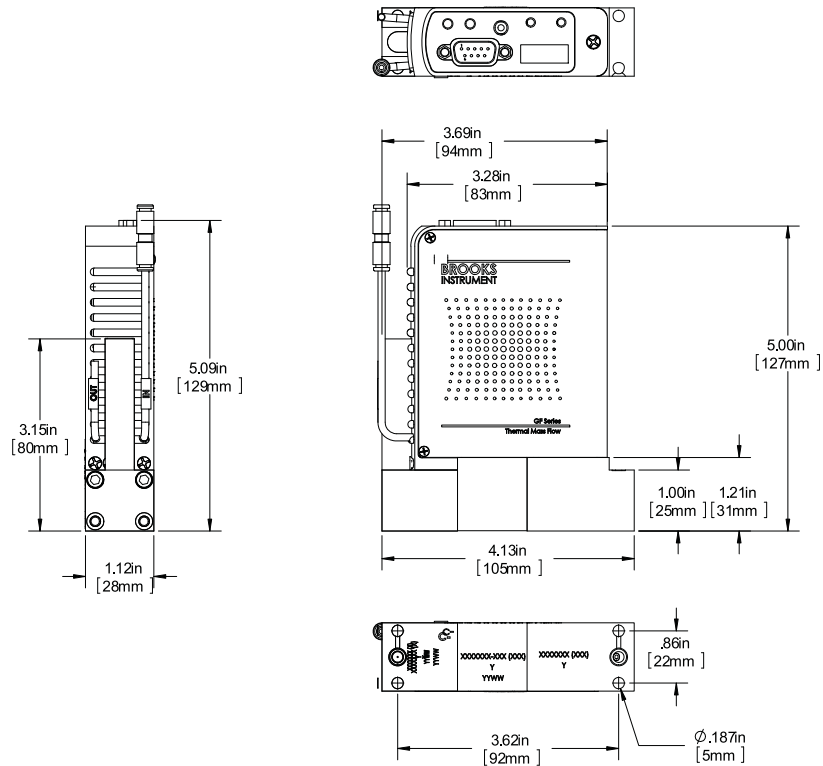

Model GF135, RS485, VCR Connections

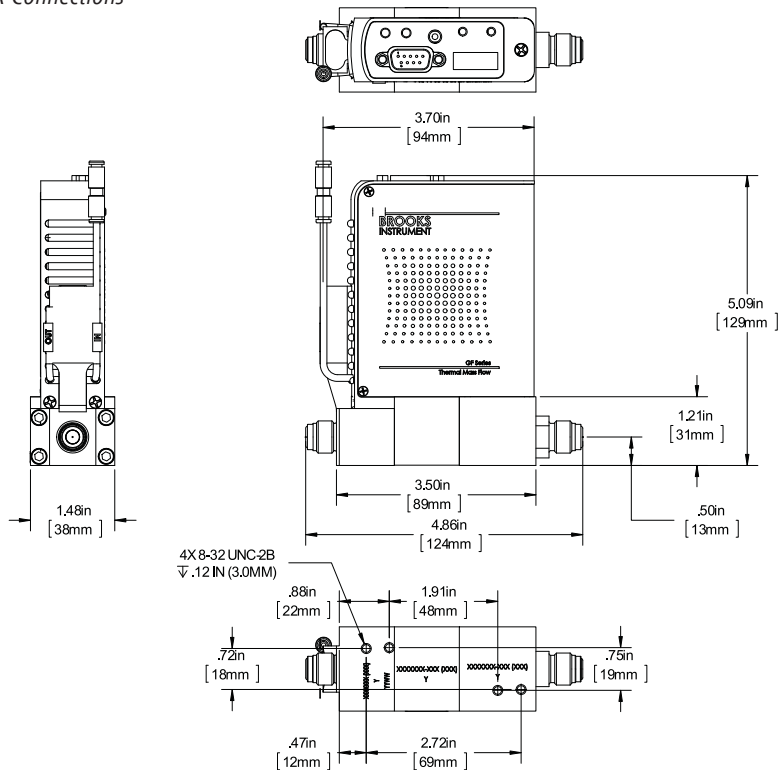
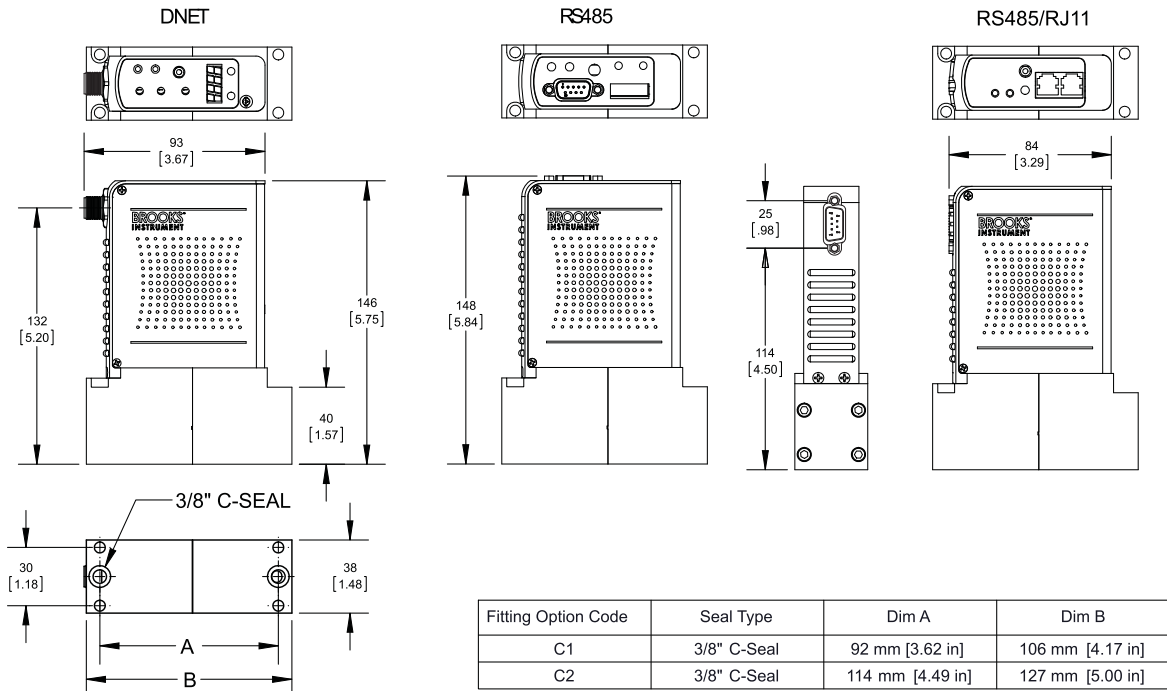

Figure 1-5 Dimensions - GF135 Series, RS485

GF100 Series

C-Seal Configurations



VCR Configurations

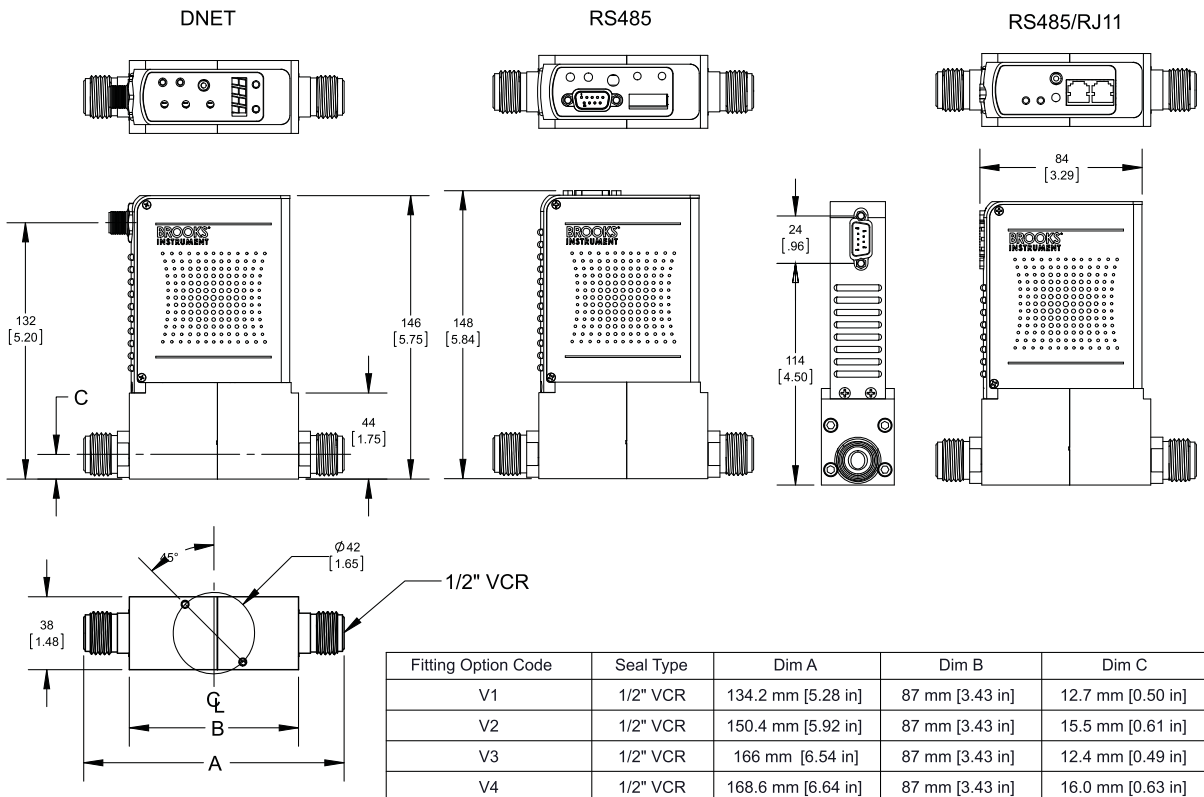

EtherCAT, Downport Configurations

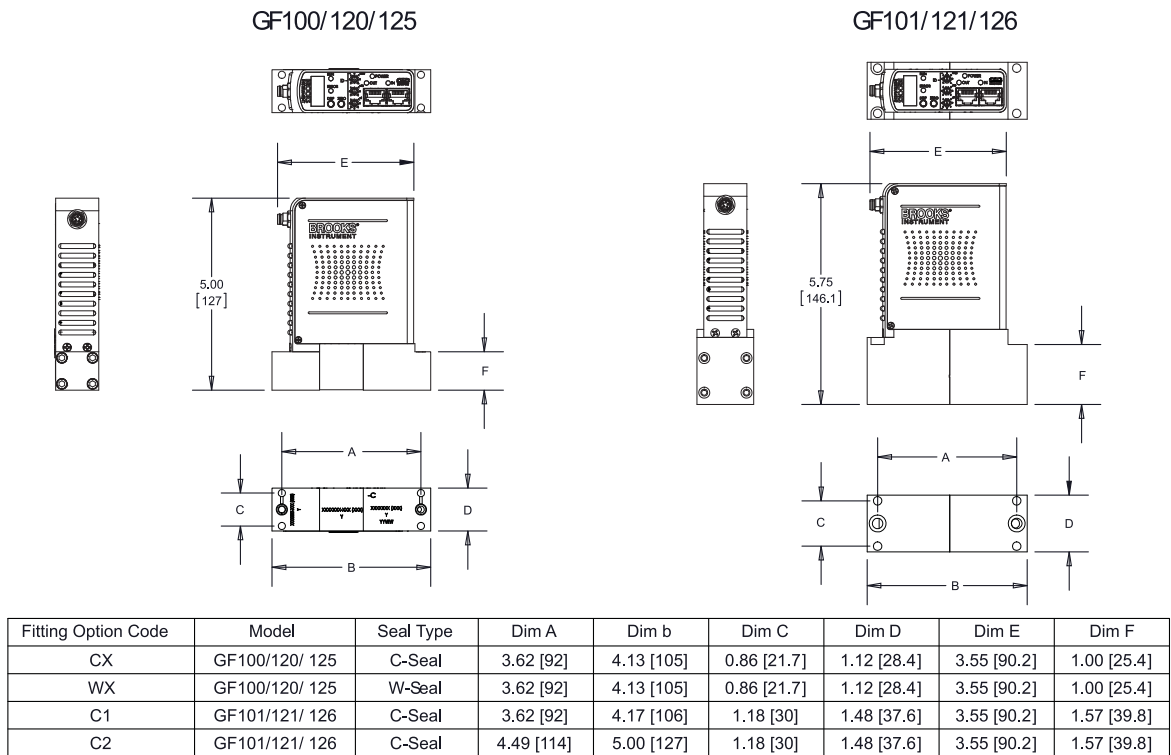

NOTE: [] ALTERNATE DIMENSION UNITS ARE FOR REFERENCE ONLY.

EtherCAT, VCR Configurations

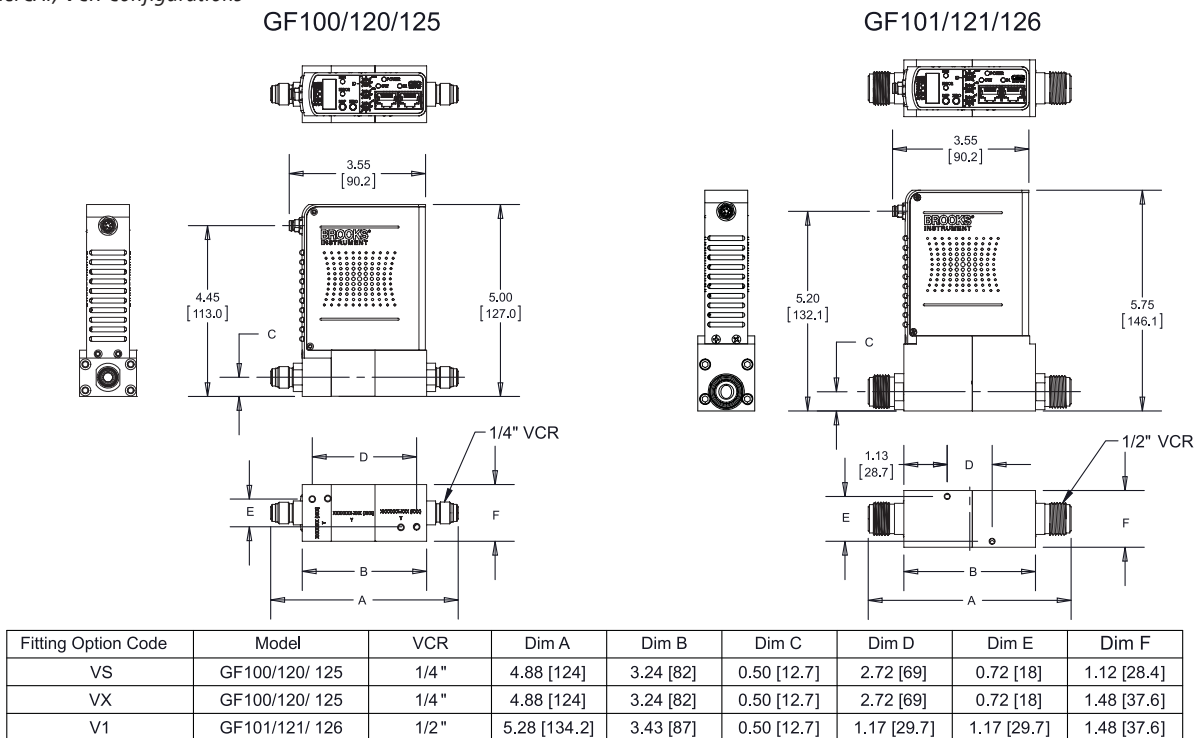

NOTE: [] ALTERNATE DIMENSION UNITS ARE FOR REFERENCE ONLY.

Figure 1-7 Dimensions - GF100/GF120/GF125, GF101/GF121/GF126 Series with EtherCAT Communications

*THIS PAGE WAS
INTENTIONALLY
LEFT BLANK*

2-1 General

This section provides installation instructions for the Brooks GF100 Series Thermal Mass Flow Devices. The installation process consists of purging the gas supply line prior to installation, unpacking and inspecting the device, connecting the device to the gas supply line and testing for leaks.

2-2 Receipt of Equipment

When the equipment is received, the outside packing case should be checked for damage incurred during shipment. If the packing case is damaged, the local carrier should be notified at once regarding his liability. A report should be submitted to the nearest Brooks Instrument location listed on the Global Service Network page on our website: BrooksInstrument.com/GlobalSupportCenters
This device has been assembled, calibrated, and double-vacuum bagged in a Class 100 clean room. In your semi-clean area, remove the outer bag only. Pass the device into your clean area. Remove the second clean room compatible bag only when the device is ready to be tested and/or installed in your clean system.

2-3 Recommended Storage Practice

If intermediate or long-term storage of the device is required, it is recommended that it be stored in accordance with the following conditions:

- Within the original shipping container.
- Ambient temperature 21°C (70°F) nominal, 32°C (90°F) maximum, 7°C (45°F) minimum.
- Relative humidity 45% nominal, 60% maximum, 25% minimum.

2-4 Return Shipment

Prior to returning any instrument to the factory for any reason, visit our website for instructions on how to obtain a Return Materials Authorization Number (RMA #) and complete a Decontamination Statement to accompany it: BrooksInstrument.com/Service. All instruments returned to Brooks also require a Material Safety Data Sheet (MSDS) for the fluid(s) used in the instrument. Failure to provide this information will delay processing of the instrument.
Instrument must have been purged in accordance with the following:

WARNING

Before returning the device, purge thoroughly with a dry inert gas such as Nitrogen before disconnecting process connections. Failure to correctly purge the instrument could result in fire, explosion or death. Corrosion or contamination may occur upon exposure to air.

GF100 Series

2-5 Transit Precautions

To safeguard against damage during transit, transport the device to the installation site in the same container used for transportation from the factory, if circumstances permit.

2-6 Removal from Storage

Upon removal of the device from storage, a visual inspection should be conducted to verify its "as-received" condition. If the device has been subject to storage conditions in excess of those recommended (refer to "2-3 Recommended Storage Practice" on p. 2-1), it should be subjected to a pneumatic pressure test in accordance with applicable vessel codes. To maintain a devices ultraclean integrity, this service should be performed by the factory or one of the certified service centers.

2-7 Gas Connections

Prior to installation, ensure that all piping is clean and free from obstructions. Install piping in such a manner that permits easy access to the device if removal becomes necessary.

2-8 In-Line Filter

It is recommended that an in-line filter be installed upstream from the device to prevent the possibility of any foreign material entering the flow sensor or control valve. The filtering element should be replaced periodically or ultrasonically cleaned.

2-9 Mechanical Installation**⚠ CAUTION**

When installing the Mass Flow Controller or Meter, care should be taken that no foreign materials enter the inlet or outlet of the instrument. Do not remove the protective end caps until the time of installation.

The recommended installation procedure guidelines are as follows:

- The device should be located in a clean, dry atmosphere relatively free from shock and vibration.
- Leave sufficient room for access to the user interface, display and MAC ID and baud rate switches (if equipped) at the top of the device.
- Install the device in such a manner that permits easy purge and removal if the device requires servicing.

⚠ CAUTION

When used with a reactive (sometimes toxic) gas, contamination or corrosion may occur as a result of plumbing leaks or improper purging. Plumbing should be checked carefully for leaks and the instrument purged with clean, dry N₂ before use.

The GF100 Series is equipped with PTI technology, which reduces the effect of pressure fluctuations on gas flow. In PTI technology, a signal from an integrated pressure transducer is combined with the standard thermal sensor output. The combined signals allow precise and stable flow, even when the line pressure is fluctuating.

The GF100 Series also utilizes MultiFlo® technology that allows the user to configure standard configurations ("SHs") or "blanks" for a variety of pure gases and mixtures. As a result, MultiFlo® technology enables the user to reduce unique inventory requirements.

2-10 Flow Controller Installation Arrangement

Typical gas supply arrangements are shown in Figures 2-1 and 2-2. GF100's are often arranged inside a gas panel. Configure standard configurations ("SHs") or "blanks" for a variety of pure gases and mixtures. As a result, MultiFlo technology enables the user to reduce unique inventory requirements.

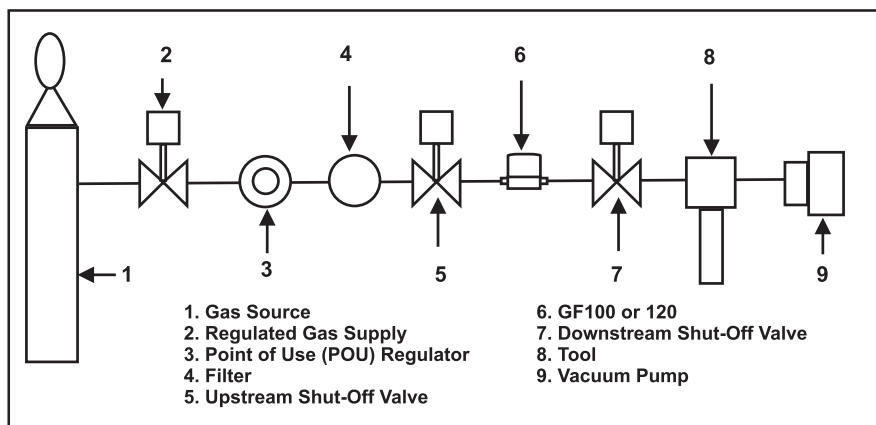

Figure 2-1 Typical Gas Supply Arrangement with non-PTI MFC

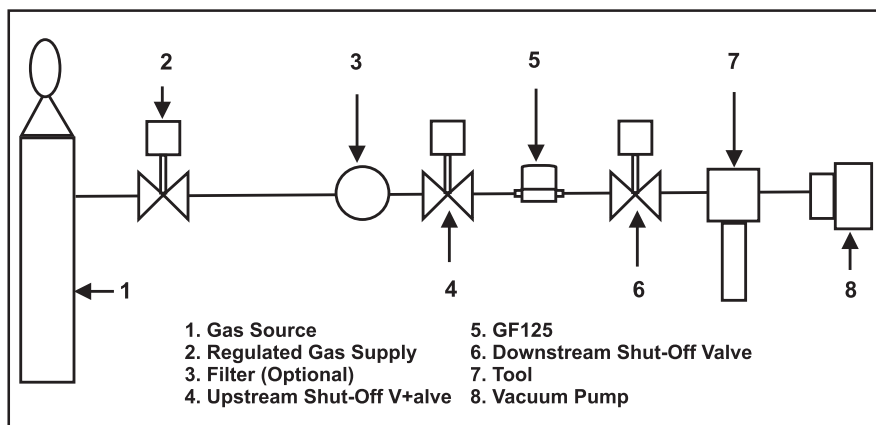

Figure 2-2 Typical Gas Supply Arrangement with PTI MFC

GF100 Series

2-11 Purge the Gas Supply Line Before GF100 Series Installation

⚠ CAUTION

For additional safety, it is recommended to close the two valves between the charged gas line and the GF100 Series to be installed. See Figures 2-1 and 2-2 for more details.

⚠ NOTICE

It is recommended to archive service and calibration documentation for the GF100 Series in order to determine the contamination state of each gas line and to assist service personnel.

⚠ CAUTION

DO NOT remove the shipping caps covering the inlet/outlet for VCR fittings, or **DO NOT** remove the blue tape on the bottom of the device for downported fittings before the GF100 Series is actually being installed. Failure to comply will introduce contaminants into the GF100 Series.

Before operating the GF100 Series, the gas supply line must be completely purged with nitrogen or argon to ensure the line is free from toxic or flammable gases, contaminants, moisture, and oxygen. The purge gas must be free of moisture and oxygen to less than 100 ppb. Purge the gas lines as follows or in accordance to prescribed company and safety procedures.

1. Shut off the process gas supply valve(s) upstream of the GF100 Series. If such a valve is not available, shut the valve on the gas panel. Tag the valve at this point to prevent accidental re-exposure of the process gas to the gas line.
2. Cycle purge the gas line with dry nitrogen or argon to fully flush out the process gas. Cycle purging consists of evacuating to a low pressure adequate to induce out-gassing and then purging to remove adhered moisture and oxygen. If a toxic or reactive gas is present and a clogged GF100 Series is suspected, then proceed with caution. Pump down and purge the GF100 Series from both downstream and upstream lines. If check valves are present in the gas line, both pumping down and purging are required. Pumping down without purging is inadequate. If a good vacuum source is not available, the GF100 Series can be decontaminated by purge only.
3. Repeat the purge cycle several times within 2-4 hours to complete the cleaning. For toxic and corrosive gasses, it is recommended to use 100-120 cycles.

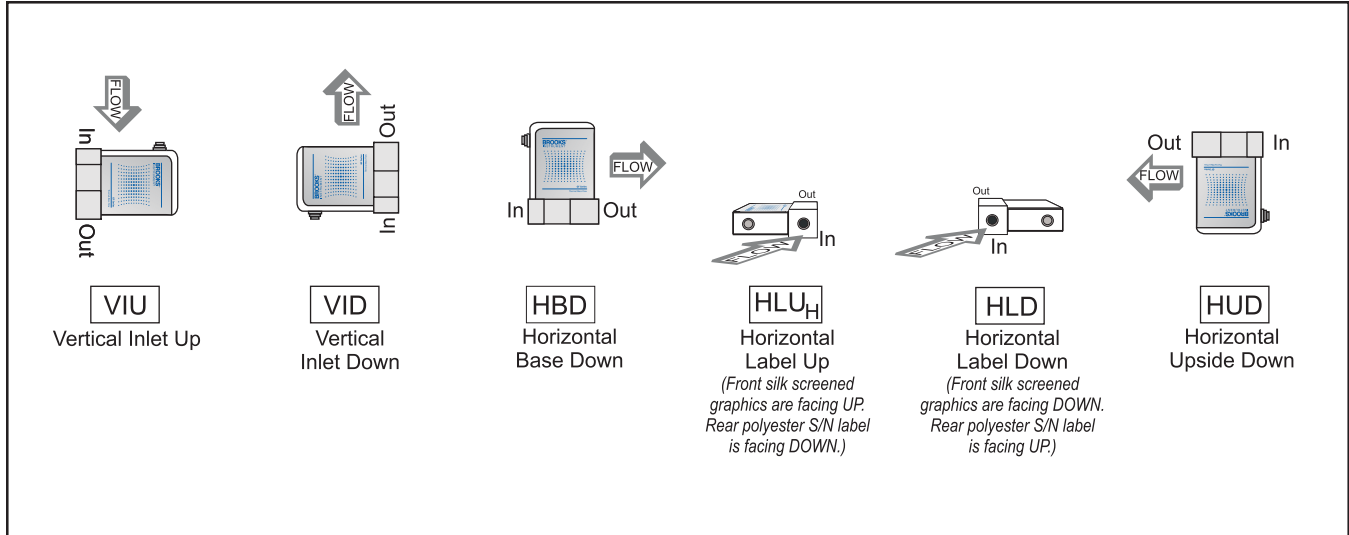

Figure 2-3 GF100 Series Mounting Attitude Positions

2-12 Position and Mount the GF100 Series

Position the GF100 Series so that the gas flow is pointed in the direction of the flow arrow on the GF100 Series rear S/N label. The various mounting positions are described in Figure 2-3

The standard orientation for the GF100 Series is Horizontal Base Down (HBD). The GF125 & GF135 employ a proprietary algorithm that utilizes the internal pressure sensor to compensate for potential orientation effects when the MFC is used with certain higher density gases. Non HBD mounting orientations can be selected by using the MultiFlo software.

In the case of the GF100/120 Series, which does not have an internal pressure sensor, it is recommended that the MFC is re-zeroed with process gas following the recommended Brooks procedure (see zeroing bulletin FSB-001-0015 for further information).

If your GF100 Series is configured with downported fittings, follow Steps 1 through 4 below. If your GF100 Series has VCR fittings, proceed to Step 5.

1. Refer to Figure 2-4. If downported fittings (1) are used, the GF100 Series is mounted to K1 Series substrate blocks (2) with four screws (3). Metal C-seals or W-seals (4) (as provided by integrator) are inserted between the GF100 Series and substrate blocks before the screws are installed. These metal seals must be replaced after each installation.
2. Select the mounting screws noted in Table 2-1 below for downported devices. M4 screws are used on 1.125" devices, K1S. M5 screws are used on 1.5" devices, K1R2 and K1H.
3. Refer to Figure 2-4. Insert the two mounting seals (4) over the gas flow path of the K1 block. Carefully align the GF100 Series mounting holes onto the K1 substrate blocks. Using your fingers, install the screws through the GF100 Series fitting and hand tighten.

GF100 Series

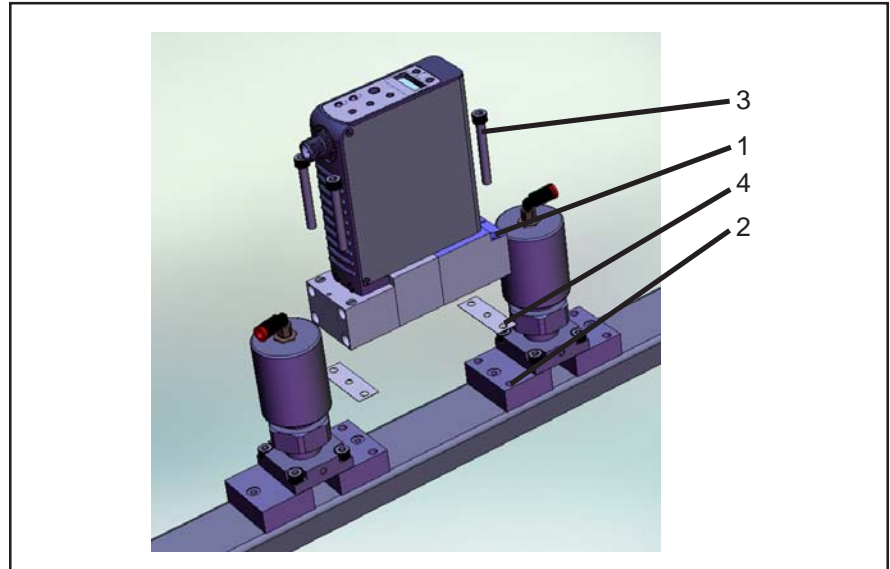

Figure 2-4 GF100 Series Mounted to K1 Series Substrate Blocks

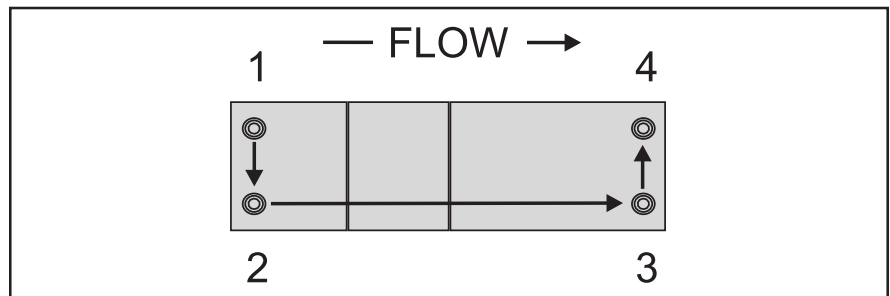

Figure 2-5 Mounting Screws Torque Pattern

Table 2-1 K1 Series Fasteners

Connection	Fastener Size		
	K1S	K1R2	K1H
GF 100 Series to Substrate	M4 x 34mm or M4 x 35mm	M5 x 30mm	M5 x 37mm

Table 2-2 K1 Substrate Torque Data

Connection	Torque Pattern	Torque (Inch-Pounds)		
		K1S	K1R2	K1H
GF125 to Substrate	Use a square pattern as shown in Figure 2-5. Start at 25 inch-pounds and increase in increments of 10 inch-pounds until proper value is obtained.	45	45	45

- Using a torque wrench and a metric hex key, tighten the screws to the torque value as described in Table 2-2 and Torque Pattern Figure 2-5.
- If your GF100 Series is configured with 1/4" VCR fittings, secure the GF100 Series block to the gas panel with two, 8-32-UNC-2B" screws. Then connect the inlet/ outlet fittings to the gas supply line using two wrenches. Tighten the fittings to manufacturer recommendations.

2-13 Perform a Leak Test

⚠ WARNING

Before operating the flow controller, ensure all gas connections have been properly tightened and, where applicable, all electrical connections have been properly terminated.

It is critical to leak test the gas supply lines and GF100 Series connections before turning on the process gas supply after any new installation. Check for leaks using a helium leak detector or any other appropriate leak test method. Follow leak test specifications as defined by integrator.

2-14 Zeroing Setup Process

The following steps are required before the GF100 Series is zeroed.

1. Make sure that the GF100 Series has been installed inside the equipment (panel) for at least four hours and powered up at least one hour prior to zeroing. This insures that the GF100 Series is in its "use attitude" and is operating at normal temperature. If the GF100 Series is subjected to a vacuum purge for more than one minute, turn off the GF100 Series (ie., provide a zero setpoint) for a time period of twice the vacuum purge time.
2. Refer to Figure 2-1. Open the upstream shut-off valve (5) and close the downstream shut-off valve (7). This eliminates a pressure drop across the GF100 Series and subsequent leakage from the PID control valve inside the GF100 Series.
3. Provide a 100% setpoint to the GF100 Series for no longer than 60 seconds. This equalizes the pressure across the PID control valve.
4. Refer to Figure 2-1. Close the upstream shut-off valve (5) to prevent any pressure effects from the regulator (3).
5. Close the GF100 Series and wait two minutes.
6. Read the output signal of the GF100 Series. This output signal is the initial flow in percent of full scale. The output signal should be 0.0 (\pm 0.1%). If the output signal is too high, re-zero the GF100 Series as described in Section 2-15.

2-15 Zeroing the GF100 Series

Many high density gases exhibit slight changes in zero output as a function of inlet pressure. Gases such as tungsten hexafluoride and many fluorocarbons are especially sensitive to this problem. Since inlet pressure is a potential source for zero errors, the pressure transducer on each GF100 Series should be correctly set to zero after installation. The zeroing process is performed from the backlight LCD display on top of the GF100 Series.

OEM tools using a microprocessor or computer for operating the GF100 Series should sequence the GF100 Series off between processes. To accomplish this, simply provide a zero set point. The GF100 Series will shut off automatically.

⚠ NOTICE

Make sure you perform the zeroing set-up process outlined in Section 2-14 before zeroing the GF100 Series.

Shut-off valves, whether upstream or downstream from the GF100 Series, should be programmed to turn on before the GF100 Series is turned on and turned off after the GF100 Series is turned off.

2-15-1 Zeroing the GF100 Series Pressure Transducer from the LCD Display Panel

1. Place the GF100 Series under a strong vacuum with the GF100 Series set to 100% set point. Make sure that upstream valve is closed and the downstream valve is open. Allow time for the upstream pressure to bleed off.
2. Looking at the top of the GF100 Series, press the "Display" button, starting at the MACID, four times to "PSI" or five times to "kPa" or until the LCD displays the labels "PSI" or "kPa". The GF100 Series will display pressure in units of PSIA or kPa. Press and hold down the Zero button a minimum of 5 seconds or until the display reads 0.000, with the last two digits flickering at different values. The pressure transducer zeroing procedure can be done while the display is either in PSIA or kPa output. Refer to Figure 2-6.

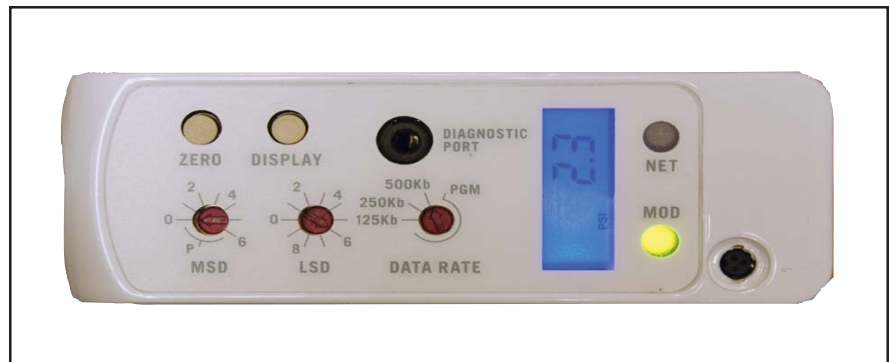

Figure 2-6 Display with PSI Reading

After completion of the pressure transducer zeroing, the LCD display will read 0.0 with the last two digits flickering as shown in Figure 2-7.

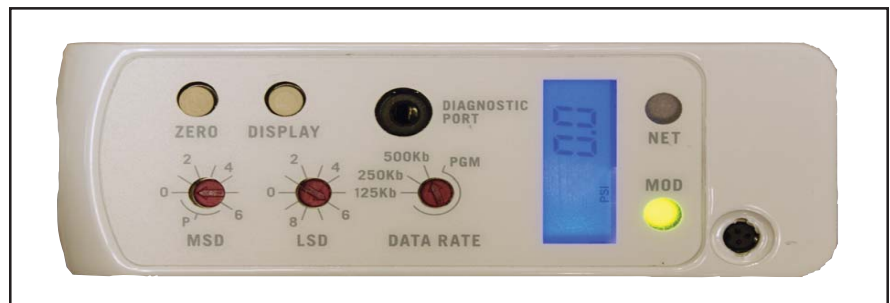

Figure 2-7 Display Reading Zero PSI

2-15-2 Zeroing GF100 Series Flow from LCD Display Panel

1. Place the GF100 Series under normal inlet operating pressure. Close the down stream valve to prevent any flow.
2. Looking at the top of the GF100 Series, press the "Display" button until the LCD display label is "%FS" as shown in Figure 2-8. Three button depressions from the MACID label display.

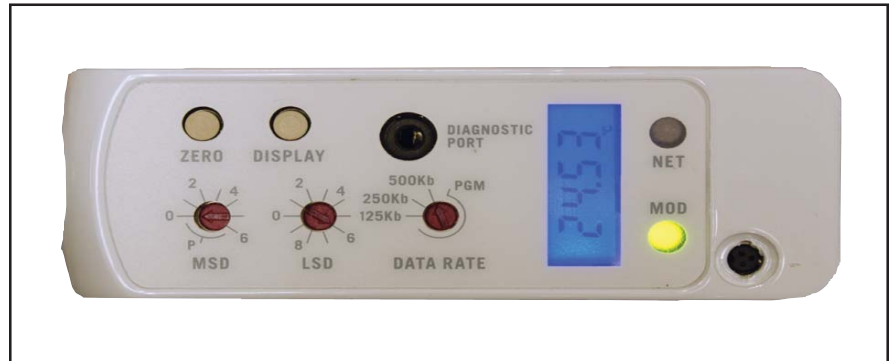

Figure 2-8 Display Set to %FS

3. Press and hold down the Zero button for a minimum of 5 seconds or until the "%FS" display reads 0.0 as shown in Figure 2-9. The %FS label will flash during this procedure.

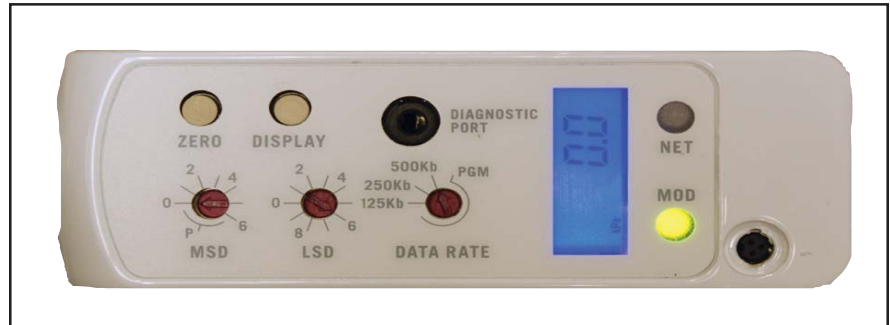

Figure 2-9 % Flow Display Set to Zero

2-16 Performance Checks

This section describes how to zero and sequence the GF100 Series devices for proper operation.

NOTICE

If the GF100 Series has been in the purge mode for a long period of time, wait until the GF100 Series has cooled down before zeroing. The cool down period should be ~30 minutes for purges up to five minutes and at least 60 minutes after purging overnight.

- The GF100 Series must be warmed up for at least 30 minutes.
- The active gas page must be correct.
- The GF100 Series pressure transducer must be correctly zeroed.
- The GF100 Series flow must be correctly zeroed.

GF100 Series

2-17 Introduction to the MultiFlo™ Configurator

The MultiFlo Configurator application is used to configure the gas and range of the GF Series devices. The following section describes the MultiFlo Configurator and its uses.

2-18 Using the MultiFlo Configurator

The MultiFlo Configurator application allows communication to GF Series devices through personal computer with serial COM Port and a Windows 10, Windows 7 or Windows XP operating system. It's primary function is to configure gas and flow ranges within six defined standard configurations. Flow ranges are configured to the Nitrogen equivalent.

Using the MultiFlo Configurator software, configure the gas and flow rate according to Table 2-3.

Table 2-3 Gas and Flow Ranges - MultiFlo Configurable - N2 Equivalent

Standard MG-MR Bin Configurations	Flow range Code	Gas Flow Range (N2 Equivalent)
SH40	010C	3-10 sccm
SH41	030C	11-30 sccm
SH42	092C	31-92 sccm
SH43	280C	93-280 sccm
SH44	860C	281-860 sccm
SH45	2.6L	861-2600 sccm
SH46	7.2L	2601-7200 sccm
SH47	015L	7201-15000 sccm
SH48	030L	15001-30000 sccm
SH49	040L	30001-40000 sccm
SH50	055L	40001-55000 sccm

The MultiFlo Configurator interfaces to the GF Series device through RS485 or DeviceNet communications. There are various ways to connect the device regardless of device configuration. Devices may be connected through the diagnostic port using cables in one of the two Basic MultiFlo Configurator Kits or DeviceNet devices can alternatively be connected using a National Instruments or SST DeviceNet scanner card.

778Z010ZZZ Basic MultiFlo Configurator Kit

A331710003 Cable Assembly 2.5mm

214F027AAA USB-RS485 Converter with DB-9 female

778Z011ZZZ Basic MultiFlo Configurator Kit

w/Power Supply and Adapter Cables

A331710003 Cable Assembly 2.5mm

214F027AAA USB-RS485 Converter with DB-9 female

A332295001 Power Supply MFC

A332297002 Cable, Power, 9-Pin

A332297001 Cable, Power, DeviceNet

Connect the MultiFlo Cable Adapter 2.5mm jack to the Diagnostic Port on the top of the device. See Figure 2-12.

Connect the RS485 end of the converter to the 9-Pin RS485 end of the MultiFlo Cable Adapter.

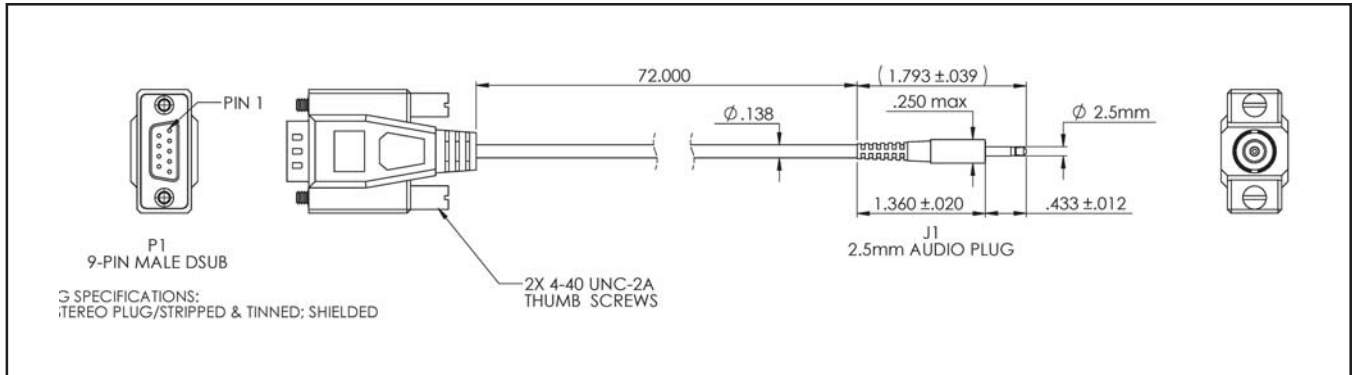

Figure 2-10 MultiFlo Cable Adapter



Figure 2-11 USB-RS485 Converter (214F027AAA)

Connect the USB end of the converter to a laptop or PC. For GF1xx devices with EtherCAT communication, the diagnostic port must be used to interface with the MultiFlo Configurator.

- Ensure the M8 power connector is attached and the device is powered on
- Only after the device is powered on, attach a micro-USB cable to the diagnostic port of the device and the USB end to a laptop or PC
- Once use of the diagnostic port is complete, remove the micro-USB cable before removing power from the device. See Figure 2-12 below



Figure 2-12 Diagnostic Port Locations

GF100 Series

The latest MultiFlo Configurator Software and Databases and MultiFlo Configurator Quick Start Guide are available on the Brooks Instrument website at: www.BrooksInstrument.com/MultiFlo. Please reference the MultiFlo Configurator Quick Start Guide for installation and operation details. Download the MultiFlo Configurator software into your computer from the Brooks Instrument website www.BrooksInstrument.com/MultiFlo. Install the MultiFlo Configurator as described in the MultiFlo Configurator Quick Start Guide and use the guide as a reference for operation details.

⚠ CAUTION

DO NOT make any connections to unlabeled connector pins. Any failure to comply could damage the GF100 Series and/or the mating electrical device. Before connecting the cable, make sure that all pin connections of the mating cable have the same pin out connections. When installing and removing cables to and from your computer, make sure the power is turned off on your computer. This will prevent damage to your computer and associated equipment.

2-19 Electrical Connections

2-19-1 DeviceNet Connections

DeviceNet is a 5 wire local network connection that employs a command response communication protocol for communicating between a master and slave. Obtain a DeviceNet communication cable (Micro M-12) and fasten it to the 5-pin connector as shown in Figure 2-13.

DeviceNet (M-12)
Connector Cable



DeviceNet 5-Pin (M-12)
Connector (M)

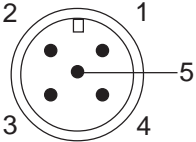

Pin	Connection
1	Drain
2	V+ (11-25 Vdc)
3	V--
4	CAN-H
5	CAN-L

⚠ CAUTION

DO NOT apply more than 10 Inch-Pounds of torque to the cable coupling when connecting the cable to the device or damage may result to the connector.

Figure 2-13 GF100 Series DeviceNet Connection

2-19-2 Analog/RS485 Connections

The GF100 Series devices are available with Analog 9-Pin D-Connectors shown in Figure 2-14.

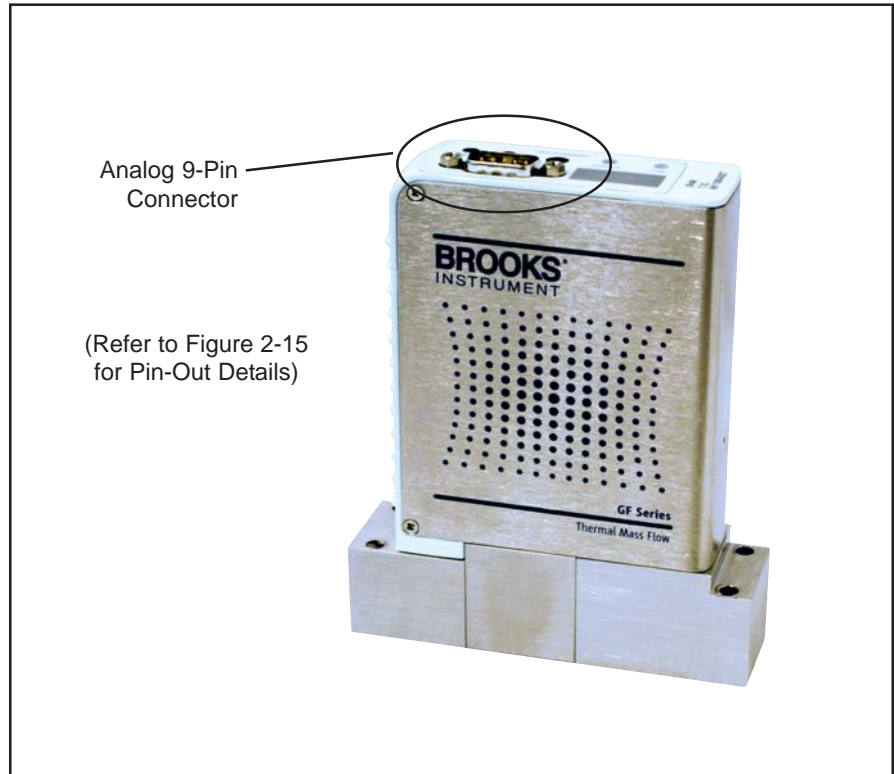

Figure 2-14 GF100 Series with 9-Pin Analog Connector

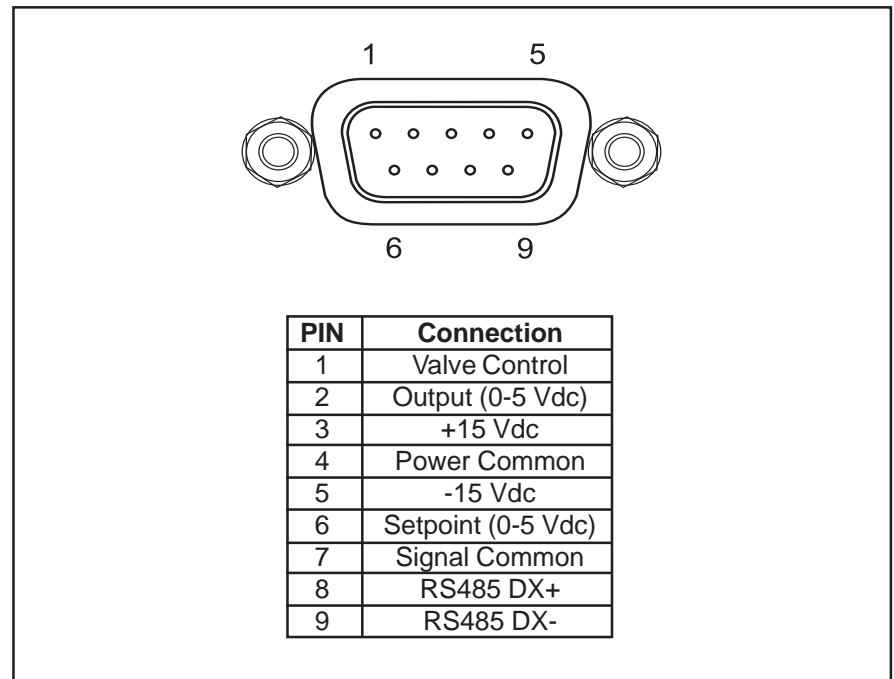

Figure 2-15 Analog 9-Pin Connector (M)

GF100 Series

2-19-3 EtherCAT Connections

Power needs to be supplied via the standard male M8 5-pin connector. The M8 connector is located on the upper inlet side of the device. Refer to Figures 2-16 and 2-17 below.



Figure 2-16 GF100 with EtherCAT Communications, M8 Power Connector Location.

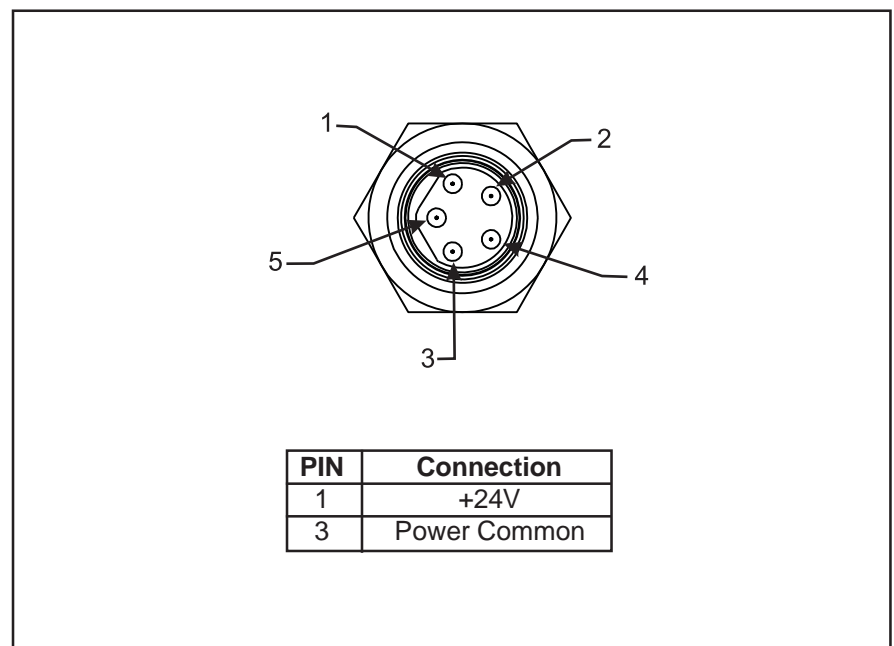
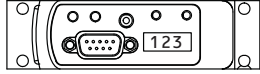

Figure 2-17 M8 Power Connector Drawing

Base I/O Options

PDC Ordering Code G1

Description: Industry standard Analog / RS485 interface



Pin No.	Signals
1	Valve Control
2	Output (0-5 Vdc)
3	+15 Vdc +24 Vdc
4	Pwr Com NC
5	-15 Vdc Pwr Com
6	Setpoint (0-5 Vdc)
7	Signal Common
8	RS-485 (DX+)
9	RS-485 (DX-)

PDC Ordering Code GX

Description: OEM specific Analog / RS485 interface. Display and top plate re-oriented 180°

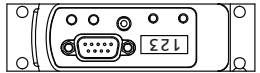

Pin No.	Signals
1	Valve Control
2	Output (0-5 Vdc)
3	+15 Vdc +24 Vdc
4	Pwr Com NC
5	-15 Vdc Pwr Com
6	Setpoint (0-5 Vdc)
7	Signal Common
8	RS-485 (DX+)
9	RS-485 (DX-)

PDC Ordering Code DX

Description: Industry standard ODVA compliant DeviceNet interface

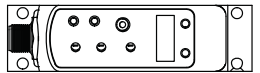

M12 Pin No.	Signals
1	Drain
2	V+ (11-25 Vdc)
3	V-
4	CAN-H
5	CAN-L

PDC Ordering Code TX

Description: Industry standard Analog only interface

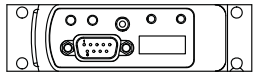

Pin No.	Signals
1	Valve Control
2	Output (0-5 Vdc)
3	+15 Vdc +24 Vdc
4	Pwr Com NC
5	-15 Vdc Pwr Com
6	Setpoint (0-5 Vdc)
7	Signal Common
8	No Connection
9	No Connection

PDC Ordering Code SX

Description: Industry standard Analog 9-Pin Sub D connector and dual RJ11 RS485 ports

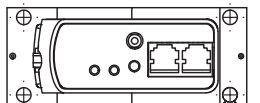

D-Sub Pin No.	Signals
1	Valve Control
2	Output (0-5 Vdc)
3	+15 Vdc +24 Vdc
4	Pwr Com NC
5	-15 Vdc Pwr Com
6	Setpoint (0-5 Vdc)
7	Signal Common
8	Signal Common
9	Valve Test Point

RJ11 J2 Pin No.	Signals
3	RS-485 (DX-)
4	RS-485 (DX+)

PDC Ordering Code BB

Description: Industry standard ODVA compliant DeviceNet interface, Plus a separate Analog 0-5 Vdc Connector

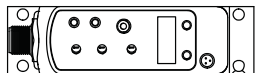

M12 Pin No.	Signals
1	Drain
2	V+ (11-25 Vdc)
3	V-
4	CAN-H
5	CAN-L

HIROSE Pin No.	Signals
1	Flow Out
2	AGND
3	GPIO CAPO
4	GHD Earth

All Base I/O options include:
 Diagnostic port communication RS485 via 2.5mm jack

I/O Options Using Base Model and Adapter Cable

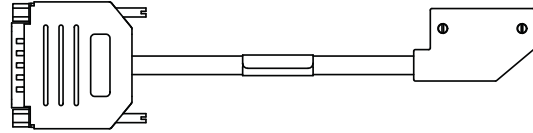

A range of low profile adapter cables have been developed to support replacing older generation MFC's with different pinout configurations. The base MFC would be either a G1, TX or SX configuration, depending on the product being replaced.

PDC Ordering Code UX

Description: SX base I/O with 7003550 adapter for compatibility with Unit UDU15

Pin No	Signals
9	VALVE OFF
6	OUTPUT (0-5 VDC)
4	+15 VDC +24 VDC
7	PWR COM NC
11	-15 VDC PWR COM
15	SETPOINT (0-5 VDC)
1,13,14	SIGNAL COMMON
2	ZERO ALARM
12	VALVE TEST POINT
8	CASE GROUND
3,5,10	NO CONNECTION

PDC Ordering Code: T1

Description: TX base I/O with 7003551 adapter for compatibility with IFlow DB15 & TN 15 pin

Pin No	Signals
15	VALVE OFF
2	OUTPUT (0-5 Vdc)
5	+15 VDC +24 VDC
1	PWR COM NC
6	-15 VDC PWR COM
8	SETPOINT (0-5 VDC)
9	COMMON
10	COMMON
14	CASE GROUND
3,4,7	NO CONNECTION
11,12,13	NO CONNECTION

PDC Ordering Code: FX / JX

Description: SX base I/O with 7003069 (FX)/7001814 (JX) adapter for compatibility with Unit UDF9/UDJ9

Pin No	Signals
1	VALVE CONTROL*
2	OUTPUT (0-5 VDC)
3	+15 VDC +24 VDC
4	PWR COM NC
5	-15 VDC PWR COM
6	SETPOINT (0-5 VDC)
7	SIGNAL COMMON
8	SIGNAL COMMON
9	VALVE TEST POINT

PDC Ordering Code: EX

Description: GX base I/O with 7003083 adapter for compatibility with Unit "E", "IN", "L", "R"

Pin No	Signals
J	VALVE OFF
3	OUTPUT (0-5 VDC)
4	+15 VDC +24 VDC
2	PWR COM NC
F	-15 VDC PWR COM
A	SETPOINT (0-5 VDC)
B,C,10	SIGNAL COMMON
1	CASE GROUND
5, 6, 8, 9	NOT CONNECTED
I, D, E, H	NOT CONNECTED
7, G	KEY WAY

RJ11 J2 Pin No	RJ11 J3 Pin No	Signals
3	3	RS-485 (DX-)
4	4	RS-485 (DX+)

PDC Ordering Code: KX

Description: G1 base I/O with 7003298 adapter for compatibility with Unit UDK15

Pin No	Signals
3	VALVE CONTROL
2	OUTPUT (0-5 VDC)
7	+15 VDC +24 VDC
5	PWR COM NC
6	-15 VDC PWR COM
8	SETPOINT (0-5 VDC)
11,12	SIGNAL COMMON
15	CASE GROUND
1, 4, 9, 10, 13, 14	NO CONNECTION

PDC Ordering Code: BX

Description: G1 base I/O with 7003590 adapter for compatibility with Brooks 15-Pin D

Pin No	Signals
12	VALVE OVERRIDE
2	OUTPUT (0-5 VDC)
5	+15 VDC +24 VDC
9	PWR COM NC
6	-15 VDC PWR COM
8	SETPOINT (0-5 VDC)
1,10	SIGNAL COMMON
3,4,7,11	NO CONNECTION
13,14,15	NO CONNECTION

Other adapter options are available for the GF Series. Please contact Brooks Customer Service for more information.

Figure 2-18 GF100 Series Electrical Interface Options

GF100 Series

2-20 GF135 Inlet Valve Installation

When installing the GF135 –

1. Connect the MFC tubing labeled "IN" to a CDA or N2 supply of 90 ± 3 psi.
2. Next, the MFC tubing labeled "OUT" should be connected to the customer upstream pneumatic isolation valve.

Note – The air passes through a failsafe normally open valve inside the GF135 and is connected back to the inlet isolation valve. For safe operation and in line with S2 compliance, the GF135 cannot override and open the inlet isolation valve.

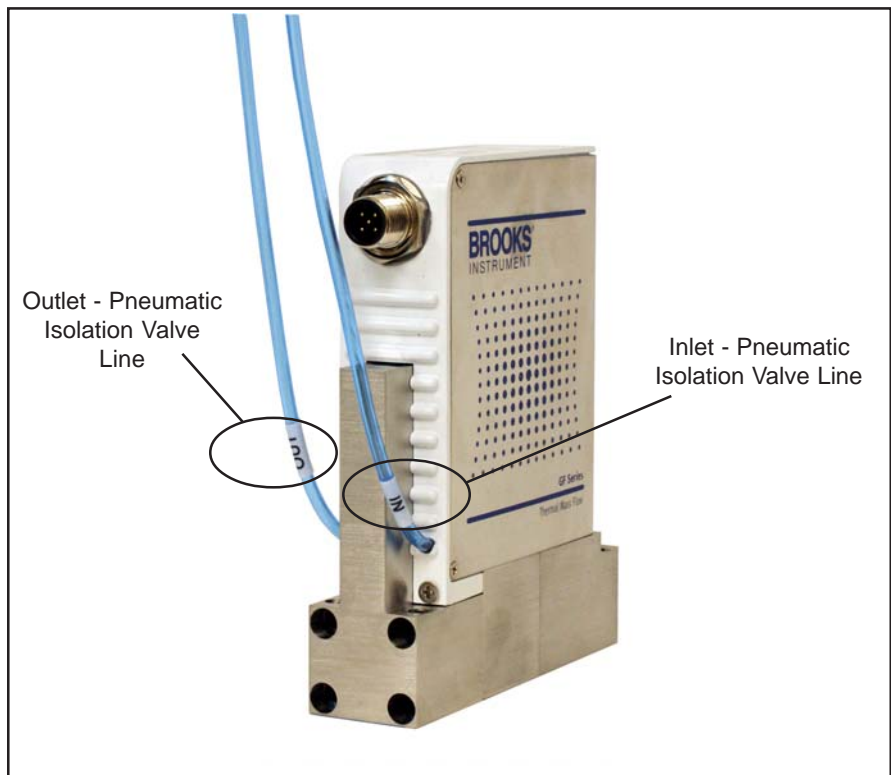

Figure 2-19 GF135 Series Showing Inlet/Outlet Pneumatic Isolation Valve Lines

2-21 GF135 Commissioning

Download the GF135 commissioning software, part number 805-C-026, from the Brooks Instrument website. The software will need to be downloaded onto a computer with a Windows® based operating system.

Necessary equipment:

- Computer that runs a Windows operating system
- Power (either DeviceNet or RS485) to the device or M8 EtherCAT power
- Need gas supply for pneumatic valve (90 ±3 psi)
- BB 485 to 232 converter or approved USB to 485 converter
- 9-pin to diagnostic cable

In order to ensure best results, commission the GF135 at operating temperature and pressure on tool.

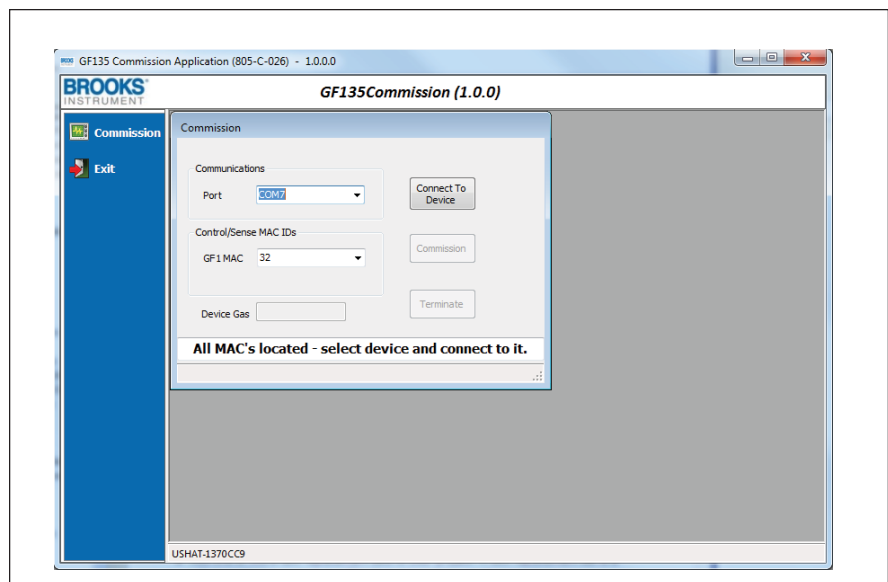

1. Start up the GF135 Commission Application and select a port. This will bring up all of the devices on this port.

GF100 Series

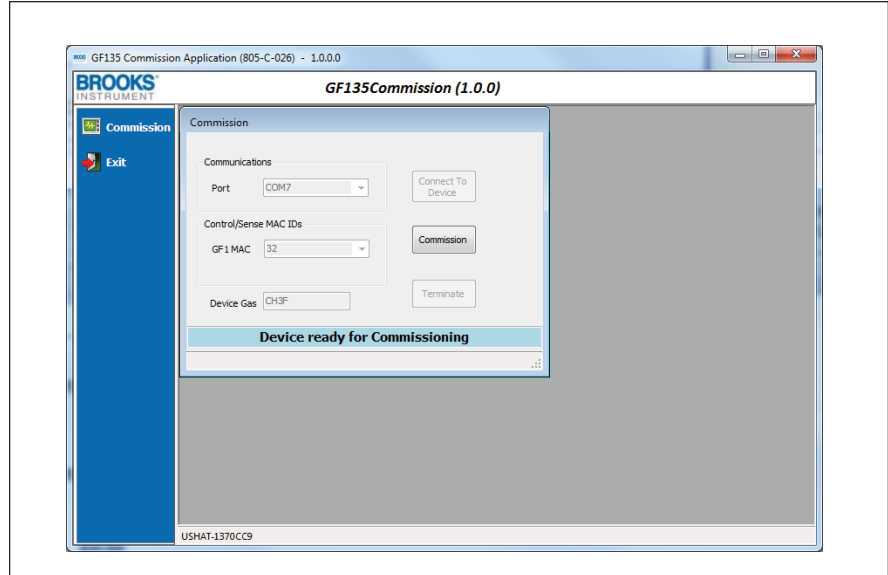

2. Select the single device that you want to perform the commissioning and click on "Connect to Device". The Commissioning button becomes enabled.

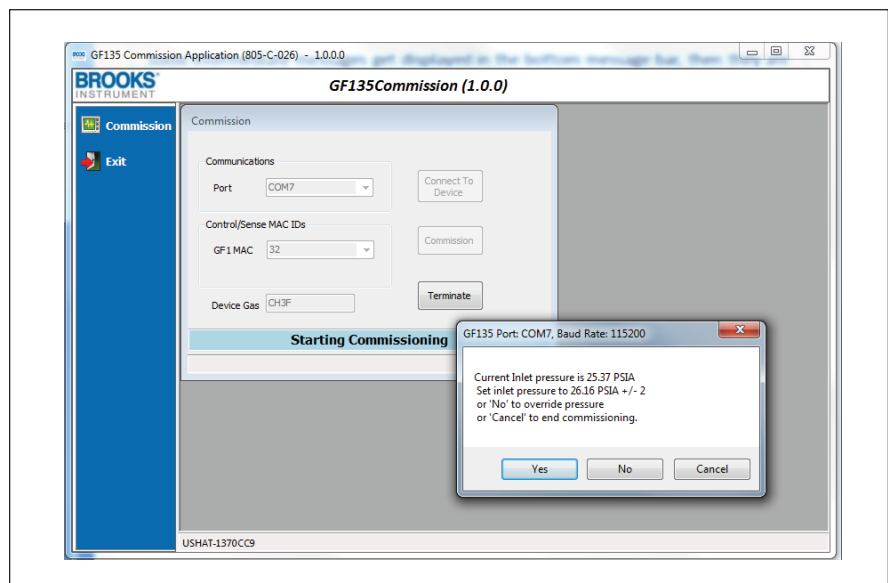

3. Click on the "Commission" button to begin the process. Some intermediate messages will appear on the bottom message bar. You will then be presented the option to override the current inlet gas pressure. Selecting "Yes" will keep the current inlet pressure. Selecting "No" will allow the user to override the pressure. Selecting "Cancel" will end the commissioning process.

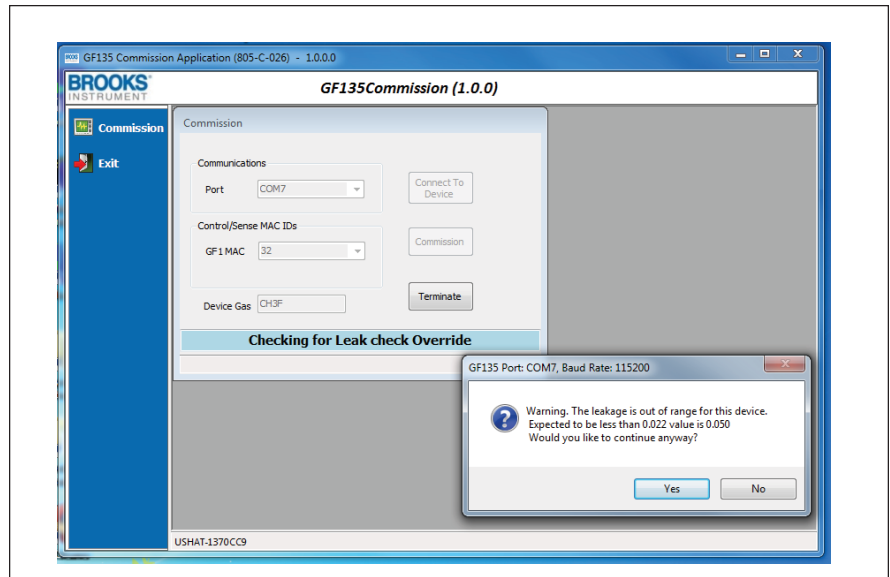

4. The user will be presented the option to override a few of the parameters being tested prior to actual commissioning. Selecting "Yes" will continue the process. By selecting "No" the commissioning process will end.

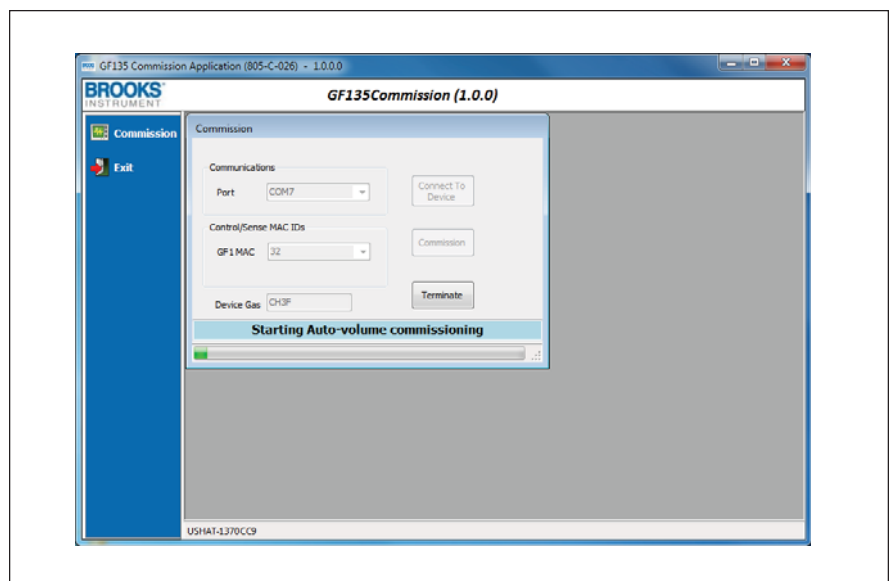

5. After numerous checks are performed, the auto-volume will start. This will take approximately 5 minutes to complete. The K1 setpoints will then begin. This process will run for approximately 40-90 minutes.

GF100 Series

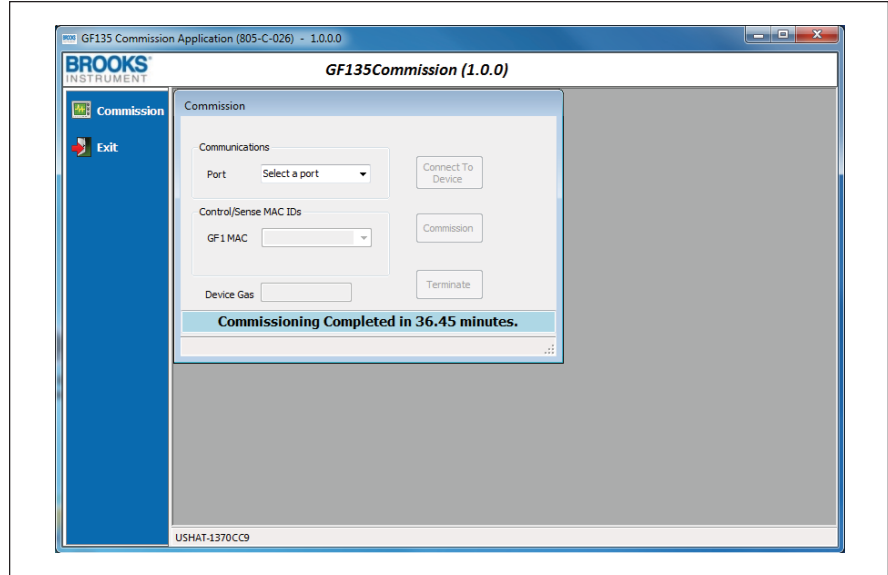

6. Once the auto-volume and the K1 set points are complete, the program will go back to the initial screen. In addition, the overall run time will be displayed. From here, another device (or the same one again) may be selected for commissioning.

3-1 General

After the device has been properly installed in the process, it is ready for operation. When initiating flow, slowly open any upstream shutoff valve to avoid a flow surge. A bypass is helpful in bringing the flow on smoothly. Avoid starting a pump to supply the device without the use of a valve upstream of the device.

⚠ CAUTION

Any sudden change in system pressure may cause mechanical damage to elastomer materials. Damage can occur when there is a rapid expansion of fluid that has permeated elastomer materials. The user must take the necessary precautions to avoid such conditions.

⚠ WARNING

Before operating the flow controller, ensure all gas connections have been properly tightened and, where applicable, all electrical connections have been properly terminated.

3-2 Theory of Operation for Flow Measurement

The thermal mass flow measurement system consists of two components: the restrictor or bypass and the flow sensor. Figure 3-1 is diagram of the flow stream through the device, with an enlarged view of the flow sensor. Gas flow entering the device is separated into two paths; one straight through the restrictor and the other through the flow sensor. This is represented in Figure 3-1, where the total flow $A+B$ enters the device and is separated into streams A and B . The streams are joined again at the far side of the restrictor.

The separation of the flow streams is caused by the restrictor. During flow conditions, there will be a pressure differential across the restrictor that forces gas to flow in the sensor.

The pressure difference caused by the restrictor varies linearly with total flow rate. The sensor has the same linear pressure difference versus flow relationship. The ratio of sensor flow to the flow through the restrictor remains constant over the range of the device ($A/B = \text{constant}$). The full scale flow rate of the device is established by selecting a restrictor with the correct pressure differential for the desired flow.

The flow sensor is a very narrow, thin-walled Hastelloy tube. Onto this tube are built upstream and downstream temperature sensing and heating elements. During no-flow conditions, the amount of heat reaching each temperature sensor is equal, so temperatures T_1 and T_2 (Figure 3-1) are equal. Gas flowing through the tube carries heat away from the upstream temperature sensor and toward the downstream sensor. The temperature difference, $T_2 - T_1$, is directly proportional to the gas mass flow.

GF100 Series operating principles are described in Figure 3-1.

GF100 Series

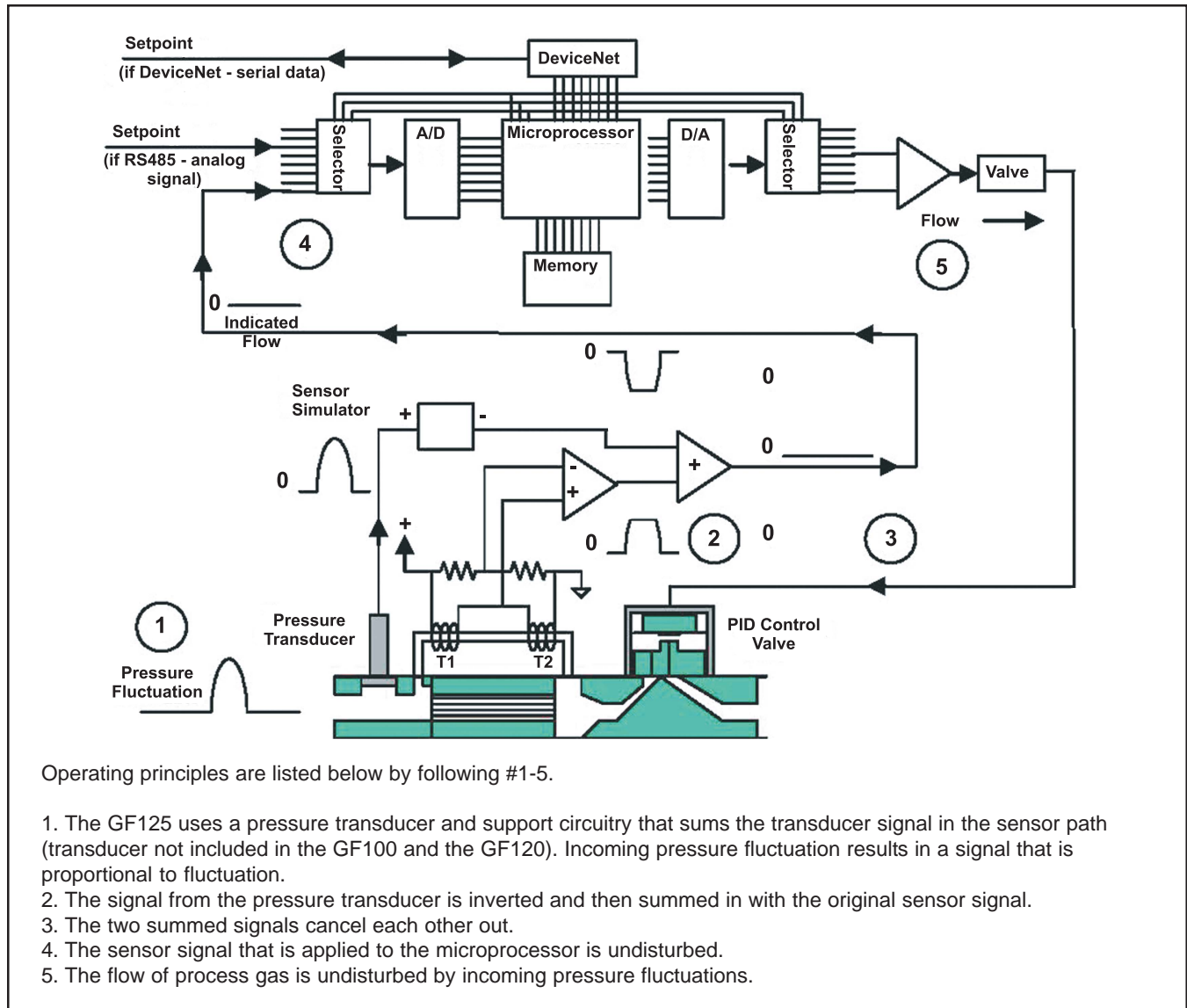
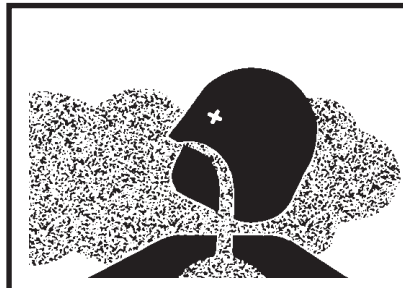

Figure 3-1 GF100 Series Operating Principles

4-1 Overview

No routine maintenance is required on the Brooks GF100 Series devices. If an in-line filter is used, the filtering elements should be periodically replaced or cleaned. Any precision unit such as a flow controller requires occasional servicing, especially if it has been operating for an extended period of time. If reactive gases are being used, it is recommended that you send the device to a Brooks Service Center for cleaning and recalibration. Please follow the instructions for removal, product packaging and product return instructions found in Section 2- Installation—Return Shipment. All active process instrumentation and equipment is subject to aging and wear from their environment. This includes temperature, mechanical stress, component tolerance shift, contaminant buildup, oxidation, and other influences. The effects are gradual, but over time the changes can affect the accuracy of even the best equipment. Therefore, it is recommended to re-zero the device at 6 month intervals. Refer to Section 2-18 Performance Checks for re-zeroing instructions.

4-2 Maintenance



⚠ WARNING

METER/CONTROLLER SEAL COMPATIBILITY

Products in this manual may contain metal or elastomeric seals, gaskets, O-rings or valve seats. It is the "user's" responsibility to select materials that are compatible with their process and process conditions. Using materials that are not compatible with the process or process conditions could result in the Meter or Controller leaking process fluid outside the pressure boundary of the device, resulting in personnel injury or death.

It is recommended that the user check the Meter or Controller on a regular schedule to ensure that it is leak free as both metal and elastomeric seals, gaskets, O-rings and valve seats may change with age, exposure to process fluid, temperature, and /or pressure.

⚠ WARNING

If it becomes necessary to remove the controller from the system after exposure to toxic, pyrophoric, flammable or corrosive gas, purge the controller thoroughly with a dry inert gas such as Nitrogen before disconnection the gas connections. Failure to correctly purge the controller could result in fire, explosion or death. Corrosion or contamination of the mass flow controller, upon exposure to air, may also occur.

⚠ WARNING

If it becomes necessary to remove the instrument from the system, power to the device must be disconnected.

⚠ CAUTION

It is important that this MFC/MFM only be serviced by properly trained and qualified personnel.

⚠ CAUTION

This instrument contains electronic components that are susceptible to damage by static electricity. Proper handling procedures must be observed during the removal, installation or other handling of internal circuit boards or devices.

4-3 Troubleshooting

This section includes a Troubleshooting Checklist and a GF100 Series Troubleshooting Guide that identifies symptoms, possible causes, and corrective actions.

⚠ NOTICE

OEM tool problems are often caused by something other than the GF100 Series. Therefore, Brooks recommends that you review both the Troubleshooting Checklist and the GF100 Series Troubleshooting Guide before removing the GF100 Series from your system. It is also suggested to contact your Brooks Service representative before removing the GF100 Series from your system.

4-4 Troubleshooting Checklist

1. Check environmental factors that could affect changes to GF100 Series performance. The most common environmental factors are listed in Table 4-1.

Table 4-1 Environmental Factors

GF100 Series Performance	Possible Causes
Inaccurate flow.	Temperature shift (steady state or transient). Inlet pressure shift (steady state or transient). Power supply problem. Electrical interference Dirty gas chamber Changes in gas.
Control problems. Can not reach setpoint. Oscillation.	Differential pressure not within operating range Inlet pressure not stable
Zeroing problems, Indicated zero is not stable.	Temperature shift (steady state or transient). Inlet pressure shift (steady state or transient). Power supply problem. Electrical interference

2. Check supply voltage and check for a consistent ground.
3. Insure OEM tool setpoint matches the setpoint at the GF100 Series. Observe for consistency.
4. Verify isolations valves are open and the gas supply is turned on. Then verify operating pressures are within operating ranges.
5. Check GF100 Series voltage response by moving the setpoint back and forth. Observe for voltage changes.

GF100 Series

4-5 GF100 Series Troubleshooting Guide

Table 4-2 GF100 Series Troubleshooting Guide

Symptoms & Possible Causes	Corrective Action
1. No gas flow.	
Is the gas supply turned on?	Check shut-off valve and pressure readout. Open the gas supply.
Is the regulator turned on at the correct operating pressure?	Turn off the regulator and reset it to the recommended pressure as described in the Data Sheet.
Are any upstream or downstream shut-off valves closed, either by the system or because of failure?	Verify that the valves are open and operating properly.
Is the MOD LED light on the GF100 Series lit solid green?	Observe the LED display panel on top of to verify. If the LED light is not lit, cycle power the to reboot.
Is the commanded setpoint from tool/system at 0.00 Vdc?	Use the tool software to verify.
Has the been commanded off by an active "valve closed" input?	Use the tool software to verify.
2. Flow out of range.	
Is the gas inlet/outlet pressure differential either too high or too low? NOTE: If the differential pressure is too high, voltage to the will be zero, which is abnormally low for the setpoint. If the differential is too low, voltage to will be at its maximum value, which is abnormally high for the set-point.	Verify that the pressure is correct for the gas and range. If required, adjust inlet/outlet pressure to achieve proper pressure reading.
Is the MOD LED light on the GF100 Series lit solid green?	Observe the LED display panel at top of . If the LED light is not lit, cycle power the to reboot.
Is the setpoint correct for the required gas flow?	Use the tool software to verify.
Is the calibrated for the particular gas?	Check the side label. Run a flow check to verify.
Is the zero correct?	Zero the according to zeroing procedure in Section 2-14. Verify leak check rates are OK.
3. No gas control; flow is at or above maximum.	
Is the gas pressure across the too high?	Verify that the pressure is correct for the gas and range. If required, adjust inlet/outlet pressure to achieve proper pressure reading.
Are system valves open, or is the purge input activated?	Use tool software to verify.
Is the setpoint correct for the required flow?	Use tool software to verify.

Table 4-2 GF100 Series Troubleshooting Guide (Continued)

Symptoms & Possible Causes	Corrective Action
4. No gas flow above some set-point.	
<p>NOTE: When the setpoint is increased beyond this point, the GF100 Series signal remains at some value lower than the set-point.</p> <p>Is the gas inlet/outlet differential pressure sufficient?</p> <p>NOTE: If the pressure reading is too low, the valve voltage to the GF100 Series will be at its maximum output. This condition will cause internal GF valve heating and inability to properly reach desired flow setpoints.</p>	<p>Verify that the pressure is correct for the gas and range. If required, adjust regulator to achieve proper pressure</p>
Is the GF100 Series calibrated for the gas flow?	Check GF100 Series side label. Run a flow check to verify. If flow is incorrect, replace the GF100 Series with a unit that is calibrated properly.
5. No gas flow below some set-point.	
<p>NOTE: When the setpoint is decreased below this point, the GF100 Series signal remains at some value higher than the setpoint.</p> <p>Is the gas inlet/outlet differential pressure too high, or above published setpoints?</p> <p>NOTE: If the differential pressure reading is too high, voltage to the GF100 Series will be at its maximum value when the setpoint is decreased below the point where flow decreases.</p>	<p>Verify that the pressure is correct for this gas and range. If required, adjust regulator to achieve proper pressure</p>
Is the GF100 Series leaking?	Check for contamination. Test the GF100 Series for leak integrity. Replace the Unit GF100 Series if leakage is detected.
6. Gas flow, or GF100 Series pressure reading oscillates.	
Is the GF100 Series calibrated for the gas flowing?	Check the GF100 Series side can label. Run a flow check to verify. If flow is incorrect, replace the GF100 Series.
Is there too much gas pressure across the GF100 Series?	Verify that the pressure is correct for this gas and range. If required, adjust regulator to achieve proper pressure reading.

GF100 Series

Table 4-2 GF100 Series Troubleshooting Guide (Continued)

Symptoms & Possible Causes	Corrective Action
<p>6. Gas flow, or GF100 Series pressure reading oscillates.</p>	
<p>Are inlet and outlet pressures stable?</p> <p>NOTE: Most GF100 Series calibrated with nitrogen will oscillate with hydrogen or helium.</p>	<p>If outlet pressure is unstable, check for (no oscillation or hunting) a faulty vacuum pump, or hunting at a downstream valve.</p> <p>Check inlet pressure on tool. A faulty pressure regulator can make the GF100 Series appear to oscillate.</p> <p>Adjust inlet pressure up or down by 2 psig increments until hunting disappears. Verify common gas pressure is within range.</p> <p>NOTE: Hunting or oscillation can be contributed to multiple GF100 Series sharing a common gas manifold. Therefore, inspect gas delivery sources to the gas box. (for example; two tools sharing a common gas bottle and calling for gas at the same time.) Valve leak. Unregulated gas pressure from Facilities.</p>
<p>7. GF100 Series does not read zero pressure when gas is shut off.</p>	
<p>Is the differential pressure across the GF100 Series really zero?</p> <p>Is the GF100 Series configured properly in the tool software?</p> <p>Is the GF100 Series mounted to the proper attitude?</p>	<p>Verify that the pressure is correct for the gas and range. If the GF100 Series has been contaminated, it may not be able to close, and therefore, will not zero. Equalize the pressure across the GF100 Series by opening it briefly. Set up the GF100 Series for zeroing. Then perform the zeroing procedure in Section 2-14. Use the tool software to verify.</p> <p>Refer to the side can label on the GF100 Series. The GF100 Series should be calibrated in the attitude it will be operating at.</p>
<p>8. OEM tool does not read correct GF100 Series zero reading.</p>	
<p>Is the differential pressure across the GF100 Series really zero?</p> <p>Is the supply voltage within specified range?</p> <p>Is the GF100 Series mounted in the proper attitude?</p> <p>Is the flow output signal of the GF100 Series really zero?</p>	<p>GF100 Series valve leakage. Incorrect MFC zero.</p>
<p>9. Zero Drift.</p>	
<p>Improper zero of the GF100 Series?</p> <p>Excessive Valve leakage?</p>	<p>GF100 Series aging or sensor stabilization. Zero is not correct.</p>

Table 4-2 GF100 Series Troubleshooting Guide (Continued)

Symptoms & Possible Causes	Corrective Action
10. Calibration Drift.	
Gas box temperature too high? Is it linear offset?	Zero is not correct.
11. GF100 Series indicates Overshoot.	
	If the tool is idle for an extended period of time, high inlet pressure or contamination will cause overshoot on first use.
12.OEM tool indicates the wrong full scale value for GF100 Series.	
	Older version of Multiflo Configurator used to program GF100 Series.
13. GF100 Series dumps large volume of gas into chamber when setpoint is commanded from the tool.	
	The tool is commanding a setpoint before the pneumatic valves are opened. GF100 Series and pneumatic timing may be offset. GF100 Series overshoots.
14. Tool display output doesn't match GF100 Series flow output.	
Cable resistance causing offset in the tool's display.	Check GF100 Series zero.

*THIS PAGE WAS
INTENTIONALLY
LEFT BLANK*

5-1 Overview

Reference Tables 5-1 through 5-5 for specific Product Description Codes.

Table 5-1 GF100, GF120 & GF125 Series Product Description Code

Code Description	Code Option	Option Description
I. Base Model Code	GF	High Purity/Ultra High Purity Digital Mass Flow Controllers
II. Package / Finish Specifications	100	Flow range 3 sccm -55 slpm N ₂ Eq.; ± 1.0% SP Accuracy; 1 sec Response; 10 Ra
	120	Flow range 3 sccm -55 slpm N ₂ Eq.; + 1.0% SP Accuracy; 700 msec Response; 4 Ra
	125	Pressure Transient Insensitive (PTI) Flow range 3 sccm -55 slpm N ₂ Eq.; + 1.0% SP Accuracy; 300-700 msec Response; 4 Ra
III. Configurability	C	MultiFlo capable. Standard bins or specific gas/range may be selected.
	X	Not MultiFlo capable. Specific gas/range required. (must select w/ SD, SL or HA special application)
IV. Special Application	XX	Standard
	SL	Safe Delivery System (GF120 Only) Full scale flow range; 4 to 25 sccm, Nitrogen Equivalent
	SD	Safe Delivery System (GF120 Only) Full scale flow range; >25 sccm to 1 slpm, Nitrogen Equivalent
V. Valve Configuration	O	Normally Open valve (not available with SD, SL or HA options)
	C	Normally Closed valve (must select with SD, SL or HA special application)
	M	Meter (No Valve)
VI. Gas or SH MultiFlo Bin	XXXX XXXX	Specific Gas Code & Range, i.e. "0004" = Argon and "010L" = 10 slpm (must select w/ SD, SL or HA special application).
	SH40 010C	Standard Configuration #40, 3-10 sccm Nitrogen Equivalent (0° C Reference)
	SH41 030C	Standard Configuration #41, 11-30 sccm Nitrogen Equivalent (0° C Reference)
	SH42 092C	Standard Configuration #42, 31-92 sccm Nitrogen Equivalent (0° C Reference)
	SH43 280C	Standard Configuration #43, 93-280 sccm Nitrogen Equivalent (0° C Reference)
	SH44 860C	Standard Configuration #44, 281-860 sccm Nitrogen Equivalent (0° C Reference)
	SH45 2.6L	Standard Configuration #45, 861-2600 sccm Nitrogen Equivalent (0° C Reference)
	SH46 7.2L	Standard Configuration #46, 2601-7200 sccm Nitrogen Equivalent (0° C Reference)
	SH47 015L	Standard Configuration #47, 7201-15000 sccm Nitrogen Equivalent (0° C Reference)
	SH48 030L	Standard Configuration #48, 15001-30000 sccm Nitrogen Equivalent (0° C Reference)
	SH49 040L	Standard Configuration #49, 30001-40000 sccm Nitrogen Equivalent (0° C Reference)
SH50 055L	Standard Configuration #50, 40001-55000 sccm Nitrogen Equivalent (0° C Reference)	
VII. Fitting	VX	1-1/2" body width, 124mm 1/4" VCR male
	VS	1-1/8" body width, 124mm 1/4" VCR male
	CX	1-1/8" body width, 92mm C Seal
	DX	1-1/8" body width, 79.8mm C Seal
	EX	1-1/2" body width, 79.8mm W Seal
	WX	1-1/8" body width, 92mm W Seal
	YX	1-1/8" body width, 79.8mm W Seal
	AX	1-1/2" body width, 92mm C Seal
	BX	1-1/2" body width, 92mm W Seal
	LX	1-1/8" body width, 92mm C Seal w/Poke Yoke
	AS	1-1/2" body width, 92mm 0.440" large bore C Seal (only for bins SH45-SH50)
VIII. Downstream Condition	A	Atmosphere
	V	Vacuum; Default for SD, SL and HA special application
IX. Sensor	O	Default Sensor Orientation

Model Code continued on next page.

GF100 Series

Table 5-1 GF100, GF120 & GF125 Series Product Description Code (Continued)

Code Description	Code Option	Option Description										
X. Connector	BX	Cable adapter to 15 pin D Brooks (Unit "B", "N") adapts G1 base										
	EX	Cable adapter to Card Edge (w/out VTP), RS485 through RJ11 jacks (Unit "E"; IN "L", "R") adapts GX base (Not Available on 79.8mm fitting DX, YX, EX)										
	FX	Cable adapter with 9 pin STEC pin-out & jack screws (w/VTP) (Unit "F", "O") adapts SX base										
	GX	9-Pin D with RS485 (Unit "G"); display and overlay 180° orientation (Not Available on 79.8mm fitting DX, YX, EX)										
	G1	9-Pin D with RS485 (Unit "G") (Not Available on 79.8mm fitting DX, YX, EX)										
	JX	Cable adapter with 9 pin STEC pin-out & jack screws (w/VTP) (Unit "J", "W") adapts SX base										
	KX	Cable adapter to MKS 15-Pin D (Unit "K") adapts G1 base										
	SX	9 pin D with STEC pin-out (w/VTP) (Unit "S", "Q")										
	TX	9 pin D with UDT9 pin-out (UDT9)										
	T1	Cable adapter to 15 pin D (IFlow DB15 & TN 15 pin) adapts TX base (Not Available on 79.8mm fitting DX, YX, EX)										
	UX	Cable adapter to 15 pin D (w/VTP) (Unit & TN "U") adapts SX base										
	BB	DeviceNet™ Analog (Not Available on 79.8mm fitting DX, YX, EX)										
		DeviceNet Standard Configuration Parameters										
		I/O	Connector	Power On State	Full Scale Setting	Full Scale Setting	Full Scale Setting	Poll IO Instance Producer	Poll IO Instance Consumer	Poll IO State Transition	External Baud Rate	
	D0	DeviceNet	5 Pin Micro	Idle	Count	Integer	6000h	2	7	Executing	500KB	
	D1	DeviceNet	5 Pin Micro	Idle	Count	Integer	6000h	21	7	Executing	500KB	
	D2	DeviceNet	5 Pin Micro	Idle	SCCM	Float	7FFFh	13	19	Executing	500KB	
	D3	DeviceNet	5 Pin Micro	Idle	Count	Integer	6000h	22	7	Executing	500KB	
	D4	DeviceNet	5 Pin Micro	Executing	Count	Integer	6000h	22	8	Executing	500KB	
	D5	DeviceNet	5 Pin Micro	Idle	Count	Integer	6000h	6	8	Executing	500KB	
D6	DeviceNet	5 Pin Micro	Idle	Count	Integer	7FFFh	3	7	Executing	500KB		
D7	DeviceNet	5 Pin Micro	Idle	Count	Integer	7FFFh	6	8	Executing	500KB		
D8	DeviceNet	5 Pin Micro	Idle	Count	Integer	6000h	3	7	Executing	500KB		
D9	DeviceNet	5 Pin Micro	Executing	Count	Integer	6000h	2	7	Executing	500KB		
DA	DeviceNet	5 Pin Micro	Idle	Count	Integer	7FFFh	22	7	Executing	500KB		
DB	DeviceNet	5 Pin Micro	Idle	Count	Integer	6000h	22	8	Executing	500KB		
DC	DeviceNet	5 Pin Micro	Idle	Count	Integer	7FFFh	3	7	Idle	500KB		
DD	DeviceNet	5 Pin Micro	Executing	Count	Integer	7FFFh	22	8	Executing	500KB		
DE	DeviceNet	5 Pin Micro	Executing	Sccm	Float	6000h	15	19	Executing	500KB		
DX	DeviceNet	5 Pin Micro	To be defined by CSR									

Code Description	Code Option	Option Description
XI. Customer Special Request	XXXX	Customer Special Request Number; required with "DX, BB" Conn. Option to define DNet settings
XII. Auto Shut-Off	A	Auto Shut-Off (Included) Default for SD and SL special application
	X	Auto Shut-Off (Not Included) (Must be selected for meter)
XIII. Auto Zero	X	Auto Zero (Not Included)
XIV. Reference Temperature	000	0°C Reference Calibration (Standard) - Default Setting

Sample Standard Model Code

I	II	III	IV	V	VI	VII	VIII	IX	X	XI	XII	XIII	XIV
GF	100	C	XX	M	- SH40010C	- VX	A	0	GX	- XXXX	A	X	- 000

Sample Safe Delivery System (SDS) Model Code

I	II	III	IV	V	VI	VII	VIII	IX	X	XI	XII	XIII	XIV
GF	120	X	SD	C	- XXXXXXXX	- EX	V	0	SX	- XXXX	A	X	- 000

Table 5-2 GF100, GF120 & GF125 Series with EtherCAT Communications Product Description Code

Code Description	Code Option	Option Description
I. Base Model Code	GF	High Purity/Ultra High Purity Digital Mass Flow Controllers
II. Package / Finish Specifications	100	Flow range 3 sccm - 55 slpm N2 Equivalent.; 1 sec Response; 10 Ra
	120	Flow range 3 sccm - 55 slpm N2 Equivalent.; 700 msec Response; 5 Ra
	125	Pressure Transient Insensitive (PTI) Flow range 3 sccm -55 slpm N2 Equivalent; 300-700 msec Response; 5 Ra
III. Configurability	C	MultiFlo capable. Standard bins or specific gas/range may be selected.
	X	Not MultiFlo capable. Specific gas/range required. (must select w/ SD or SL special application)
IV. Special Application	XX	Standard
	SL	Safe Delivery System (GF120 Only) Full scale flow range; 4 to 25 sccm, N2 Equivalent
	SD	Safe Delivery System (GF120 Only) Full scale flow range; 25 sccm to 1 slpm, N2 Equivalent
V. Valve Configuration	O	Normally Open valve (not available with SD, SL or VS options)
	C	Normally Closed valve
	M	Meter (No Valve)
VI. Gas or SH MultiFlo Bin	XXXX XXXX	Specific Gas Code & Range, i.e. "0004" = Argon and "010L" = 10 slpm
	SH40 010C	Standard Configuration #40, 3-10 sccm Nitrogen Equivalent
	SH41 030C	Standard Configuration #41, 11-30 sccm Nitrogen Equivalent
	SH42 092C	Standard Configuration #42, 31-92 sccm Nitrogen Equivalent
	SH43 280C	Standard Configuration #43,93-280 sccm Nitrogen Equivalent
	SH44 860C	Standard Configuration #44, 281-860 sccm Nitrogen Equivalent
	SH45 2.6L	Standard Configuration #45, 861-2600 sccm Nitrogen Equivalent
	SH46 7.2L	Standard Configuration #46, 2601-7200 sccm Nitrogen Equivalent
	SH47 015L	Standard Configuration #47, 7201-15000 sccm Nitrogen Equivalent
	SH48 030L	Standard Configuration #48, 15001-30000 sccm Nitrogen Equivalent
	SH49 040L	Standard Configuration #49, 30001-40000 sccm Nitrogen Equivalent
SH50 055L	Standard Configuration #50, 40001-55000 sccm Nitrogen Equivalent	
VII. Fitting	VS	1-1/8" body width, 1/4" VCR male
	VX	1-1/2" body width, 1/4" VCR male
	CX	1-1/8" body width, C Seal 92mm
	WX	1-1/8" body width, W Seal 92mm
VIII. Downstream Condition	A	Atmosphere
	V	Vacuum
IX. Sensor	O	Default Sensor Orientation
X. Connector	E0	EtherCAT Communication
XI. Customer Special Request	XXXX	Customer Special Request Number
XII. Auto Shut-Off	A	Auto Shut-Off (Included)
	X	Auto Shut-Off (Not Included)
XIII. Auto Zero	X	Auto Zero (Not Included)
XIV. Reference Temperature	000	0 deg C Reference Calibration (Standard) - Default Setting

GF100 Series

Table 5-3 Model GF135 Product Description Code

Code Description	Code Option	Option Description									
I. Base Model Code	GF										
II. Package/Finish Specifications	135	Pressure Transient Insensitive (PTI) Ultra High Purity Advanced Diagnostic MFC									
III. Configurability	X	Gas specific									
IV. Special Application	XX	Standard Application									
V. Valve Configuration	C	Normally Closed Valve									
VI. Specific Gas Code & Range	XXXX XXXX	Specify Gas Code & Range, i.e. "0004" = Argon and "010L" = 10 slpm									
VII. Fitting	VX	1 1/2" VCR 1/4"									
	CX	1 1/8" C Seal 92mm									
	WX	1 1/8" W Seal 92mm (FUTURE RELEASE)									
VIII. Downstream Condition	A	Atmosphere									
	V	Vacuum									
IX. Sensor	O	Default Orientation									
X. Connector	DeviceNet Standard Configuration Parameters										
		I/O	Connector	Power On State	Full Scale Setting	Full Scale Setting	Full Scale Setting	Poll IO Instance Producer	Poll IO Instance Consumer	Poll IO State Transition	External Baud Rate
	D0	DeviceNet	5 Pin Micro	Idle	Count	Integer	6000h	2	7	Executing	500KB
	D1	DeviceNet	5 Pin Micro	Idle	Count	Integer	6000h	21	7	Executing	500KB
	D2	DeviceNet	5 Pin Micro	Idle	SCCM	Float	7FFFh	13	19	Executing	500KB
	D3	DeviceNet	5 Pin Micro	Idle	Count	Integer	6000h	22	7	Executing	500KB
	D4	DeviceNet	5 Pin Micro	Executing	Count	Integer	6000h	22	8	Executing	500KB
	D5	DeviceNet	5 Pin Micro	Idle	Count	Integer	6000h	6	8	Executing	500KB
	D6	DeviceNet	5 Pin Micro	Idle	Count	Integer	7FFFh	3	7	Executing	500KB
	D7	DeviceNet	5 Pin Micro	Idle	Count	Integer	7FFFh	6	8	Executing	500KB
	D8	DeviceNet	5 Pin Micro	Idle	Count	Integer	6000h	3	7	Executing	500KB
	D9	DeviceNet	5 Pin Micro	Executing	Count	Integer	6000h	2	7	Executing	500KB
	DA	DeviceNet	5 Pin Micro	Idle	Count	Integer	7FFFh	22	7	Executing	500KB
	DB	DeviceNet	5 Pin Micro	Idle	Count	Integer	6000h	22	8	Executing	500KB
	DC	DeviceNet	5 Pin Micro	Idle	Count	Integer	7FFFh	3	7	Idle	500KB
	DD	DeviceNet	5 Pin Micro	Executing	Count	Integer	7FFFh	22	8	Executing	500KB
DE	DeviceNet	5 Pin Micro	Executing	SCCM	Float	6000h	15	19	Executing	500KB	
DX	DeviceNet	5 Pin Micro	To be defined by CSR								
G2	Analog/RS485	9 Pin D	NA	NA	NA	NA	NA	NA	NA	NA	NA
XI. Customer Special Request	XXXX	Customer Special Request Number									
XII. Auto Shut-Off	A	Auto Shut Off (Included)									
	X	Auto Shut Off (Not Included)									
XIII. Auto Zero	A	Auto Zero (Included)									
	X	Auto Zero (Not Included)									
XIV. Reference Temperature	000	0°C Reference Calibration (Standard) - Default Setting									

Example Model Code

I	II	III	IV	V	VI	VII	VIII	IX	X	XI	XII	XIII	XIV
GF	135	X	XX	C	XXXX XXXX	VX	A	O	D1	XXXX	A	A	000

Table 5-4 GF101, GF121 & GF126 Series Product Description Code

Code Description	Code Option	Option Description									
I. Base Model Code	GF	High Purity/Ultra High Purity Digital Mass Flow Controllers									
II. Package / Finish Specifications	101	Flow range 55 - 300 slm N ₂ Eq.; 10 Ra HP wetted flow path									
	121	Flow range 55 - 300 slm N ₂ Eq. 5 Ra UHP wetted flow path									
	126	Flow range 55 - 300 slm N ₂ Eq. 5 Ra UHP wetted flow path & integrated pressure measurement									
III. Configurability	C	MultiFlo capable									
	X	Not configurable									
IV. Special Application	XX	Standard									
V. Valve Configuration	C	Normally Closed valve									
	M	Meter (No Valve)									
VI. Gas or SH MultiFlo Bin	XXXX XXXX	Specific Gas Code & Range, i.e. "0004" = Argon and "100L" = 100 slpm									
	SH51 055L	Standard Configuration #51, 55,001 sccm N ₂ Equivalent (0°C Reference) Special Bin for low density gases, e.g. 73,002-120,000 He, 100,002-170,000 H ₂									
	SH52 100L	Standard Configuration #52, 55,002-100,000 sccm N ₂ Equivalent (0°C Reference)									
	SH53 200L	Standard Configuration #53, 100,001-200,000 sccm N ₂ Equivalent (0°C Reference)									
	SH54 300L	Standard Configuration #54, 200,001-300,000 N ₂ Equivalent (0°C Reference)									
VII. Fitting	V1	1-1/2" body width, 134mm 1/2" VCR male (See Accessories on Page 3 for VCR lay length adapters)									
	V2	1-1/2" body width, 150.4mm 1/2" VCR male									
	V3	1-1/2" body width, 166mm 1/2" VCR male									
	V4	1-1/2" body width, 168.6mm 1/2" VCR male									
	C1	1-1/2" body width, 92mm 3/8" C Seal									
	C2	1-1/2" body width, 114mm 3/8" C Seal									
VIII. Downstream Condition	A	Atmosphere									
	V	Vacuum									
IX. Sensor	O	Default Sensor Orientation									
X. Connector	BX	Cable adapter to 15 pin D Brooks (Unit "B", "N")									
	EX	Cable adapter to card edge (w/out VTP), RS485 through RJ11 jacks (Unit "E"; IN "L", "R"); display and overlay 180° orientation									
	FX	Cable adapter with 9 pin STEC pin-out & jack screws (w/VTP) (Unit "F", "O")									
	G1	9-Pin D with RS485 (Unit "G")									
	JX	Cable adapter with 9 pin STEC pin-out & jack screws (w/VTP) (Unit "J", "W")									
	KX	Cable adapter to MKS 15-Pin D (Unit "K")									
	SX	9 pin D with STEC pin-out (w/VTP) (Unit "S", "Q")									
	UX	Cable adapter to 15 pin D (w/VTP) (Unit & TN "U")									
		DeviceNet Standard Configuration Parameters									
		I/O	Connector	Power On State	Full Scale Setting	Full Scale Setting	Full Scale Setting	Poll IO Instance Producer	Poll IO Instance Consumer	Poll IO State Transition	External Baud Rate
	D0	DeviceNet	5 Pin Micro	Idle	Count	Integer	6000h	2	7	Executing	500KB
	D1	DeviceNet	5 Pin Micro	Idle	Count	Integer	6000h	21	7	Executing	500KB
	D2	DeviceNet	5 Pin Micro	Idle	SCCM	Float	7FFFh	13	19	Executing	500KB
	D3	DeviceNet	5 Pin Micro	Idle	Count	Integer	6000h	22	7	Executing	500KB
	D4	DeviceNet	5 Pin Micro	Executing	Count	Integer	6000h	22	8	Executing	500KB
	D5	DeviceNet	5 Pin Micro	Idle	Count	Integer	6000h	6	8	Executing	500KB
	D6	DeviceNet	5 Pin Micro	Idle	Count	Integer	7FFFh	3	7	Executing	500KB
	D7	DeviceNet	5 Pin Micro	Idle	Count	Integer	7FFFh	6	8	Executing	500KB
	D8	DeviceNet	5 Pin Micro	Idle	Count	Integer	6000h	3	7	Executing	500KB
	D9	DeviceNet	5 Pin Micro	Executing	Count	Integer	6000h	2	7	Executing	500KB
	DA	DeviceNet	5 Pin Micro	Idle	Count	Integer	7FFFh	22	7	Executing	500KB
	DB	DeviceNet	5 Pin Micro	Idle	Count	Integer	6000h	22	8	Executing	500KB
	DC	DeviceNet	5 Pin Micro	Idle	Count	Integer	7FFFh	3	7	Idle	500KB
	DD	DeviceNet	5 Pin Micro	Executing	Count	Integer	7FFFh	22	8	Executing	500KB
	DE	DeviceNet	5 Pin Micro	Executing	SCCM	Float	6000h	15	19	Executing	500KB
	DX	DeviceNet	5 Pin Micro	To be defined by CSR							
	XI. Customer Special Request	XXXX	Customer Special Request Number								
XII. Auto Shut-Off	A	Auto Shut-Off (Included)									
	X	Auto Shut-Off (Not Included) (Must be selected for meter)									
XIII. Auto Zero	A	Auto Zero (Included)									
	X	Auto Zero (Not Included)									
XIV. Reference Temperature	000	0°C Reference Calibration (Standard) - Default Setting									

Sample Standard Model Code

I	II	III	IV	V	VI	VII	VIII	IX	X	XI	XII	XIII	XIV
GF	101	C	XX	C	- SH52 100L	- V1	A	0	G1	- XXXX	A	X	- 000

GF100 Series

Table 5-5 GF101, GF121 & GF126 Series with EtherCAT Communications Product Description Code

Code Description	Code Option	Option Description
I. Base Model Code	GF	High Purity/Ultra High Purity Digital Mass Flow Controllers
II. Package / Finish Specifications	101	Flow range 55 - 300 slm N2 Equivalent.; 10 Ra HP wetted flow path
	121	Flow range 55 - 300 slm N2 Equivalent 5 Ra HP wetted flow path
	126	Flow range 55 - 300 slm N2 Equivalent 5 Ra HP wetted flow path & integrated pressure measurement
III. Configurability	C	MultiFlo capable. Standard bins or specific gas/range may be selected
	X	Not MultiFlo capable. Specific gas/range required
IV. Special Application	XX	Standard
V. Valve Configuration	C	Normally Closed valve
	M	Meter (No Valve)
VI. Gas or SH MultiFlo Bin	XXXX XXXX	Specific Gas Code & Range, i.e. "0004" = Argon and "010L" = 10 slpm
	SH51 055L	Standard Configuration #51, 55,001 sccm N2 Equivalent (0°C Reference)
	SH52 100L	Standard Configuration #52, 55,002-100,000 sccm N2 Equivalent (0°C Reference)
	SH53 200L	Standard Configuration #53, 100,001-200,000 sccm N2 Equivalent (0°C Reference)
	SH54 300L	Standard Configuration #54, 200,001-300,000 N2 Equivalent (0°C Reference)
VII. Fitting	V1	1-1/2" body width, 134mm 1/2" VCR male
	C1	1-1/2" body width, 92mm C Seal
	C2	1-1/2" body width, 114mm C Seal
VIII. Downstream Condition	A	Atmosphere
	V	Vacuum
IX. Sensor	O	Default Sensor Orientation
X. Connector	E0	EtherCAT Communication
XI. Customer Special Request	XXXX	Customer Special Request (CSR) Number
XII. Auto Shut-Off	A	Auto Shut-Off (Included)
	X	Auto Shut-Off (Not Included)
XIII. Auto Zero	X	Auto Zero (Not Included)
XIV. Reference Temperature	000	0°C Reference Calibration (Standard) - Default Setting

GF100 Series Ordering Instructions

Refer to the Product Description Codes on the previous pages. Starting from the left, choose the product code options as follows:

1. Required performance model.
 - a. Standard Performance, non-PTI: **GF100**
 - b. High Performance, non-PTI: **GF120**
 - c. High Performance, w/ PTI: **GF125**
 - d. High Performance, w/ PTI, w/ROD: **GF135**
 - e. Standard Performance, High Flow, Non-PTI: **GF101**
 - f. High Performance, High Flow, Non-PTI: **GF121**
 - g. High Performance, High Flow, w/PTI: **GF126**
2. Configurability
 - a. Disabled: **X**
 - b. Enabled: **C**, Standard (not an option for GF135)
3. Specialty Application
 - a. Safe Delivery, for GF120 only: **SD**
 - b. No Specialty App: **XX**
4. Valve Configuration
 - a. Normally Closed: **C**
 - b. Normally Open: **O**
 - c. Meter: **M**
5. Gas or SH MultiFlo Bin
 - a. If Gas Specific, enter SEMI gas code: ex. **0013**, for N₂
 - b. If SH MultiFlow Bin: **SHnn**, nn being the required SHBin, 40 - 50 or 51 - 54 (High Flow)
6. Maximum Flow
 - a. If Gas Specific, enter maximum range in sccm, "C" or slm "L": ex. **500C**
 - b. If SH Bin, enter defined maximum flow: ex. **860**, choosing SH44, 281 - 860 sccm
7. Fitting
 - a. Enter 2-character option code as defined: ex. **CX**, 1 1/8" C Seal 92mm
8. Downstream Condition
 - a. Outlet to Vacuum: **V**
 - b. Outlet to Atmosphere: **A**
9. Sensor
 - a. Orthogonal: **O**, this is default, non-selectable
10. Connector
 - a. Enter 2-character option code as defined: ex. **DX**, DeviceNet
11. CSR
 - a. Customer Special Requirement, contact Brooks Apps Engineering for review of requirement and creation of CSR: **nnnn**
 - b. If DNET connector, CSR required to define DNET attributes: **0924**, generic, ODVA Std. configuration
 - c. None Required: **XXXX**
12. Auto Shut-Off.
 - a. Enabled: **A**
 - b. Disabled: **X**
13. Auto Zero
 - a. Disabled: **X**
14. Reference Temperature, Operating Temperature in Degrees C
 - a. 0°C Reference Calibration (Standard): **000**, default

Here is an example of a configured Product Description Code (PDC) for a GF125, Configurable, no Specialty Application, Valve Normally Closed, MultiFlo for 281-860 sccm, 1 1/8" C Seal 92mm, outlet to Vacuum, default sensor, DNET, no CSR, Auto Shut Off enabled, Auto Zero disabled and Default Reference Temperature:
GF125CXXC-SH44860C-CXVODX-0924AX-000

*THIS PAGE WAS
INTENTIONALLY
LEFT BLANK*

B-1 GF100 Series Patents

The GF100 Series may be protected by the following US patents and their international filings.

Table B-1 GF100 Series Patents

Patent/Pub. No.	Title
6343617	System and method of operation of a digital mass flow controller
6389364	System and method for a digital mass flow controller
6425281	Pressure insensitive gas control system
6445980	System and method for a variable gain proportional-integral (PI) controller
6539792	Method and apparatus for balancing resistance
6640822	System and method of operation of a digital mass flow controller
6681787	System and method of operation of a digital mass flow controller
6714878	System and method for a digital mass flow controller
6752166	Method and apparatus for providing a determined ratio of process fluids
6826953	Flow sensor
6845659	Variable resistance sensor with common reference leg
6910381	System and method of operation of an embedded system for a digital capacitance diaphragm gauge
6941965	Method and apparatus for providing a determined ratio of process fluids
6962164	System and method for a mass flow controller
7043374	Flow sensor signal conversion
7073392	Methods and apparatus for pressure compensation in a mass flow controller
7082824	Variable resistance sensor with common reference leg
7113895	System and method for filtering output in mass flow controllers and mass flow meters
7114511	System and method for a mass flow controller
7133785	Valve control system and method
7143774	Method and apparatus for providing a determined ratio of process fluids
7150201	System and method for measuring flow
7216019	Method and system for a mass flow controller with reduced pressure sensitivity
7231931	System and method for a mass flow controller
7243035	System and method for mass flow detection device calibration
7272512	Flow sensor signal conversion
7273063	Methods and apparatus for pressure compensation in a mass flow controller
7287434	System and method for measuring flow
7360551	Method and apparatus for providing a determined ratio of process fluids
7363182	System and method for mass flow detection device calibration
7380564	System and method for a mass flow controller
7409871	Mass flow meter or controller with inclination sensor
7412986	Method and system for flow measurement and validation of a mass flow controller
7424894	Method and apparatus for providing a determined ratio of process fluids
7434477	Methods and apparatus for pressure compensation in a mass flow controller

GF100 Series

*THIS PAGE WAS
INTENTIONALLY
LEFT BLANK*

Bulgarian

**Основни инструкции
Прочетете преди работа!**

Brooks Instrument проектира, произвежда и тества продуктите си по такъв начин, че те да отговарят на многобройни национални и международни стандарти. Тези оборудвания трябва правилно да се инсталират, експлоатират и поддържат за да се гарантира, че ще могат да работят съответно на техните нормални спецификации. Следващите инструкции трябва да се спазват и трябва да се включат в програмата за безопасност на труда при инсталирането, експлоатацията и поддръжката на продуктите на Brooks Instrument.

- За да се гарантира характерната производителност, инсталирането, експлоатацията, актуализирането, програмирането и поддръжката на продукта трябва да се извършват само от квалифициран персонал.
- Прочетете всички инструкции преди инсталирането, експлоатацията и поддръжката на продукта. Ако това ръководство не е съответстващото издание, вижте на задната обложка информацията за контакт с местния търговски офис. Запазете това ръководство за по-късно информиране.

▲ ВНИМАНИЕ: Не работете с оборудването извън диапазоните, указани в инструкцията и ръководството по експлоатация. Неизпълнението на това може да доведе до сериозни телесни повреди и / или повреждане на оборудването.

- Ако не разбирате някои инструкциите, свържете се с представителя на Brooks Instrument за изясняване на проблема.
- Спазвайте всички предупреждения, призови и инструкции означени върху оборудването или доставени заедно с него.

▲ ПРЕДУПРЕЖДЕНИЕ: Преди инсталацията се убедете, че този инструмент притежава необходимите одобрения за съответствие на местните и националните кодове. Неспазването на това предупреждение може да доведе до сериозни травми и/или повреда на оборудването.

- Инсталирайте оборудването съответно на указанията в инструкцията за инсталиране и на действащите на местни и национални предписания. Свързвайте продуктите само към подходящи източници на електричество и налягане.
- Ход: (1) Бавно въведете системата под налягане. Бавно отворете работните клапани за да се избегнат колебанията на потока. (2) Проверете дали няма изтичане при входното и изходното съединение на разходомера. Ако няма изтичане, напълнете системата до работно налягане.
- Преди извършване на поддръжката непременно проверете дали работният тръбопровод не се намира под налягане. Ако са необходими резервни части, с определените от Brooks Instrument резервни части трябва да борави само квалифициран персонал. Неразрешените части и процедури могат да окажат влияние върху работата на продукта, и също да застрашат безопасността на експлоатацията. Заместването с неоригинални части може да доведе до пожар, опасност от токов удар или неправилна работа.
- Всички врати на оборудването непременно да бъдат затворени, а защитните покрития да бъдат на мястото си, за да се избегнат токовите удари и телесните повреди, освен ако квалифицирани специалисти извършват работи по неговото поддръжане.

▲ ВНИМАНИЕ: При оборудванията с протичащи течности, ако по някаква причина е необходимо да се затворят намиращите се до оборудването изходни и входни клапани, оборудването трябва напълно да се изпразни. Неизпълнението на това може да причини топлинно разширение на течността, което може да спуска оборудването и да доведе до телесни повреди.

Европейска директива за уреди под налягане (PED)

Всички съоръжения под налягане с вътрешно налягане над 0,5 bar (g) и с размер по-голям от 25 mm или 1" (inch), попадат под действието на европейската директива за уреди под налягане (PED).

- Глава „Технически данни“ на настоящото ръководство съдържа свързаните с директивата PED инструкции.
- Указаните в настоящото ръководство продукти съответстват на европейската директива 2014/34/EU.
- Всички разходомери на Brooks Instrument се отнасят към флуиди от група 1.
- Продуктите по-големи от 25 mm или 1" (inch) съответстват на I, II или III категория според PED.
- Продуктите с размери 25 mm или 1" (inch), или по-малки, следват добрата инженерна практика (SEP).

Европейска директива за електромагнитна съвместимост (EMC)

Носещото знака CE (електрическо/електронно) оборудване на Brooks Instrument е изпълнило успешно тестовете за проверка на изискванията за електромагнитна съвместимост (директива EMC 2014/30/EU).

Особено внимание трябва да се обърща обаче на избирането на сигналните кабели, използвани с оборудването, носещо знака CE.

Качество на сигналните кабели, кабелните салници и съединители:

Brooks Instrument предлага висококачествени кабели, отговарящи на изискванията на CE сертификацията.

Ако използвате собствен сигнален кабел, трябва да изберете такъв, който е напълно защитен със 100%-ово екраниране.

Съединителите тип „D“ или „кръгов“ трябва да бъдат екранирани с метален щит. При необходимост за фиксирането на щита на кабела трябва да се използват метални кабелни салници.

Щитът на кабела трябва да се свърже с металното покритие или металния салник и в двата края да се екранира в 360°. Щитът трябва да бъде заземен.

Съединителите за печатни платки са стандартно неметални. Използваните кабели трябва да бъдат защитени със 100%-ово екраниране, за да отговарят на CE сертификацията.

Щитът трябва да бъде заземен.

Конфигурация на контактите: Виж приложената инструкция за експлоатация.

Електростатичен разряд (ESD)

▲ ВНИМАНИЕ: Приборът съдържа електронни компоненти, които са чувствителни към статичното електричество и могат да се повредят от него. Трябва да се спазват съответните процедури по време на изваждане, слагане или друго боравене с вътрешните монтажни платки и устройства.

Процедура за работа:

1. Изключете оборудването.
2. Персоналът трябва да се заземи с гривна или друго безопасно и подходящо за целта средство, преди да инсталира, изважда или регулира монтажна платка или друго вътрешно устройство.
3. Печатните монтажни платки трябва да се транспортират в проводяща опаковка. Печатните платки могат да се изваждат от защитното покритие само непосредствено преди инсталирането. Отстранените печатни платки незабавно трябва да се сложат в защитна опаковка, служеща за транспортиране, складиране или връщане на производителя.

Забележки:

Не е уникално явление, че този прибор съдържа чувствителни към електростатичния заряд (ESD) компоненти. Болшинството от съвременните електронни прибори съдържат компоненти, изготвени по технологията метал-окис (NMOS, SMOS и т.н.). Опитът доказва, че даже и малко количество статическо електричество може да повреди или съсипе тези прибори. Повредените компоненти даже ако привидно работят правилно, проявяват начални неизправности.

GF100 Series

Czech

Základní instrukce

Před instalací si přečtěte následující instrukce!

Společnost Brooks Instrument konstruuje, vyrábí a testuje tento produkt tak, aby splnil mnoho národních a mezinárodních standardů. Přístroje musí být řádně nainstalovány, používány a udržovány tak, aby byl zajištěn jejich nepřetržitý provoz v rámci normálních technických specifikací. Musíte dodržovat následující pokyny a integrovat jejich obsah do svého bezpečnostního programu při instalování, používání a udržování produktů společnosti Brooks.

- Pro zajištění správné funkce zařízení mohou jeho instalaci, obsluhu, programování, údržbu a aktualizace firmwaru provádět výhradně kvalifikované osoby.
- Před instalací, provozem a údržbou produktu si prostudujte všechny pokyny. Pokud tato příručka není tou správnou příručkou pro dané zařízení, informujte se na zadní straně obálky o kontaktu na místní prodejní kancelář. Uchovejte si tuto příručku pro pozdější potřebu.

⚠ UPOZORNĚNÍ: Neprovazujte zařízení v rozsahu mimo daný rozsah v provozní příručce. Porušení tohoto upozornění může mít za následek vážné újmy na zdraví a vést k poškození zařízení.

- Pokud některým pokynům nerozumíte, kontaktujte svého prodejního zástupce společnosti Brooks a vyžádejte si objasnění.
- Dodržujte všechny výstrahy, upozornění a pokyny, uvedené a vyznačené na produktu, nebo s ním dodané.

⚠ VAROVÁNÍ: Před instalací proveďte, zda má tento přístroj požadované schválené parametry splňující místní a národní předpisy. Nedodržení tohoto varování může způsobit vážnou újmu na zdraví osob a/nebo poškození zařízení.

- Namontujte zařízení specifikovaným způsobem podle správné montážní příručky a podle platných místních a národních předpisů. Připojte všechny produkty ke správným zdrojům elektrické energie a stlačených médií.
- Postup: (1) Pomalu do systému přivádějte médium. Pro zabránění vzniku rázů v systému otvírejte procesní ventily postupně. (2) Překontrolujte těsnost vstupního a výstupního připojení průtokoměru. Pokud nezjistíte žádné netěsnosti, postupně zvedejte tlak na provozní hodnotu.
- Před prováděním servisních prací zkontrolujte, zda systém není pod tlakem. V případě potřeby výměny dílů zajistěte, aby byly použity náhradní součásti specifikované společností Brooks Instrument a výměnu prováděla kvalifikovaná osoba. Použití neschválených dílů a postupů může negativně ovlivnit efektivitu a bezpečnost procesu. Použití náhrad za originální díly může způsobit požár, úraz elektrickým proudem nebo nesprávnou funkci.
- Pokud není zrovna prováděna údržba kvalifikovanou osobou, ujistěte se, že zařízení je opatřeno všemi předepsanými kryty.

⚠ UPOZORNĚNÍ: Pokud je u zařízení s průtokem kapalin nutno z jakéhokoli důvodu uzavřít vstupní a výstupní ventily, je nutné zařízení kompletně vyprázdnit. Pokud tak neučiníte, může z důvodu teplotní roztažnosti zbytků média v zařízení dojít k jeho poškození nebo k ohrožení zdraví osob.

Evropská směrnice pro tlakové zařízení (PED)

Na veškerá tlaková zařízení s vnitřním tlakem vyšším než 0,5 baru (g) a velikosti větší než 25 mm nebo 1" (palec) se vztahuje platnost směrnice o tlakovém zařízení (PED).

Kapitola „Technické údaje“ v této příručce obsahuje důležité bezpečnostní a provozní pokyny související se směrnicí PED.

- Produkty popsané v této příručce jsou v souladu se směrnicí EN 2014/34/EU.
- Všechny průtokoměry společnosti Brooks Instrument spadají do rámce Kapaliny, skupina I.
- Produkty větší než 25 mm nebo 1" (palec) jsou v souladu se směrnicí PED, kategorií I, II nebo III
- Produkty s velikostí 25 mm nebo 1" (palec) a menší spadají do rámce Správných technických postupů (SEP).

Evropská směrnice pro elektromagnetickou kompatibilitu (EMC)

Elektrické/elektronické zařízení Brooks Instrument nesoucí značku CE bylo úspěšně testováno dle předpisů pro elektromagnetickou kompatibilitu (směrnice EMC č. 2014/30/EU).

Výběru signálních kabelů pro použití se zařízením označeným CE je nutné věnovat zvláštní pozornost.

Kvalita signálních kabelů, kabelových průchodků a konektorů:

Brooks Instrument dodává vysoce jakostní kabely splňující požadavky kvalitativního zařazení CE. Pokud chcete použít vlastní signální kabely, zvolte typy s kvalitním stíněním všech žil a v celé délce trasy.

V případě použití konektorů kruhových nebo tvaru „D“, musí mít tyto kovové stínění. V případě jejich použití, musí kovové kabelové průchodky být propojeny se stíněním kabelu.

Stínění by mělo být připojené ke kovovému tělesu přístroje nebo krytu, na obou koncích kabelu a po celém jeho obvodu.

Stínění by mělo být uzemněno.

Připojky vedoucí ke kartám podle norem jsou nekovové. Pro splnění požadavků předpisů CE musí být použité kabely kompletně stíněny.

Stínění by mělo být uzemněno.

Konfigurace kontaktů je uvedena v příloženém návodu k obsluze.

Elektrostatický výboj (ESD)

⚠ UPOZORNĚNÍ: Tento přístroj obsahuje komponenty citlivé na poškození statickou elektřinou. Při montáži, demontáži či jiné manipulaci s vnitřními elektronickými obvody je potřeba dodržovat příslušné postupy.

Postup ošetřování:

1. Odpojte přístroj od napájení.
2. Osoba provádějící údržbu má být při instalaci, vyjímání či práci na desce plošných spojů nebo jiné vnitřní elektronice uzemněna zemním náramkem, nebo jiným vyhovujícím způsobem.
3. Desky plošných spojů je nutné přepravovat v elektricky vodivém obalu. Plošné spoje vyjímajte z vodivého obalu až bezprostředně před instalací do přístroje! Plošné spoje vyjmuté z přístroje a určené pro další využití, opět neprodleně umístěte do ochranného obalu.

Poznámky:

Existence prvků, citlivé na elektrostatické výboje (ESD) v přístrojích je častým jevem. Prvky s technologií oxidu kovů (NMOS, SMOS) jsou používány u většiny moderních elektronických zařízení. Zkušenosti dokazují, že i jen malé elektrostatické výboje mohou poškodit nebo zničit tyto zařízení. U poškozených součástí, jakkoli zdánlivě pracujících bezchybně, dochází brzy k poruše.

Dansk

Grundlæggende vejledninger
Læs disse før anvendelse!

Brooks Instruments designer, fremstiller og afprøver sine produkter således, at de tilpasser sig både de indenrigs og internationale standarder. Disse udstyr bør installeres, bruges og reparerer omhyggeligt, så at de kan virke tilsvarende deres normale anvendelsesperiode. De følgende regler skal overholdes og implementeres under installationen samt ved brug og reparation.

- For at garantere den passende kapacitet, er udstyrets installation, anvendelse, opdatering, programmering kun tilladt for kvalificeret personale. Alle vejledninger skal læses før produktets installation, anvendelse og reparation.
- Hvis denne manual ikke er den passende udgave, kontakt venligst jeres leverandør for yderligere information.
- Det anbefales at gemme denne manual for senere brug.

▲ OBS.: Udstyret må ikke anvendes til andet end det er angivet i brugsanvisningen. Hvis denne regel brydes, kan der forekomme alvorlige personskader eller brist på udstyret.

Hvis vejledningerne ikke er forståelige, kontakt venligst Deres Brooks repræsentant for at afklare problemet som er opstået.

- Overhold alle regler, som er markeret eller leveret sammen med udstyret.

▲ ADVARSEL! Før ibrugtagning/installation skal det kontrolleres, at det ihåndenværende instrument opfylder de lokale og nationale sikkerhedskrav. Hvis denne advarsel ignoreres, kan det resultere i alvorlig personskade og/eller skader på instrumentet.

- Installer udstyret efter den angivne installationsvejledning og gældende lovgivning for anvendelsesområde. Udstyret må kun tilsluttes med kabler og stik som overholder kravspecifikationerne i vejledningen.
- Ibrugtagning: (1) Åbn langsomt for trykket i systemet. Åbn langsomt for alle procesventiler for at forhindre ustabil gas flow. (2) Tjek systemet for lækage ved tilsluttet måleinstrumenter, samlinger og andet tilsluttet udstyr. Derefter øg trykket i systemet indtil arbejdstrykket er opnået.
- Før reparation tjek altid at procesledningen ikke står under tryk. Hvis der er brug for at udskifte defekte dele må kun kvalificeret personale udføre arbejdet og af sikkerhedsmæssige årsager må der kun anvendes originale Brooks reservedele. Det er ikke tilladt at anvende reservedele eller udføre arbejde der på nogen måde kan ændre produktet fra dens oprindelige specifikationer. Manglende overholdelse af de foreskrevne procedurer kan resultere i brænd, og fare for elektrisk stød eller kortslutning.
- Af sikkerhedsmæssige årsager sørg for at alle sikkerhedsforanstaltninger er overholdt. Eksempelvis at alle afskærmninger eller anden form for installationsbeskyttelse er lukket eller installeret ved normal drift.

▲ Advarsel.: Ved brug af udstyr som anvendes til væske skal det sikres at indgangsventilen og udgangsventilen ikke bliver lukket på samme tid i forbindelse med aftapning. Såfremt dette ikke overholdes, er der risiko for at væsken på grund af varmeudvikling ekspanderer og dette kan forårsage skade på udstyr og personer.

Det Europæiske direktiv for trykudstyr (PED)

På alt udstyr hvis indgangstryk er større end 0,5bar (g) og større end 25 mm eller en tomme, gælder det europæiske direktiv for trykapparater. Manualens afsnit "tekniske data" indeholder anvisninger om PED direktivet.

- I manualen angives instrumenter der er tilpasset direktiv 2014/34/EU.
- Alle Brooks gennemstrømningsmålere tilhører væskegruppe nr. 1.
- Alle instrumenter som er større end 25 mm eller en tomme beskrives i direktivet PED's kategorier I, II eller III.
- Alle instrumenter som er på 25 mm eller en tomme, eller mindre, beskrives i Sound Engineering Practice (SEP).

Det europæiske direktiv for elektromagnetisk kompatibilitet (EMC)

Alle Brooks instrumenter (elektrisk/elektronisk) som har CE markering er godkendt og testet ifølge om elektromagnetiske kompatibilitets forskrifter (EMC direktiv 2014/30/EU).

OBS: Man skal være opmærksom på hvilken type kabler der bruges til CE mærket udstyr..

Om kvalitet af signalkabler, kabeltilslutninger og koblinger:

Brooks tilbyder kabler af højest kvalitet, som er tilpasset CEE kvalificeringens forskrifter. Hvis man vælger at bruge egne kabler, skal man vælge et kabel som har den nødvendige afskærmning for at sikre 100 % mod udefra kommende støj.

Tilslutningerne "D" eller rundformede tilslutninger skal være afskærmet med skal af metal.

Stikket skal være afskærmet på alle sider. Al afskærmning skal jordes..

Card Edge tilslutninger er ifølge standarden ikke metalliske.. De anvendte kabler og stik skal være 100 % afskærmet for at opfylde CE kravene.. De skal ligeledes jordes.

For stik konfigurationen se vedlagte brugsvejledning.

Elektrostatisk afladning (ESD)

▲ OBS.: Udstyret indeholder tilbehør som kan skades ved elektrostatisk elektricitet. Alle forskrifter skal overholdes ved kontakt med alle elektriske komponenter både under drift og vedligeholdelse..

Behandlingsproceduren:

1. Sluk for al strømtilførsel til udstyret.
2. Personer som skal i kontakt med udstyret skal være jordet eller bære anden form for elektrisk beskyttende udstyr. Manglende overholdelse af dette kan medføre skader på alle elektriske komponenter.
3. Alle elektriske komponenter skal opbevares eller transporteres i deres originale indpakning for at sikre komponenter mod statiske elektriske skader. Emballagen må ikke åbnes før komponenten skal installeres i udstyret. Ved afslutning af vedligeholdelse/reparation af udstyret, skal udstyret installeres med det samme eller pakkes forsvarligt hvis det skal på lager eller transporteres.

Bemærkninger:

Dette udstyr er ikke unik i den hensigt, at det indeholder for elektrostatisk afladning (ESD) sensitive reservedel. I de fleste elektronisk udstyr findes der metaloxyd teknologiske reservedel (NMOS, SMOS m.m.). Erfaringerne viser at selv den mindste statiske elektricitet kan skade, eller ødelægge disse instrumenter. Selv en fungerende elektrisk del kan have levetiden markant reduceret på grund af statisk elektricitet..

GF100 Series

Dutch

Essentiële instructies

Lees ze voordat u verder gaat!

Brooks Instrument ontwerpt, produceert en test haar producten zodanig dat ze voldoen aan vele nationale en internationale normen. Deze producten moeten correct worden geïnstalleerd, bediend en onderhouden zodat ze binnen hun normale specificaties blijven werken. De volgende instructies moeten worden toegevoegd aan en geïntegreerd in uw veiligheidsprogramma als u producten van Brooks Instrument installeert, bedient en onderhoudt.

- Om de juiste prestaties te kunnen garanderen mag alleen gekwalificeerd personeel het product installeren, bedienen, updaten, programmeren en onderhouden.
- Lees alle instructies voordat u het product gaat installeren, bedienen en onderhouden. Als dit niet de juiste handleiding is, kijk dan op de achterzijde voor contactinformatie van uw vertegenwoordiger. Bewaar deze handleiding voor later.

▲ WAARSCHUWING: gebruik dit instrument niet als niet is voldaan aan de specificaties in de handleiding. Het niet naleven van deze waarschuwing kan ernstig letsel en/of schade aan de apparatuur tot gevolg hebben.

- Als u één of meer instructies niet begrijpt, vraag dan om uitleg aan uw vertegenwoordiger van Brooks Instrument.
- Neem alle waarschuwingen, voorschriften en instructies in acht die op het product zijn aangebracht of bij het product zijn geleverd.

▲ WAARSCHUWING: Zorg ervoor dat dit instrument de vereiste goedkeurings-classificatie heeft om te voldoen aan de lokale en nationale standaarden, voordat u het gaat installeren. Het niet naleven van deze waarschuwing kan ernstig letsel en/of schade aan de apparatuur tot gevolg hebben.

- Installeer uw apparatuur volgens de instructies in de bijgeleverde handleiding en in overeenstemming met de geldende lokale en nationale voorschriften. Sluit alle producten aan op de juiste elektrische voedings- en drukbronnen.
- Bediening: (1) Laat het systeem langzaam langzaam volstromen. Open de procesafsluiters langzaam om drukstoten te voorkomen. (2) Controleer op lekkages rondom de inlaat- en uitlaataansluitingen van de stromingsmeter. Als er geen lekkages zijn, kan het systeem op de bedrijfsdruk worden gebracht.
- Zorg ervoor dat de procesleiding drukvrij is gemaakt voordat u servicewerkzaamheden gaat uitvoeren. Als vervangingsonderdelen nodig zijn, zorg er dan voor dat gekwalificeerd personeel de door Brooks Instrument gespecificeerde vervangingsonderdelen gebruikt. Niet goedgekeurde onderdelen en procedures kunnen de prestaties van het product en de veilige werking van uw proces in gevaar brengen. Niet goedgekeurde vervangingsonderdelen kunnen brand, elektrische schokken of een onjuiste werking tot gevolg hebben.
- Zorg ervoor dat alle deksels van de apparatuur gesloten zijn en de afdekkingen gemonteerd zijn om elektrische schokken en lichamelijk letsel te voorkomen, behalve als gekwalificeerd personeel de onderhoudswerkzaamheden uitvoert.

▲ WAARSCHUWING: bij vloeistofstroomapparaten waarvan de inlaat- en uitlaatkleppen om welke reden dan ook gesloten zijn, moet de vloeistof volledig worden afgetapt. Als dat wordt nagelaten, kan dit leiden tot thermische expansie van de vloeistof waardoor het apparaat kan barsten en lichamelijk letsel kan veroorzaken.

PED (Pressure Equipment Directive)

Alle drukapparatuur met een interne druk van meer dan 0,5 barg en een diameter van meer dan 25 mm valt onder de PED-richtlijn.

- In het hoofdstuk Specificaties van deze handleiding staan aanwijzingen die verband houden met de PED-richtlijn.
- De producten die in deze handleiding worden beschreven, voldoen aan de Europese richtlijn 2014/34/EU.
- Alle stromingsmeters van Brooks Instrument vallen in groep 1.
- Producten met een diameter van meer dan 25 mm voldoen aan de categorieën I, II of III van de PED-richtlijn.
- Producten met een diameter van 25 mm of kleiner voldoen aan de regels van goed vakmanschap.

Elektromagnetische compatibiliteit (EMC)

De elektronische apparatuur van Brooks Instrument met de CE-markering is succesvol getest in overeenstemming met de EMC-voorschriften (richtlijn EMC 2014/30/EU).

De keuze van de signaalkabel voor gebruik in combinatie met apparatuur met CE-markering verdient speciale aandacht.

Kwaliteit van de signaalkabel, kabelafdichtingen en stekkers:

Brooks Instrument levert hoogwaardige kabels die voldoen aan de specificaties voor de CE-markering.

Als u zelf voor signaalkabel zorgt, moet u altijd een volledig afgeschermd kabel gebruiken.

Stekkers van het type "D" of ronde stekkers moeten zijn voorzien van een metalen afscherming. Indien nodig moeten metalen kabelafdichtingen worden gebruikt waarvan de afscherming voor het klemmen van de kabel kan worden gebruikt.

Het kabelscherm moet met het metalen omhulsel of de metalen afdichting worden verbonden en aan beide uiteinden rondom volledig worden afgeschermd.

De afscherming moet aan de aardpotentiala worden aangesloten.

Card Edge Connectors zijn standaard niet van metaal. De gebruikte kabels moeten volledig zijn afgeschermd om te voldoen aan de CE-markering.

De afscherming moet aan de aardpotentiala worden aangesloten.

Voor de pinconfiguratie: Raadpleeg de bijgevoegde handleiding.

Elektrostatische ontlading

▲ VOORZICHTIG: Dit instrument bevat elektronische componenten die gevoelig zijn voor statische elektriciteit. Neem de juiste procedures in acht bij het verwijderen en installeren of bij andere werkzaamheden aan de interne printplaten of apparaten.

Procedure:

1. Schakel de voeding van de eenheid uit.
2. Het personeel moet zich met een polsbandje of ander veilig en geschikt hulpmiddel aarden voordat een printplaat of ander intern apparaat mag worden geïnstalleerd, verwijderd of aangepast.
3. Printplaten moeten in een geleidende verpakking worden vervoerd. De platen mogen pas vlak voor de eigenlijke installatie uit de beschermende verpakking worden gehaald. Verwijderde printplaten moeten onmiddellijk in de beschermende verpakking worden geplaatst om te worden getransporteerd, opgeslagen of teruggestuurd naar de fabriek.

Opmerkingen

Dit instrument is niet uniek als het gaat om componenten die gevoelig zijn voor elektrostatische ontlading. De meeste moderne elektronische apparaten bevatten componenten die gebruik maken van de metaaloxidede technologie (NMOS, SMOS, enz.). Uit ervaring blijkt dat zelfs kleine hoeveelheden statische elektriciteit deze apparaten al dan niet onherstelbaar kunnen beschadigen. Beschadigde componenten, zelfs als ze goed lijken te functioneren, raken eerder defect.

Estonian

Olulised juhised Enne kasutamist lugege hoolikalt läbi!

Brooks Instrument konstrueerib, valmistab ja katsetab oma tooteid selliselt, et need vastaksid paljudele riiklikele ja rahvusvahelistele standarditele. Ainult nõuetekohane paigaldamine, kasutamine ja hooldamine tagab toodete katkematu talitluse tavaspetsifikatsiooni raames. Brooks Instrumenti toodete paigaldamisel, kasutamisel ja hooldamisel tuleb täita alljärgnevat juhiseid ja integreerida need asjakohasesse ohutusprogrammi.

- Nõuetekohase talitluse tagamiseks tohib toodet paigaldada, kasutada, täiustada, programmeerida ja hooldada ainult kvalifitseeritud personal.
- Enne toote paigaldamist, kasutamist ja hooldamist lugege kõik kasutusjuhised hoolikalt läbi. Kui see kasutusjuhend ei vasta teie tootele, pöörduge kohaliku edasimüüja poole, kelle kontaktandmed leiab kasutusjuhendi tagakaanelt. Hoidke see kasutusjuhend edaspidiseks alles.
▲ **HOIATUS. Ärge kasutage seda instrumenti väljaspool kasutusjuhendis spetsifitseeritud piirväärtusi. Hoiatuse eiramine võib kaasa tuua raske kehavigastuse ja/või kahjustada seadet.**
- Kui te saa mõne juhise mõttest aru, pöörduge selgituste saamiseks kohaliku Brooks Instrumenti edasimüüja poole.
- Järgige kõiki hoiatusi, tähelepanule manitsusi ja juhiseid, mis on tootele peale kantud või tootega kaasa antud.
▲ **HOIATUS. Enne paigaldamist veenduge, et see instrument vastaks kohalike ja riiklike määrustega kehtestatud nimiaandmetele. Hoiatuse eiramine võib kaasa tuua raske kehavigastuse ja/või kahjustada seadet.**
- Seadme paigaldamisel järgige vastavas kasutusjuhendis toodud paigaldusjuhiseid ning asjakohaseid kohalikke ja riiklikke eeskirju. Ühendage tooted nõuetekohaste toite- ja surveallikatega.
- Talitus. (1) Avage aeglaselt vool süsteemi. Vooluimpulsside vältimiseks avage tööventiilid aeglaselt. (2) Kontrollige, et voolukulumõõtri sisend- või väljundühenduste ümber ei oleks lekkeid. Kui lekkeid ei ole, laske süsteemil saavutada töösurve.
- Enne seadme hooldamist veenduge, et kogu süsteem oleks surve alt vabastatud. Varuosasid tohib vahetada ainult kvalifitseeritud personal, kasutades selleks Brooks Instrumenti heakskiidetud varuosi. Mitteoriginaalvaruosade kasutamine ja ebapädev toimingute tegemine võivad kahjustada toote tööomadusi ja põhjustada riski tootmistegevuse ohutuse tagamisel. Originaalvaruosadele sarnaste osade kasutamine võib põhjustada tule- või elektrilöögiohtu või seadme väärtalitlust.
- Elektrilöögi- ja vigastuseohtu vältimiseks peavad seadme luugid olema alati suletud ja kaitsekatted oma kohal, v.a seadme hooldamisel kvalifitseeritud isikute poolt.
▲ **HOIATUS. Voolava vedelikuga seadmete kasutamisel – kui seadmega külgnevad sisend- ja väljundklapid on vaja mingil põhjusel sulgeda, tuleb seadmed vedelikust täiesti tühjaks lasta. Vastasel korral võib vedelik soojuse mõjul paisuda niivõrd, et seade puruneb. See võib põhjustada raskeid kehavigastusi.**

Euroopa surveseadmete direktiiv (PED)

Euroopa surveseadmete direktiiv kohaldub kõikidele surveseadmetele, mille sisesurve on üle 0,5 baari (g) ja läbimõõt üle 25 mm või 1 tolli.

- Selle kasutusjuhendi spetsifikatsiooniosa sisaldab surveseadmete direktiiviga seonduvat juhiseid.
- Kasutusjuhendis kirjeldatud tooted vastavad EL direktiivi 2014/34/EÜ nõuetele.
- Brooks Instrumenti voolukulumõõturid kuuluvad vedelike 1. gruppi.
- Tooted läbimõõduga üle 25 mm või 1 tolli vastavad surveseadmete direktiivi kategooriale I, II või III.
- Toodetele läbimõõduga alla 25 mm või 1 tolli kohaldatakse häid inseneritavasid.

Euroopa elektromagnetilise ühilduvuse direktiiv (EMÜ)

Brooks Instrumenti (elektrilised/elektroonilised) seadmed, millele on omistatud CE-tähis, on edukalt läbinud asjakohased katsed ja vastavad elektromagnetilise ühilduvuse nõuetele (EMÜ direktiiv 2014/30/EÜ).

Kuid signaalkaabli valimisel on vaja pöörata suurt tähelepanu CE-tähisega seadmetele.

Signaalkaabli, läbiviigutühendite ja konnektorite kvaliteet

Brooks Instrument turustab kõrgekvaliteedilisi kaableid, mis vastavad CE-sertifikaadi nõuetele.

Olemasoleva kaabli kasutamisel jälgige, et kaabel oleks täielikult ümbritsetud varjestusega.

„D“- või „Ring“-tüüpi konnektorid peavad olema varustatud metallvarjestusega. Võimaluse korral tuleb kasutada metallist läbiviike, mis tagavad kaabli varjestuse ühenduse.

Kaabli varjestus ühendatakse metallkesta või läbiviigutühendiga ja on mõlemast otsast kaitstud 360° ulatuses.

Varjestus peab olema maandatud.

Mikroskeemide servaühendused on üldjuhul mittemetallist. Vastavuse tagamiseks CE-sertifikaadi nõuetele peavad kasutatud kaablid olema 100% varjestatud.

Varjestus peab olema maandatud.

Klemmide konfigureerimine: vt komplekti kuuluvat kasutusjuhendit.

Elektrostaatiline laeng

▲ **TÄHELEPANU!** Seade sisaldab staatilise elektri suhtes tundlike elektroonikakomponente. Seadmesse paigaldatud trükkplaatide eemaldamisel ja paigaldamisel, samuti trükkplaadi või seadmega muude toimingute teostamisel järgige nõuetekohase käsitsemise juhiseid.

Käsitsemisjuhised

1. Lahutage seade toiteallikast.
2. Enne trükkplaadi või mõne muu siselemendi paigaldamist, eemaldamist või konfigureerimist peab personal olema maandatud läbi randmepaela või mõne muu sobiva vahendi.
3. Trükkplaatide transporditakse voolujuhtivas konteineris. Võtke trükkplaat kaitsvast konteinerist välja vahetult enne selle paigaldamist. Seadme eemaldatud trükkplaadid tuleb viivitamatult asetada kaitsvasse konteinerisse, kas siis edasiseks transportimiseks, hoiustamiseks või tehasesse tagasisaatmiseks.

Kommentaariid

See seade ei ole ainus, mis sisaldab staatilise elektri suhtes tundlike elemente. Enamik kaasaegsetest elektroonikaseadmetest sisaldavad komponente, mille valmistamiseks on kasutatud metalloksiidtehnoloogiat (NMOS, SMOS jne). Kogemused näitavad, et isegi väike kogus staatilist elektrit võib neid seadmeid kahjustada või isegi hävitada. Kuigi võib näida, et kahjustatud komponendid töötavad nõuetekohaselt, hakkavad talitlushäired ilmema juba varakult.

GF100 Series

Finnish

Perusohjeet

Lue ensin ohjeet huolellisesti!

Brooks Instrument suunnittelee, valmistaa ja testaa laitteensa vastaamaan useimpien kotimaisten ja kansainvälisten standardien vaatimuksia. Tuotteet tulee asentaa, käyttää ja huoltaa käyttöohjeiden mukaan jotta niiden toimivuus taataan. Brooks Instrumentin laitteiden asennuksessa, käytössä ja huollossa on noudatettava soveltuvia määräyksiä ja ohjeita, lisäksi mainitut ohjeet on huomioitava työsuojelun ohjeistuksessa.

Oikean toiminnan varmistamiseksi vain valtuutettu huoltohenkilö saa asentaa, käynnistää, päivittää, ohjelmoida ja huoltaa laitteita. Lue kaikki käyttöohjeet koskien tuotteen asennusta, käyttöä ja huoltoa. Jos käyttöohje on puutteellinen, lisätietoja saa paikalliselta jälleenmyyjältä. Yhteystiedot löytyvät oppaan kansilehdestä. Säilytä ohjeet.

VAROITUS! Käyttöohjeessa ilmoitettujen standardien mukaisia ohjeita ja raja-arvoja ei saa ylittää. Rajoitusten laiminlyönti voi aiheuttaa tuotteen rikkoutumisen ja/tai vakavan henkilövahingon vaaraan.

- Jos ohjeissa on epäselvyyttä, ota yhteyttä Brooks Instrumentin edustajaan ongelman selvittämiseksi.
- Noudata kaikkia laitteessa olevia tai siihen liittyviä ohjeita, määräyksiä ja varoituksia.

VAROITUS! Tarkista ennen asennusta, että tällä laitteella on paikallisten ja maasi koodien mukaiset hyväksyntäluokitukset. Tämän varoituksen laiminlyönnistä saattaa aiheutua vakava vamma ja/tai laitevaurio.

- Laitteen asennuksessa on noudatettava erityisiä asennusohjeita sekä voimassa olevia paikallisia ja kansainvälisiä määräyksiä. Laitteet saa yhdistää vain sopivaan sähkö- ja paineverkkoon.
- Asennusohjeita: (1) Päästä virtaus hitaasti järjestelmään. Avaa venttiilit hitaasti, jotta virtaus pysyy tasaisena. (2) Tarkista, ettei virtausmittarin sisään- ja ulosmenon liitoksissa ole vuotoa. Jos järjestelmässä ei ole vuotoa, aseta oikea käyttöpaine.
- Tarkista, että laitteeseen menevä paine on katkaistu ennen laitteen korjaamista välttääksesi loukkaantumiseriskin. Mahdollisten varaosien tulee olla Brooks Instrumentin hyväksymiä. Vain valtuutettu huoltohenkilö saa asentaa varaosat. Ei-hyväksytyjen varaosien käyttö voi vahingoittaa tuotteen toimintaa ja aiheuttaa turvallisuusrisikin. Samoin ei-hyväksytyjen varaosien käyttö voi aiheuttaa tulipalon, sähköiskun tai virhetoiminnan riskin.
- Varmista että kaikki kaikki laitteen ovet/luukut ovat suljettuina ja tarkista että suojakannet ovat paikoillaan estääksesi mahdollisen sähköisku- ja loukkaantumisvaaran.

VAROITUS! Jos järjestelmässä virtaa neste ja laitteen sisään- ja ulosmenuventtiilit pitää sulkea, laite on ensin tyhjennettävä kokonaan. Tyhjentämisen laiminlyönti aiheuttaa nesteen lämpölaajenemista, joka saattaa johtaa laitteen rikkoutumiseen ja henkilövahingon vaaraan.

Eurooppalainen painelaitedirektiivi (PED)

Painelaitteet, joiden paine on suurempi kuin 0,5 bar (g) ja joiden koko on suurempi kuin 25 mm tai 1 tuuma, kuuluvat eurooppalaiseen painelaitedirektiiviin (PED).

- PED direktiiviä koskevat määräykset löytyvät käyttöoppaan "Tekniset tiedot" -luvusta.
- Käyttöoppaassa kuvatut tuotteet ovat 2014/34/EU EU-direktiivin mukaisia.
- Kaikki Brooks Instrumentin virtausmittarit kuuluvat ryhmään 1. Laitteet, jotka ovat suurempia, kuin 25 mm tai 1 tuuma, ovat PED I, II, III kategorioiden mukaisia.
- Mittarit joiden koko on alle 25 mm tai 1 tuuma ovat hyvän konepajakäytännön (SEP) mukaisia.

Eurooppalainen direktiivi sähkömagneettisesta yhteensopivuudesta (EMC)

Brooks Instrumentin CE-merkin saaneet (sähkö/sähköiset) laitteet täyttävät EMC direktiivin vaatimukset ja testit sähkömagneettisesta yhteensopivuudesta (2014/30/EU EMC direktiivi).

Erytystä huomioita on kiinnitettävä CE-merkittyjen laitteiden käytössä olevien kaapelien valintaan.

Kaapelien, kiinnikkeiden ja liittimien laatu:

Brooks Instrumentin kaapelit ovat korkealaatuisia ja täyttävät CE-merkintä direktiivin vaatimukset.

Muun valmistajan kaapelia käytettäessä on käytettävä 100% suojattua kaapelia.

Liittimien tulee olla häiriösuojattua tyyppiä. Tarvittaessa käytetään metallisia kiinnikkeitä kaapelin suojuksen kiinnittämiseen. Kaapelin suojuksen pitää olla yhdistettynä metallisuojukseen tai laippaan ja sen pitää olla molemmista päistä suojattuna 360°. Suojaus päättyy maadoitukseen.

Standardin mukaan korttien liittimet eivät ole metallisia. Käytettyjen kaapelien suojaus on oltava 100%, jotta se täyttäisi CE-merkinnän direktiivin vaatimukset.

Suojaus päättyy maadoitukseen.

Napojen järjestys: Katso liitteenä oleva käyttöopas.

Elektrostaattinen purkaus (ESD)

VAROITUS! Tuote sisältää elektroniikkakomponentteja jotka voivat vahingoittaa staattisesta sähköstä. Sisäisten piirilevyjen purkamisessa, asennuksessa ja käsittelyssä tulee noudattaa kaikkia määräyksiä ja ohjeita.

Asennusohjeet:

1. Järjestelmän sähkötkätkätaan.
2. Laitteen kanssa työskentelevä henkilö on suojattava sähköiskuilta rannehihnalla tai muulla suojaravustuksella ennen piirilevyn tai muun sisäosan asennusta, poistamista tai korjaamista.
3. Piirilevyt kuljetetaan antistaattisessa pakkauksessa. Piirilevyt puretaan paketista juuri ennen asennusta. Poistettu piirilevy on heti pakattava soveltuvaan suojauspakkaukseen kuljettamista, varastointia tai palautusta varten.

Huomautukset:

Tuotteen herkkyys elektrostaattiselle purkaukselle (ESD) ei ole epätavallista. Suurin osa elektroniikkatuotteista sisältää komponentteja jotka hyödyntävät metallioksiditekniikkaa (NMOS, SMOS jne.) Kokemusten mukaan pienikin elektrostaattinen purkaus voi aiheuttaa laitteiden virhetoiminnan tai vahingoittumisen. Vahingoittuneet komponentit saattavat aiheuttaa laitteen ennen aikaisen rikkoutumisen vaikka laite näyttäisi toimivan normaalisti.

French

Instructions essentielles A lire avant de commencer !
<p>Brooks Instrument conçoit, fabrique et teste ses produits pour répondre à de nombreuses normes nationales et internationales. Ces produits doivent être correctement installés, utilisés et entretenus pour pouvoir fonctionner dans le cadre de leurs spécifications normales. Les instructions qui suivent doivent être respectées et intégrées à votre programme de sécurité lors de l'installation, l'utilisation et l'entretien des produits Brooks Instrument.</p> <ul style="list-style-type: none">• Afin d'assurer un fonctionnement correct, faites appel à du personnel qualifié pour l'installation, l'utilisation, la mise à jour, la programmation et l'entretien du produit.• Lisez toutes les instructions avant l'installation, l'utilisation et l'entretien du produit. Si le présent manuel d'utilisation n'est pas le bon, consultez la dernière page de la couverture pour connaître le point de vente le plus proche. Conservez ce manuel d'utilisation pour pouvoir vous y reporter par la suite. <p>▲ AVERTISSEMENT: n'utilisez pas cet instrument au-delà des spécifications énumérées dans le manuel d'utilisation. Le non-respect de cet avertissement peut entraîner de graves blessures et / ou endommager l'équipement.</p> <ul style="list-style-type: none">• Si vous ne comprenez pas l'une des instructions, prenez contact avec un représentant de Brooks Instrument pour obtenir des explications.• Tenez compte de tous les avertissements, précautions et instructions marquées sur le produit et fournies avec celui-ci. <p>▲ AVERTISSEMENT: Avant toute installation, vérifier que cet instrument est conforme aux normes locales et nationales. Le non-respect de cet avertissement peut entraîner des blessures graves et/ou endommager l'équipement.</p> <ul style="list-style-type: none">• Installez votre équipement de la façon indiquée dans les instructions d'installation du manuel d'utilisation et conformément à la législation en vigueur au niveau local et national. Branchez tous les produits aux sources d'électricité et de pression agréées.• Utilisation : (1) Faites lentement entrer le débit dans le système. Ouvrez progressivement les vannes de procédé pour éviter des pics de débits. (2) Vérifiez qu'il n'y a pas de fuite au niveau des branchements d'entrée et de sortie du débitmètre. S'il n'y a pas de fuite, amenez le système à sa pression d'utilisation.• Avant de procéder à l'entretien, assurez-vous que la conduite de procédé n'est plus sous pression. Lorsqu'il faut remplacer une pièce, assurez-vous que les pièces de rechange sont celles indiquées par Brooks Instrument et que des personnes qualifiées effectuent le remplacement. Les pièces et procédures non autorisées peuvent porter atteinte au fonctionnement du produit et mettre en péril la sécurité de votre procédé. Les remplacements par des pièces d'apparence similaire peuvent entraîner des incendies, des risques électriques ou un mauvais fonctionnement.• Vérifiez que toutes les trappes de l'équipement sont fermées et que les couvercles de protection sont en place pour éviter les chocs électriques et les blessures, sauf lorsque l'entretien est réalisé par des personnes qualifiées. <p>▲ AVERTISSEMENT: dans le cas d'appareils à écoulement liquide, si les vannes d'entrée et de sortie adjacentes aux appareils doivent être fermées pour une raison quelconque, les appareils doivent être complètement vidangés. Si cela n'est pas fait, une éventuelle dilatation thermique du fluide peut casser l'appareil et provoquer des blessures.</p>

Directive européenne « équipements sous pression » (PED)
<ul style="list-style-type: none">• Tous les équipements sous pression dont la pression interne est supérieure à 0,5 bar (pression relative) et dont la taille dépasse 25 mm ou un pouce entrent dans le cadre de la directive PED.• La section « Spécifications » de ce manuel contient les instructions relatives à la directive PED.• Les appareils de mesure de ce manuel sont conformes à la directive EN 2014/34/EU.• Tous les débitmètres Brooks Instrument fonctionnent avec des fluides de groupe 1.• Les appareils de mesure d'une taille supérieure à 25 mm ou un pouce entrent dans la catégorie PED I, II ou III.• Les appareils de mesure d'une taille inférieure ou égale à 25 mm ou un pouce relèvent des « bonnes pratiques d'ingénierie » (SEP).

Compatibilité électromagnétique européenne (CEM)
<p>L'équipement Brooks Instrument (électrique / électronique) portant le marquage CE répond à la réglementation en matière de compatibilité électromagnétique (directive CEM 2014/30/EU).</p> <p>Il faut cependant prêter une grande attention au choix du câble d'interconnexion à utiliser avec l'équipement marqué CE.</p> <p>Qualité du câble d'interconnexion, des presse-étoupes et connecteurs :</p> <p>Brooks Instrument fournit un ou des câbles de qualité supérieure qui répondent aux spécifications exigées pour la certification CE. Si vous utilisez votre propre câble d'interconnexion, ce câble doit être protégé par un blindage intégral.</p> <p>Ses connecteurs rectangulaires ou circulaires utilisés doivent avoir un blindage métallique. S'il y a lieu, des presse-étoupes métalliques doivent faire office de serre-écran de câble.</p> <p>L'écran du câble doit être raccordé à l'enveloppe métallique ou au presse-étoupe et blindé aux deux extrémités sur 360 degrés. Le blindage doit s'achever sur une prise de terre.</p> <p>Les connecteurs de carte standards sont non métalliques. Les câbles utilisés doivent être protégés par un blindage intégral pour se conformer à la certification CE.</p> <p>Le blindage doit s'achever sur une prise de terre.</p> <p>En ce qui concerne la configuration des broches, veuillez vous reporter au manuel d'utilisation joint.</p>

ESD (décharge électrostatique)
<p>▲ ATTENTION : cet instrument contient des composants électroniques sensibles à l'électricité statique. Des procédures de manipulation adéquates doivent être respectées pendant le retrait, l'installation ou la manipulation des cartes de circuits imprimés ou des dispositifs internes.</p> <p>Procédure de manipulation :</p> <ol style="list-style-type: none">1. L'alimentation électrique de l'appareil doit être coupée.2. Le personnel doit être mis à la terre, au moyen d'une bande de poignet ou d'un autre moyen sûr et adéquat, avant l'installation, le retrait ou le réglage de toutes les cartes de circuits imprimés ou autres dispositifs internes.3. Les cartes de circuits imprimés doivent être transportées dans un récipient conducteur. Les cartes ne doivent enlevées de cette enveloppe protectrice qu'au dernier moment, juste avant l'installation. Les cartes retirées doivent être immédiatement placées dans un récipient de protection pour le transport, le stockage ou le retour à l'usine. <p>Observations</p> <p>Brooks Instrument n'est pas le seul à proposer des produits comportant des composants sensibles aux décharges électrostatiques. La plupart des produits électroniques modernes contiennent des composants qui utilisent des technologies à oxydes métalliques (NMOS, SMOS, etc.). L'expérience démontre que d'infimes quantités d'électricité statique suffisent à endommager ou détruire ces appareils. Les composants endommagés, même s'ils semblent fonctionner correctement, tombent rapidement en panne.</p>

GF100 Series

German

Wichtige Anweisungen Bitte zuerst lesen!
<p>Brooks Instrument entwickelt, produziert und testet seine Produkte derart, dass sie viele nationale und internationale Standards erfüllen. Nur bei korrektem Einbau sowie richtiger Bedienung und Wartung dieser Produkte ist ein Betrieb unter Einhaltung der Standardvorgaben sichergestellt. Die folgenden Anweisungen müssen eingehalten werden und in Ihr Sicherheitsprogramm integriert werden, wenn Sie Brooks Produkte installieren, bedienen und warten.</p> <ul style="list-style-type: none"> • Um die entsprechende Leistung zu gewährleisten, setzen Sie qualifiziertes Personal für die Installation, den Betrieb, die Aktualisierung, Programmierung und Wartung des Produkts ein. • Lesen Sie alle Anweisungen, bevor Sie das Produkt installieren, in Betrieb nehmen und warten. Falls es sich bei diesem Handbuch nicht um das richtige Handbuch handelt, schauen Sie bitte auf der Rückseite nach den Kontaktdaten Ihres Vertriebsbüros vor Ort. Bewahren Sie dieses Handbuch auf, falls Sie später etwas nachschauen möchten. <p>▲ WARNUNG: Dieses Gerät nicht außerhalb der in Bedienungsanleitung und Handbuch angegebenen Grenzen betreiben. Wird diese Warnung nicht beachtet, kann dies zu schweren Personenschäden bzw. Schäden des Gerätes führen.</p> <ul style="list-style-type: none"> • Falls Sie Anweisungen nicht verstehen, wenden Sie sich zur Klärung an Ihren Brooks Instrument Vertreter. • Befolgen Sie alle Warnhinweise und Anweisungen, die auf dem Produkt markiert sind oder zusammen mit diesem geliefert werden. <p>▲ ACHTUNG: Vor der Installation sicherstellen, dass dieses Instrument den nationalen und lokalen Vorschriften entspricht. Die Nichtbeachtung kann zu schweren Verletzungen und/oder Schäden am Gerät führen.</p> <ul style="list-style-type: none"> • Installieren Sie Ihr Gerät, wie in den Installationsanweisungen des entsprechenden Handbuchs angegeben und gemäß der gültigen regionalen und nationalen Gesetze. Schließen Sie alle Produkte an eine geeignete Strom- und Druckluftversorgung an. • Bedienung: (1) Langsam den Zufluss zum System starten. Die Ventile langsam öffnen, um einen sprunghaften Anstieg der Durchflussmenge zu verhindern. (2) Bereich der Anschlüsse (Zufluss und Ausfluss) des Durchflussmessers auf Undichtigkeiten überprüfen. Wenn das System dicht ist, auf Betriebsdruck hochfahren. • Sicherstellen, dass der Leitungsdruck vor Wartungsarbeiten heruntergefahren wird. Wenn Ersatzteile benötigt werden, stellen Sie sicher, dass qualifizierte Personen Ersatzteile verwenden, die von Brooks Instrument vorgegeben sind. Nicht genehmigte Teile und Verfahren können die Leistungsfähigkeit des Produkts beeinträchtigen und den sicheren Betrieb Ihres Prozesses gefährden. Ähnlich aussehende Austauschteile können zu Bränden, elektrischen Gefahren oder nicht sachgerechtem Betrieb führen. • Stellen Sie sicher, dass alle Türen der Anlage geschlossen sind und dass alle Schutzabdeckungen angebracht sind, um Stromschläge und Personenschäden zu vermeiden, es sei denn die Wartungsaufgaben werden von qualifizierten Personen durchgeführt. <p>▲ WARNUNG: Werden die Ein- und Auslassventile neben Durchflussmessgeräten aus irgendwelchen Gründen geschlossen, so müssen die Geräte komplett entleert werden. Durchflussmessgeräete muessen vor dem Schliessen von Ein- und Auslassventilen komplett entleert werden, anderenfalls kann es zu einer thermischen Ausdehnung der Flüssigkeit und damit zum Bruch des Gerätes kommen; Personenschäden können die Folge sein.</p>

Europäische Druckgeräterichtlinie (PED)
<p>Alle Druckgeräte mit einem internen Druck von mehr als 0,5 bar (g) und einer Größe von mehr als 1in (1 in = 25,4 mm) unterliegen der Druckgeräterichtlinie.</p> <ul style="list-style-type: none"> • Das Kapitel zu den technischen Daten in dieser Anleitung enthält wichtige Sicherheits- und Betriebsanweisungen in Bezug auf die Druckgeräterichtlinie. • Produkte die in diesem Handbuch beschrieben sind, erfüllen die europäische Richtlinie 2014/34/EU. • Alle Durchflussmesser von Brooks Instrument fallen unter die Fluidgruppe 1. • Produkte die größer als 25 mm oder 1" (inch) sind, erfüllen die Kategorien I, II oder III der Druckgeräterichtlinie (PED). • Produkte mit einer Größe von 25 mm oder 1" (inch) oder kleiner sind Sound Engineering Practice (SEP).

Europäische Verordnung zur elektromagnetischen Verträglichkeit (EMV)
<p>Geräte von Brooks Instrument (elektrischer und elektronischer Art) mit CE-Zeichen haben den Test auf Einhaltung der Verordnung zur elektromagnetischen Verträglichkeit (EMV Richtlinie 2014/30/EU) erfolgreich bestanden.</p> <p>Dennoch muss bei der Wahl des Signalkabels für das Gerät mit CE-Zeichen auf folgende Dinge geachtet werden.</p> <p>Qualität von Signalkabel, Kabeldurchführung und Anschlüsse:</p> <p>Brooks Instrument liefert qualitativ hochwertige Kabel, die den Anforderungen für eine CE-Zertifizierung entsprechen. Sollten Sie eigene Kabel einsetzen, so sollte das Kabel überall mit einer 100%-Abschirmung versehen sein.</p> <p>D- oder Rundstecker sollten eine Metallabschirmung aufweisen. Wenn möglich, müssen Kabeldurchführungen aus Metall mit Kabelschirmgeflechts-Klemmen verwendet werden.</p> <p>Der Kabelschirm sollte an die Metallhülle oder -durchführung angeschlossen werden und an beiden Enden rundherum (360°) abgeschirmt werden.</p> <p>Die Abschirmung sollte geerdet werden.</p> <p>Randstecker auf Platinen sind standardmäßig nicht aus Metall. Die verwendeten Kabel müssen mit einer 100 % Abschirmung versehen werden, um die CE-Vorgaben zu erfüllen.</p> <p>Die Abschirmung sollte geerdet werden.</p> <p>Klemmenbelegung: Siehe beigefügtes Handbuch.</p>

ESD (Elektrostatische Entladung)
<p>▲ ACHTUNG: Dieses Gerät enthält elektronische Komponenten, die durch elektrostatische Entladungen beschädigt werden können. Ordnungsgemäße Verfahrensanweisungen müssen während des Ausbaus, der Installation oder anderer Handhabung der eingebauten Platinen oder Geräte eingehalten werden.</p> <p>Verfahrensanweisung:</p> <ol style="list-style-type: none"> 1. Trennen Sie das Gerät von der Stromversorgung. 2. Das Personal ist vor dem Einbau, Ausbau oder der Einstellung von Platinen oder anderen internen Komponenten durch ein entsprechendes Armband mit dem Erdpotential zu verbinden. 3. Platinen sind in speziellen Behältern mit Schutz gegen elektrostatische Spannungen zu transportieren oder zu lagern. Platinen dürfen erst kurz vor dem Einbau aus der Schutzhülle entfernt werden. Ausgebaute Platinen müssen umgehend in Schutzhälter zum Transport, zur Lagerung oder Rücksendung an das Werk gelegt werden. <p>Anmerkung</p> <p>Dieses Gerät ist wie viele andere elektronische Geräte auch mit Komponenten bestückt, die anfällig für elektrostatische Entladung sind. Die meisten modernen, elektronischen Geräte enthalten Komponenten, die die Metalloxidtechnologie (NMOS, SMOS etc.) verwenden. Die Erfahrung hat gezeigt, dass schon geringe Mengen elektrostatischer Energie ausreichen, um diese Geräte zu beschädigen oder zu zerstören. Beschädigte Teile fallen früh aus, obwohl sie funktionsfähig zu sein scheinen.</p>

Greek

**Βασικές οδηγίες
Διαβάστε πριν συνεχίσετε!**

Η Brooks Instrument σχεδιάζει, παράγει και δοκιμάζει τα προϊόντα της σε συμμόρφωση με πλήθος εθνικών και διεθνών προτύπων. Η σωστή εγκατάσταση, χρήση και συντήρησή τους αποτελεί απαραίτητη προϋπόθεση της λειτουργίας εντός των κανονικών ορίων. Οι παρακάτω οδηγίες πρέπει να τηρούνται και πρέπει να ενσωματωθούν στο πρόγραμμα ασφάλειας της εργασίας σας κατά την εγκατάσταση, χρήση και συντήρηση προϊόντων της Brooks Instrument.

- Για σωστό αποτέλεσμα η εγκατάσταση, λειτουργία, ενημέρωση, προγραμματισμός και συντήρηση πρέπει να γίνεται από ειδικευμένο προσωπικό.
- Διαβάστε όλες τις οδηγίες πριν εγκαταστήσετε, λειτουργήσετε και συντηρήσετε το προϊόν. Εάν το παρόν εγχειρίδιο δεν είναι το σωστό εγχειρίδιο, συμβουλευθείτε το πίσω εξώφυλλο για τα στοιχεία επικοινωνίας του τοπικού αντιπροσώπου. Φυλάξτε το εγχειρίδιο αυτό για μελλοντική αναφορά.

▲ ΠΡΟΕΙΔΟΠΟΙΗΣΗ: Μη λειτουργείτε τη συσκευή αυτή καθ' υπέρβαση των ορίων που αναγράφονται στο Εγχειρίδιο Οδηγιών και Λειτουργίας. Η μη συμμόρφωση με την προειδοποίηση αυτή μπορεί να οδηγήσει σε σοβαρό προσωπικό τραυματισμό ή/και ζημιά στον εξοπλισμό.

- Σε περίπτωση μη κατανόησης κάποιας από τις οδηγίες ζητήστε διευκρινίσεις από τον τοπικό αντιπρόσωπο της Brooks Instrument.
- Τηρείτε όλες τις προειδοποιήσεις, προφυλάξεις και οδηγίες που αναγράφονται ή συνοδεύουν το προϊόν.

▲ ΠΡΟΕΙΔΟΠΟΙΗΣΗ: Πριν από την εγκατάσταση βεβαιωθείτε ότι αυτό το εργαλείο διαθέτει τις απαιτούμενες εγκεκριμένες προδιαγραφές ώστε να συμμορφώνεται με τους τοπικούς και εθνικούς κανονισμούς. Η αποτυχία τήρησης της παρούσας προειδοποίησης μπορεί να οδηγήσει σε σοβαρό τραυματισμό και/ή ζημιά στον εξοπλισμό

- Εγκαταστήστε τη συσκευή όπως προβλέπεται στις οδηγίες εγκατάστασης του σωστού εγχειριδίου οδηγιών και στις κείμενες τοπικές και εθνικές διατάξεις. Συνδέστε τα προϊόντα στις εκάστοτε σωστές παροχές ρεύματος και πίεσης.
- Διαδικασία: (1) Αφήστε να ξεκινήσει αργά η ροή στο σύστημα. Ανοίξτε αργά τις βαλβίδες λειτουργίας για να αποφύγετε τις απότομες αυξομειώσεις ροής. (2) Ελέγξτε για διαρροές τις συνδέσεις εισόδου και εξόδου του ροόμετρου. Αν δεν υπάρχουν διαρροές, γεμίστε το σύστημα μέχρι η πίεση να φτάσει την κανονική πίεση εργασίας.
- Πριν από τη συντήρηση βεβαιωθείτε ότι γραμμή εργασίας έχει τεθεί εκτός πίεσεως. Σε περίπτωση αντικατάστασης ανταλλακτικών βεβαιωθείτε ότι το προσωπικό είναι ειδικευμένο και χρησιμοποιεί ανταλλακτικά που προβλέπει η Brooks Instrument. Μη εγκεκριμένα ανταλλακτικά και επεμβάσεις ενδέχεται να επηρεάσουν τις επιδόσεις του προϊόντος και να προκαλέσουν κίνδυνο για την ασφαλή λειτουργία. Αντικαταστάσεις με φαινομενικά όμοια ανταλλακτικά ενδέχεται να προκαλέσουν πυρκαγιά, κίνδυνο ηλεκτροπληξίας ή ανεπαρκή λειτουργία.
- Βεβαιωθείτε ότι όλα τα ανοίγματα του εξοπλισμού είναι κλειστά και τα προστατευτικά καλύμματα είναι στη θέση τους προκειμένου να αποφευχθεί ο κίνδυνος ηλεκτροπληξίας και προσωπικών τραυματισμών, εκτός εάν εκτελούνται εργασίες συντήρησης από ειδικευμένο προσωπικό.

▲ ΠΡΟΕΙΔΟΠΟΙΗΣΗ: Προκειμένου για συσκευές με ροή ρευστού, όταν για οποιονδήποτε λόγο πρόκειται να κλείσουν οι βαλβίδες εισαγωγής και εξαγωγής κοντά στις συσκευές, οι συσκευές πρέπει να αποστραγγιστούν εντελώς. Η μη συμμόρφωση μπορεί να προκαλέσει θερμική διαστολή του υγρού που περιέχουν, με αποτέλεσμα να ραγίσει η συσκευή και να προκληθούν προσωπικοί τραυματισμοί.

Ευρωπαϊκή Οδηγία για τον εξοπλισμό υπό πίεση (PED)

Κάθε εξοπλισμός υπό πίεση με εσωτερική πίεση άνω του 0,5 bar (g) και μεγέθους μεγαλύτερου των 25 mm ή της 1 ίντσας εμπίπτει στις διατάξεις της ευρωπαϊκής Οδηγίας για τον εξοπλισμό υπό πίεση (PED).

- Το κεφάλαιο Προδιαγραφές του παρόντος εγχειριδίου περιλαμβάνει οδηγίες σχετικά με την Οδηγία PED.
- Τα προϊόντα που περιγράφονται στο παρόν εγχειρίδιο συμμορφώνονται με την ευρωπαϊκή Οδηγία 2014/34/EU.
- Όλα τα ροόμετρα της Brooks Instrument ανήκουν στην ομάδα ρευστών 1.
- Προϊόντα μεγαλύτερα από 25 mm ή 1 ίντσα συμμορφώνονται με τις κατηγορίες I, II και III της Οδηγίας PED.
- Προϊόντα μεγέθους 25 mm ή 1 ίντσας ή και μικρότερα κατασκευάζονται σύμφωνα με ορθές τεχνικές πρακτικές (SEP).

Ευρωπαϊκή Οδηγία για την ηλεκτρομαγνητική συμβατότητα (EMC)

Ο (ηλεκτρικός/ηλεκτρονικός) εξοπλισμός της Brooks Instrument που φέρει το σήμα CE έχει υποστεί επιτυχώς τις δοκιμές που προβλέπουν οι διατάξεις της Οδηγίας για την ηλεκτρομαγνητική συμβατότητα (Οδηγία 2014/30/EU για την EMC).

Πάντως χρειάζεται ιδιαίτερη προσοχή στην επιλογή του καλωδίου σήματος για τον εξοπλισμό που φέρει το σήμα CE.

Ποιότητα των καλωδίων σήματος, στυπιοθλιπών και βυσμάτων καλωδίων:

Η Brooks Instrument προσφέρει υψηλής ποιότητας καλώδια τα οποία πληρούν τις προδιαγραφές CE.

Σε περίπτωση παροχής δικού σας καλωδίου σήματος, χρησιμοποιείτε καλώδιο με πλήρη θωράκιση 100% σε όλα τα σημεία.

Βύσματα τύπου «D» ή κυκλικά πρέπει να έχουν μεταλλική θωράκιση. Να χρησιμοποιηθούν κατά προτίμηση μεταλλικοί στυπιοθλιπτες καλωδίων για τη στερέωση της θωράκισης.

Να συνδεθεί η θωράκιση του καλωδίου στο μεταλλικό κέλυφος ή στυπιοθλιπτή και να θωρακιστεί και στα δύο άκρα κατά 360 μοίρες. Η θωράκιση πρέπει να τερματίζει σε γείωση εδάφους.

Τα βύσματα άκρου της πλακέτας είναι εκ κατασκευής μη μεταλλικά. Τα χρησιμοποιούμενα καλώδια πρέπει να έχουν 100% θωράκιση για συμμόρφωση με την πιστοποίηση CE. Η θωράκιση πρέπει να τερματίζει σε γείωση εδάφους.

Για τη διάταξη των ακίδων: Συμβουλευθείτε το συνημμένο εγχειρίδιο οδηγιών.

Ηλεκτροστατική εκκένωση (ESD)

▲ ΠΡΟΦΥΛΑΞΗ: Η συσκευή αυτή περιέχει ηλεκτρονικά εξαρτήματα τα οποία μπορούν να υποστούν εύκολα βλάβες από τον στατικό ηλεκτρισμό. Πρέπει να ακολουθούνται οι ορθές διαδικασίες χειρισμού κατά την αφαίρεση, τοποθέτηση ή άλλο χειρισμό των εσωτερικών πλακετών και διατάξεων.

Διαδικασία χειρισμού:

1. Θέστε τη συσκευή εκτός τάσεως.
2. Φροντίστε για τη γείωση του προσωπικού με περικάρπιο ή άλλο ασφαλές και κατάλληλο μέσο πριν τοποθετήσετε, αφαιρέσετε ή ρυθμίσετε κάρτες τυπωμένων κυκλωμάτων ή άλλη εσωτερική διάταξη.
3. Οι κάρτες τυπωμένων κυκλωμάτων πρέπει να μεταφέρονται σε συσκευασία από αγώγιμο υλικό. Οι κάρτες δεν πρέπει να αφαιρεθούν από το προστατευτικό περιβλήμα παρά μόνο αμέσως πριν από την τοποθέτηση. Οι κάρτες που αφαιρέθηκαν πρέπει να τοποθετηθούν αμέσως σε προστατευτική συσκευασία για μεταφορά, αποθήκευση ή επιστροφή στο εργοστάσιο.

Παρατηρήσεις:

Η ύπαρξη εξαρτημάτων ευαίσθητων στα φαινόμενα ESD (ηλεκτροστατικής εκκένωσης) δεν είναι μοναδικό χαρακτηριστικό της συσκευής αυτής. Οι περισσότερες σύγχρονες ηλεκτρονικές συσκευές περιέχουν εξαρτήματα τεχνολογίας μεταλλικών οξειδίων (NMOS, SMOS κ.ά.). Η πείρα έχει αποδείξει ότι μια μικρή ποσότητα στατικού ηλεκτρισμού αρκεί για να προκαλέσει βλάβες ή να καταστρέψει τις συσκευές αυτές. Εξαρτήματα που υπέστησαν βλάβη, ακόμη και αν μοιάζουν να λειτουργούν σωστά, κινδυνεύουν από πρώιμη αστοχία.

GF100 Series

Hungarian

Alapvető utasítások Először olvassa el ezeket!

A Brooks Instrument olyan módon tervezi, gyártja és teszti termékeit, hogy azok megfeleljenek számos belföldi és nemzetközi szabványnak. Ezeket a berendezéseket megfelelően kell telepíteni, üzemeltetni és karbantartani ahhoz, hogy mindenképpen a normál működési tartományuknak megfelelően üzemelhessenek. Az alábbi utasításokat be kell tartani, és be kell építeni a munkavédelmi programba a Brooks Instrument termékeinek telepítése, üzemeltetése és karbantartása során.

A megfelelő teljesítmény garatalása érdekében kizárólag szakképzett személyzet végezze a termék telepítését, üzemeltetését, frissítését, programozását és karbantartását.

Valamennyi utasítást el kell olvasni a termék telepítése, üzemeltetése és szervizelése előtt. Amennyiben ez a kézikönyv nem a megfelelő kiadvány, a hátsó borítón keresse meg a helyi forgalmazót, és további tájékoztatásért lépjen kapcsolatba vele. Őrizze meg ezt a kézikönyvet későbbi tájékoztatásként.

▲ FIGYELEM: Ne működtesse a berendezést az üzemeltetési utasításban megadott üzemi tartományokon túl. Ennek megsértése súlyos személyi sérüléshez vagy a berendezés meghibásodásához vezethet.

- Amennyiben a kézikönyv utasításai nem egyértelműek, lépjen kapcsolatba Brooks Instrument képviselőjével, hogy tisztázzák a problémát.
- Tartsa be a berendezésen feltüntetett vagy azzal együtt szállított összes figyelmeztetést, felhívást és utasítást.

▲ FIGYELEM: Üzembe helyezés előtt győződjön meg arról, hogy a műszer rendelkezik-e a helyi és nemzeti szabványoknak megfelelő jóváhagyásokkal. Ennek elmulasztása súlyos személyi sérülést és / vagy az eszköz károsodását okozhatja!

- A megfelelő telepítési utasításban megadott utasítások valamint a hatályos helyi és nemzeti előírások szerint telepítse a berendezést. A termékeket kizárólag a megfelelő elektromos és nyomásellátó forrásra kösse.
- Menete: (1) Lassan helyezze nyomás alá a rendszert. Lassanként nyissa ki az üzemi szelepeket az áramlasingadozás elkerülése érdekében. (2) Ellenőrizze, nincs-e szivárgás az áramlásmérő be-, és kimeneti bekötéseinél. Ha nincs szivárgás, töltsen fel a rendszert az üzemi nyomásra.
- Szervizelés előtt mindenképpen ellenőrizze, hogy az üzemi vezeték nincs-e nyomás alatt. Amennyiben cserealkatrészekre van szükség, mindenképpen szakképzett személynek kell kezelnie a Brooks Instrument által meghatározott cserealkatrészeket. A nem engedélyezett alkatrészek és tevékenységek befolyásolhatják a termék teljesítményét, illetve veszélyeztethetik a biztonságos üzemeltetést. A pusztán hasonló alkatrészekkel történő helyettesítés tüzet, áramütésveszélyt vagy elégtelen működést eredményezhet.
- A berendezés összes ajtaja mindenképpen legyen zárva, a védőburkolatok pedig legyenek a helyükön az áramütés és a személyi sérülések elkerülése érdekében, kivéve, ha szakképzett szakember végez rajta karbantartási munkákat.

▲ FIGYELEM: Folyadékot áramoltató berendezések esetében, ha bármilyen okból el kell zárni a berendezés melletti ki-, és belépő szelepeket, a berendezést teljesen le kell üríteni. Ennek elmulasztása a folyadék hőtágulását okozhatja, ami károsíthatja a berendezést, és személyi sérüléshez vezethet.

Nyomástartó berendezésekre vonatkozó európai irányelv (PED)

Minden 0,5 bar-nál (g) magasabb belső nyomású és 25 mm-nél vagy 1 hüvelyknél nagyobb nyomástartó berendezés a nyomástartó berendezésekre vonatkozó európai irányelv (PED) hatálya alá tartozik.

- A használati utasítás „Műszaki adatok” fejezete tartalmaz a PED irányelvre vonatkozó utasításokat.
- A használati utasításban megadott termékek megfelelnek a 2014/34/EU EU irányelvnek.
- Minden Brooks átfolyásmérő az 1-es folyadékcsoporthoz tartozik.
- A 25 mm-nél vagy 1 hüvelyknél nagyobb termékek megfelelnek a PED I, II, vagy III kategóriának.
- A 25 mm-es illetve 1 hüvelykes vagy kisebb termékek az elfogadott mérnöki gyakorlatot (SEP) követik.

Elektromágneses kompatibilitásra vonatkozó európai irányelv (EMC)

A Brooks Instrument CE jelölést kiérdemelt (elektromos/elektronikus) berendezései sikeresen teljesítették az elektromágneses kompatibilitási követelményeket (2014/30/EU sz. EMC irányelv) vizsgáló teszteket.

Ugyanakkor különös figyelmet kell fordítani a CE jelölésű berendezésekhez felhasznált jelképek kiválasztására.

▲ jelképek, kábelösszekötők, csatlakozók minősége:

A Brooks Instrument magas minőségű kábeleket kínál, melyek megfelelnek a CE minősítés követelményeinek.

Amennyiben saját jelkébelt alkalmaznak, olyat kell választani, amely 100%-os árnyékolással, teljes mértékben szűr.

A „D” vagy „kör alakú” csatlakozóknak fémárnyékolóval árnyékoltnak kell lennie. Szükség esetén fém kábelösszekötőket kell alkalmazni a kábelszűrő rögzítésére.

A kábelszűrőt a fém házhoz vagy hüvelyhez kell csatlakoztatni és mindkét felén 360°-ban le kell árnyékolni. Az árnyékolásnak földelésben kell végződnie.

A kártyához tartozó csatlakozók szabványosan nem fémek. Az alkalmazott kábeleknél 100%-os árnyékolással szűrteknek kell lenniük, hogy megfeleljenek a CE minősítésnek.

Az árnyékolásnak földelésben kell végződnie.

Érintkező konfiguráció: Lásd a mellékelt kezelési utasítást.

Elektrosztatikus kisülés (ESD)

▲ VIGYÁZAT: A készülék olyan alkatrészeket tartalmaz, melyek hajlamosak a statikus elektromosság okozta károsodásra. Be kell tartani a megfelelő eljárásokat a belső áramköri kártyák és eszközök eltávolítása, behelyezése vagy egyéb kezelése során.

Kezelési eljárás:

1. A berendezést áramtalanítani kell.
2. A személyt földelni kell csuklópánttal vagy egyéb biztonságos és a célra alkalmas eszközzel, mielőtt áramköri kártyát vagy egyéb belső eszközt telepítene, venne ki, vagy állítana be.
3. A nyomtatott áramköri kártyákat vezetőképes csomagolásban kell szállítani. A kártyák kizárólag közvetlenül a behelyezés előtt vehetők ki a védőburkolatból. A kiserelt kártyát haladéktalanul el kell helyezni a mozgásra, raktározásra vagy a gyári visszaszállításra szolgáló védőcsomagolásba.

Megjegyzések:

Nem egyedi jelenség, hogy a készülékben elektrosztatikus kisülésre (ESD) érzékeny alkatrészek találhatók. A legtöbb korszerű elektronikus eszközben fémoxid technológiás alkatrészek (NMOS, SMOS stb.) találhatók. A tapasztalatok azt igazolják, hogy még kis mértékű statikus elektromosság is károsíthatja, vagy tönkretelheti ezeket az eszközöket. A károsodott alkatrészek, még ha látszólag megfelelően működnek is, kezdődő hibára utalnak.

Italian

**Istruzioni fondamentali
Leggerle subito!**

La Brooks Instrument progetta, fabbrica e collauda i propri prodotti in maniera tale che siano conformi ai vari standard nazionali ed internazionali. Tali apparecchiature devono essere installate, messe in esercizio e tenute in manutenzione in maniera adeguata affinché operino in conformità alle loro normali specifiche di funzionamento. Le seguenti istruzioni devono essere rispettate ed inserite nel programma di tutela sul lavoro durante l'installazione, il funzionamento e la manutenzione dei prodotti Brooks Instrument.

- Per garantire un adeguato rendimento l'installazione, il funzionamento, l'aggiornamento, la programmazione e la manutenzione del prodotto devono essere eseguiti esclusivamente da personale specializzato.
- Leggere tutte le istruzioni prima dell'installazione, utilizzo e manutenzione del prodotto. Se questo manuale non è quello relativo al Vostro prodotto, cercare sul retro della copertina il distributore locale e contattarlo per ulteriori informazioni. Conservare il presente manuale per future consultazioni.

⚠ ATTENZIONE: Non utilizzare questo strumento in condizioni che eccedono le specifiche riportate nel Manuale d'Uso. L'inosservanza può causare gravi lesioni alle persone e/o danni all'apparecchiatura.

- Qualora le istruzioni del manuale non siano chiare, contattare un rappresentante della Brooks Instrument per chiarire il problema.
- Rispettare tutti gli avvisi, le istruzioni e gli avvertimenti riportati sull'apparecchiatura o forniti insieme ad essa.

⚠ ATTENZIONE: prima di installare questo strumento, assicurarsi che sia in regola rispetto alle normative di sicurezza locali e nazionali. La non osservanza di questo avvertimento può procurare seri danni a persone e/o danneggiare sia lo strumento che le cose circostanti.

- Installare l'apparecchiatura in base alle istruzioni riportate nel Manuale d'Uso e alle prescrizioni locali e nazionali in vigore. Collegare i prodotti esclusivamente ad un'adeguata sorgente di pressione ed alimentazione elettrica.
- Procedimento: (1) mettere lentamente sotto pressione il sistema. Aprire lentamente le valvole di servizio per evitare l'oscillazione del flusso. (2) Controllare che non ci siano perdite nei punti di connessione in entrata e in uscita del misuratore di flusso. Se non ci sono perdite, caricare il sistema alla pressione d'esercizio.
- Prima di effettuare manutenzione controllare che la linea di processo non sia sotto pressione. Se avete bisogno di pezzi di ricambio, il personale specializzato deve usare i pezzi di ricambio definiti dalla Brooks Instrument. Attività e pezzi di ricambio non autorizzati possono influire sul rendimento del prodotto e comprometterne il funzionamento in sicurezza. La sostituzione con pezzi di ricambio non originali può causare incendi, pericolo di scosse elettriche o funzionamento improprio.
- Tutti gli sportelli dell'impianto devono essere chiusi, le cappe di protezione devono essere al loro posto per evitare scosse elettriche e lesioni personali, tranne quando il personale specializzato esegue lavori di manutenzione.

⚠ ATTENZIONE: In caso di apparecchiature in cui scorre un liquido, se per qualsiasi motivo bisogna chiudere le valvole d'entrata e d'uscita accanto all'apparecchiatura, allora si deve svuotare completamente l'apparecchiatura. L'inosservanza può causare la dilatazione termica del liquido che può danneggiare l'apparecchiatura e provocare lesioni alle persone.

Direttiva europea relativa alle apparecchiature a pressione (PED)

Ogni apparecchiatura a pressione con pressione interna maggiore di 0,5 bar (g) e più grande di 25 mm o di 1 pollice ricade nell'ambito della Direttiva Europea relativa alle apparecchiature a pressione (PED).

- Il capitolo „Dati tecnici” del manuale contiene le disposizioni relative alla direttiva PED.
- I prodotti di misura descritti nel presente manuale sono conformi alla Direttiva UE 2014/34/EU.
- Ogni flussimetro Brooks appartiene al gruppo di fluidi 1.
- I prodotti di misura maggiori di 25 mm o di 1 pollice sono conformi alla categoria I, II o III della PED.
- I prodotti di misurazione minori di 25 mm o di 1 pollice rientrano nella categoria SEP (Sound Engineering Practice).

Direttiva europea relativa alla compatibilità elettromagnetica (EMC)

Le apparecchiature (elettriche/elettroniche) Brooks Instrument dispongono del marchio CE ed hanno superato positivamente i test per i requisiti di compatibilità elettromagnetica (Direttiva EMC 2014/30/EU).

In ogni caso bisogna prestare particolare attenzione alla scelta dei cavi di segnale utilizzati per le apparecchiature con marchio CE.

Qualità dei cavi di segnale, dei pressacavi e dei connettori:

La Brooks Instrument offre cavi d'alta qualità conformi ai requisiti della certificazione CE.

Qualora vengano utilizzati cavi di segnale propri, devono essere scelti con schermatura al 100% e interamente filtrati.

I connettori „D” o „rotondi” devono essere schermati con schermatura metallica. In caso di necessità bisogna utilizzare pressacavi metallici di collegamento per fissare la schermatura del cavo.

La schermatura del cavo deve far contatto col guscio metallico o col pressacavo; il cavo deve essere schermato su entrambi i lati a 360°. La schermatura deve essere effettuata con messa a terra.

I connettori Card Edge normalmente non sono di metallo. I cavi utilizzati devono essere filtrati con schermatura al 100% per essere conformi alla marcatura CE.

La schermatura deve essere effettuata con messa a terra.

Configurazione pin: Vedi Manuale d'uso allegato.

Scarica elettrostatica (ESD)

⚠ ATTENZIONE: Il dispositivo contiene componenti elettronici che possono essere danneggiati da elettricità statica. Bisogna rispettare le adeguate procedure durante la rimozione, l'installazione o altra manovra delle schede del circuito elettrico interno.

Procedura di manovra:

1. Togliere alimentazione elettrica all'apparecchiatura.
2. La persona deve essere collegata a terra con una cerniera o con altri strumenti di sicurezza e adeguati allo scopo prima di installare, togliere o impostare la scheda del circuito elettrico o altri dispositivi interni.
3. Le schede del circuito stampato devono essere spedite in contenitori conduttivi. Le schede devono essere tolte dal rivestimento protettivo esclusivamente prima dell'installazione. Le schede confezionate devono essere collocate immediatamente nell'imballaggio protettivo per la movimentazione, l'immagazzinamento o resa alla fabbrica.

Note:

È un fenomeno comune che nei dispositivi di questo tipo si trovino componenti sensibili alla scarica elettrostatica (ESD). Nella maggior parte degli strumenti elettronici moderni si trovano componenti tecnologici metallo-ossido (NMOS, SMOS, ecc.). Le esperienze dimostrano che l'elettrostaticità anche in piccola misura può danneggiare o rovinare gli strumenti. I componenti danneggiati, anche se all'apparenza funzionano correttamente, potrebbero manifestare il difetto rapidamente.

GF100 Series

Latvian

Svarīga instrukcija

Pirms turpināt izlasiet!

„Brooks Instrument” projektē, ražo un pārbauda savus izstrādājumus atbilstoši daudziem nacionālajiem un starptautiskajiem standartiem. Lai nodrošinātu šo izstrādājumu turpmāku darbību atbilstoši noteiktajiem parametriem, tie ir pareizi jāuzstāda, jālieto un jāapkopi. Uzstādot, lietojot „Brooks Instrument” izstrādājumus un veicot to apkopi, ir jāievēro šie norādījumi un jāiekļauj tie jūsu drošības programmā.

- Lai nodrošinātu pienācīgu izstrādājuma sniegumu, izstrādājuma uzstādīšanu, lietošanu, atjaunināšanu, programmēšanu un apkopi uzticiet veikt tikai kvalificētam personālam.
- Pirms izstrādājuma uzstādīšanas, lietošanas un apkalpošanas izlasiet visus norādījumus. Ja šī instrukciju rokasgrāmata nav pareizā, izstrādājumam atbilstošā rokasgrāmata, lūdzu skat. aizmugurējo vāku, kur ir sniegta vietējā tirdzniecības biroja kontaktinformācija.
 - ▲ **BRĪDINĀJUMS! Nelietot instrumentu ārpus Instrukciju un lietošanas rokasgrāmatā norādītajiem parametriem. Šī brīdinājuma neievērošanas rezultātā var rasties traumas un/vai aprikojuma bojājumi.**
- Ja jūs nesaprotat kādu no instrukcijām, sazinieties ar „Brooks Instrument” pārstāvi un lūdziet izskaidrot to.
- Ievērojiet visus brīdinājumus, piesardzības mērus un instrukcijas, kas norādīti uz izstrādājuma vai piegādāti kopā ar to.
 - ▲ **BRĪDINĀJUMS. Pirms uzstādīšanas pārliecinieties, ka šim instrumentam ir nepieciešamie apstiprinājuma novērtējumi, lai atbilstu vietējiem un valsts kodeksiem. Šī brīdinājuma neizlasīšanas rezultātā var rasties nopietni personas savainojumi un/vai aprikojuma bojājumi.**
- Uzstādiet aprikojumu tā, kā tas norādīts attiecīgajā instrukciju rokasgrāmatā iekļautajā uzstādīšanas instrukcijā un atbilstoši piemērojumam atbilstošām un nacionālajām normām. Pievienojiet visus izstrādājumus pareizi elektriskajiem un spiediena avotiem.
- Lietošana: (1) Lēnām uzsāciet plūsmu sistēmā. Lai izvairītos no straujiem plūsmas kāpumiem, lēnām atveriet procesa vārstus. (2) Pārbaudiet, vai nav noplūdes ap plūsmas mērītāja ietilpdes un izplūdes savienojumiem. Ja noplūdes nav, uzstādiet sistēmā darba spiedienu.
- Pārliecinieties par to, lai pirms instrumenta tehniskās apkopes būtu likvidēts procesa līnijas spiediens. Ja ir nepieciešams veikt kādu daļu nomaiņu, nodrošiniet, lai tiktu izmantotas „Brooks Instrument” norādītās daļas un daļu nomaiņu veiktu kvalificēts personāls. Neatļautu daļu un procedūru izmantošana var ietekmēt izstrādājuma sniegumu un samazināt procesa drošību. Līdzīgu, bet ne identisku daļu nomaiņas lietošana var izraisīt ugunsgrēka, elektrisko traucējumu riskus un nepareizu izstrādājuma darbību.
- Nodrošiniet, lai būtu aizvērtas visas durvis un būtu pareizi uzstādīti visi aizsargpārsegumi, tādējādi novēršot elektrošoka un trauma risku. Izņēmums ir gadījumi, kad kvalificēts personāls veic ražojuma apkopi.
 - ▲ **BRĪDINĀJUMS! Ja šķidrās plūsmas ierīču tuvumā esošos ietilpdes un izplūdes vārstus kāda iemesla dēļ ir jāaizver, no ierīcēm ir jāizlaiž viss šķidrums. Pretējā gadījumā šķidrums var termiski izplesties, pārraut ierīci un radīt traumas.**

Eiropas spiedieniekārtu direktīva (PED)

Uz visām spiedieniekārtām, kuru iekšējais spriegums pārsniedz 0,5 bar (g) un ir lielākas par 25 mm jeb 1" (collu), attiecas Eiropas spiedieniekārtu direktīva (PED).

- Šīs rokasgrāmatas tehnisko parametru nodalījā ir sniegtas a PED Direktīvu saistītās instrukcijas.
- Šajā rokasgrāmatā aprakstītie izstrādājumi atbilst EN Direktīvas 2014/34/EU prasībām.
- Visi „Brooks Instrument” plūsmas mērītāji ietilpst 1. šķidrumu grupā.
- Uz 25 mm jeb 1" (collu) maziem un mazākiem izstrādājumiem attiecas labas inženierijas prakse (SEP).
- 25 mm jeb 1" (collu) mazi vai mazāki izstrādājumi atbilst PED kategorijai I, II vai III.

Eiropas elektromagnētiskās savietojamības direktīva (EMS)

„Brooks Instrument” (elektriskās/elektroniskās) iekārtas ar CE zīmi ir izturējušas pārbaudi un atzītas par atbilstošām Eiropas elektromagnētiskās savietojamības direktīvas (EMS) prasībām (EMS 2014/30/EU)

Tomēr, izvēloties signālkabeļi, kas tiks lietoti kopā ar CE marķējuma iekārtu, ir jāievēro īpaša uzmanība.

Signālkabeļa, kabeļa blīvslēgu un savienotāju kvalitāte:

„Brooks Instrument” piegādā augstas kvalitātes kabeļus, kas atbilst CE sertifikācijas tehniskajiem parametriem.

Ja jūs lietojat pats savu signālkabeļi, tam ir jābūt pilnībā, 100% ekranizētam.

„D” un „apaļā” tipa savienotājiem ir jābūt aprīkoti ar metāla ekranizējumu. Ja nepieciešams, ir jāizmanto metāla blīvslēgi ar kabeļa ekranizējuma skavojumā.

Kabeļa ekranizējumam ir jābūt savienotam ar metāla apvalku un abās pusēs aizsargātam 360 grādu diapazonā.

Ekranizējumam ir jābeidzas pie iezemējuma.

„Card Edge” savienotāji standarta izpildījumā ir nemetāla. Kabeļiem ir jābūt pārklātiem ar 100% ekranizējumu, lai tie atbilstu CE sertifikācijas prasībām.

Ekranizējumam ir jābeidzas pie iezemējuma.

Attiecībā uz tapu konfigurāciju: skat. pievienoto instrukciju rokasgrāmatu.

ESD (elektrostatiskā izlāde)

▲ **IEVĒROT PIESARDZĪBU! Šis instruments satur elektriskos komponentus, kas ir jutīgi pret statisko elektrību. Izņemot un uzstādot iekšējās ķēdes plates un ierīces vai kā citādi darbojoties ar tām, ir jāievēro noteikta darba kārtība.**

Darba kārtība:

- Iekārta jāatslēdz no barošanas.
- Pirms jebkādas drukātas shēmas kartes vai citas iekšējās ierīces uzstādīšanas, izņemšanas vai regulēšanas personālam, kas veiks šos darbus, ir jābūt iezemētam, piem., izmantojot procesa vai citus drošus, piemērotus līdzekļus.
- Drukātās shēmas kartes ir jātransportē vadošā iepakojumā. Plāksnes no aizsargkorpusa drīkst izņemt tikai tieši pirms uzstādīšanas. Transportējot, uzglabājot vai atgriežot rūpnīcā, izņemtas plāksnes ir nekavējoties jāievieto aizsargiepakojumā.

Komentāri

Instruments nav unikāls tajā aspektā, ka tas satur pret ESD (elektrostatisko izlādi) jutīgus komponentus. Vairākums mūsdienu elektroiekārtu satur komponentus, kuru ražošanā izmantota metāla oksīdu tehnoloģijas (NMOS, SMOS u.c.). Pieredze rāda, ka pat neliels daudzums statiskās elektrības var nodarīt bojājumus šādām ierīcēm vai pilnībā sabojāt tās. Bojātie komponenti pat tad, ja tie šķietami darbojas pareizi, ir pakļauti ātrākam atteicei.

Lithuanian

Pagrindinės instrukcijos

Perskaitykite prieš tęsdami!

„Brooks Instrument“ projektuoja, gamina ir išbanda savo gaminius, kad jie atitiktų įvairius nacionalinius ir tarptautinius standartus. Šie gaminiai turi būti tinkamai montuojami, eksploatuojami ir prižiūrimi, kad ir toliau veiktų pagal jiems būdingus techninius parametrus. Toliau pateiktų nurodymų reikia laikytis ir įtraukti juos į saugos programą montuojant, eksploatuojant ir prižiūrint „Brooks Instrument“ gaminius.

- Siekiant užtikrinti tinkamą veikimą, montuoti, eksploatuoti, naujinti, programuoti ir prižiūrėti gaminį turi tik kvalifikuoti darbuotojai.
- Perskaitykite visus nurodymus prieš montuodami, eksploatuodami ir prižiūredami gaminį. Jei gavote netinkamą instrukciją, galiniame jos viršelyje ieškokite vietinės prekybos atstovybės kontaktinės informacijos. Neišmeskite šios instrukcijos, jos gali prireikti ateityje.

⚠️ ĮSPĖJIMAS: nenaudokite šio prietaiso viršydami instrukcijoje ir eksploatacijos vadove nurodytus techninius duomenis. Nesilaikydami šio įspėjimo galite sunkiai susižeisti ir (arba) sugadinti įrangą.

- Jei nesuprantate kokių nors nurodymų, kreipkitės į „Brooks Instrument“ atstovą, kad paaiškintų.
- Paisykite visų įspėjimų, perspėjimų ir nurodymų, pažymėtų ant gaminio arba pateiktų su juo.

⚠️ ĮSPĖJIMAS: prieš montuodami įsitinkinkite, kad ši įrangą atitinka vietinius ir nacionalinius teisės aktus. Nepaisant šio įspėjimo gali būti sužeisti žmonės ir (arba) pažeista įrangą.

- Įrangą montuokite taip, kaip nurodyta atitinkamos instrukcijos montavimo nurodymuose arba taikomuose vietiniuose ar nacionaliniuose teisės aktuose. Visus gaminius junkite prie tinkamų elektros ir slėgio šaltinių.
- Naudojimas: (1) lėtai įjunkite srautą į sistemą. Lėtai atidarykite proceso vožtuvus, kad išvengtumėte srauto antplūdžių. (2) Patikrinkite, ar nėra nuotėkių aplink srauto matuoklio įleidimo ir išleidimo jungtis. Jei nuotėkių nėra, sukurkite sistemoje darbinį slėgį.
- Prieš atlikdami priežiūros darbus būtina pašalinti slėgį proceso linijoje. Jei reikia pakeisti dalis, užtikrinkite, kad kvalifikuoti darbuotojai naudotų „Brooks Instrument“ nurodytas pakaitines dalis. Naudojant netinkamas dalis ir netinkamai atliekant procedūras, gali pablogėti gaminio veikimas ir gali kilti pavojus naudojimo proceso saugai. Naudojant tik panašiai atrodančius pakaitalus gali kilti gaisro ar elektros smūgio pavojus arba gaminys gali veikti netinkamai.
- Užtikrinkite, kad visos įrangos durtelės būtų uždarytos, o apsauginiai dangčiai uždėti, kad išvengtumėte elektros smūgio ir sužeidimų, išskyrus, kai kvalifikuoti darbuotojai atlieka priežiūros darbus.

⚠️ ĮSPĖJIMAS: naudojant skysto srauto įrenginius, jei dėl kokios nors priežasties prireikia uždaryti šalia įrenginio esančius įleidimo ir išleidimo vožtuvus, iš įrenginio reikia išleisti visą skystį. To nepadarius galimas šiluminis skysčio plėtimasis, galintis sugadinti įrenginį ir sužeisti žmones.

Europos slėginės įrangos direktyva (PED)

Visa slėginė įrangą, kurios vidinis slėgis didesnis nei 0,5 bar (g), o dydis didesnis nei 25 mm arba 1 col., yra reglamentuojama Slėginės įrangos direktyvos (PED).

- Šios instrukcijos dalyje „Techniniai duomenys“ pateikiami nurodymai, susiję su PED direktyva.
- Šioje instrukcijoje aprašyti gaminiai atitinka Europos Sąjungos direktyvą 2014/34/EU.
- Visi „Brooks Instrument“ srauto matuokliai priklauso 1 skysčių grupei.
- Didesni nei 25 mm arba 1 col. gaminiai atitinka PED I, II arba III kategoriją.
- 25 mm arba 1 col. ar mažesni gaminiai atitinka tinkamą inžinerijos praktiką (SEP).

Europoje taikomi elektromagnetinio suderinamumo (EMS) reikalavimai

CE ženklą pažymėta „Brooks Instrument“ (elektrinė / elektroninė) įrangą buvo sėkmingai išbandyta pagal elektromagnetinio suderinamumo reikalavimus (EMS direktyvą 2014/30/EU).

Tačiau ypač atidžiai reikia rinktis signalizavimo kabelį, kuris bus naudojamas su CE ženklą pažymėta įrangą.

Signalizavimo kabelio, kabelių riebokšlių ir jungčių kokybė:

„Brooks Instrument“ tiekia kokybiškus kabelius, kurie atitinka CE sertifikavimo specifikacijas.

Jei naudojate savo signalizavimo kabelį, jis turi būti visiškai ir visas ekranuotas 100 % ekranu.

Naudojamos „D“ arba „apskrito“ tipo jungtys turi būti ekranuotos metaliniu ekranu. Jei taikoma, reikia naudoti metalinius kabelių riebokšlius, užtikrinančius kabelio ekrano suspaudimą.

Kabelio ekraną reikia jungti prie metalinio apvalkalo ar riebokšlio ir ekranuoti abiejuose galuose 360 laipsnių.

Ekranas turi užsibaigti žeminiu.

Standartinės kraštinės jungtys yra nemetalinės. Naudojami kabeliai turi būti ekranuoti 100 % ekranu, kad atitiktų CE sertifikavimą.

Ekranas turi užsibaigti žeminiu.

Keturių kontaktų konfigūracija: žr. pridėtą instrukciją.

ESD (elektrostatinis išlydis)

⚠️ PERSPĖJIMAS: šie prietaisai yra elektroninių komponentų, kuriuos gali sugadinti statinė elektra. Išimant ar įdedant vidines spausdintines plokštes ar įrenginius, arba atliekant su jomis kitus darbus, reikia laikytis tinkamų darbo procedūrų.

Darbo procedūra:

1. Atjunkite įrenginio maitinimą.
2. Darbuotojai turi pasirūpinti žeminiu naudodami riešo juostelę ar kitas saugias tinkamas priemones prieš įdėdami, išimdami ar reguliuodami bet kokią spausdintinės plokštės kortelę ar kitą vidinį komponentą.
3. Spausdintinės plokštės kortelės reikia transportuoti laidžiamame konteineryje. Neleidžiama išimti plokštės iš apsauginio dėklo, nebent prieš pat įdėjimą. Išimtas plokštės reikia nedelsiant įdėti į apsauginį konteinerį, kuriame jos bus transportuojamos ar saugomos, arba grąžinti į gamyklą.

Pastabos

Šis instrumentas nėra unikalus dėl jame esančių ESD (elektrostatinio išlydžio) jautrių komponentų. Daugelyje šiuolaikinių elektroninių gaminių yra komponentų, kuriuose naudojama metalo oksidų technologija (NMOS, SMOS ir pan.). Patirtis rodo, kad net ir mažas statinės elektros kiekis gali pakenkti tokiems gaminiams ar juos sugadinti. Sugadinti komponentai, net jei atrodo, kad jie veikia tinkamai, greitai sugenda.

GF100 Series

Polish

Niezbędne zalecenia**Prosimy przeczytać przed rozpoczęciem użytkowania!**

Brooks Instrument projektuje, wytwarza i testuje swoje produkty tak, aby spełniały wymagania licznych norm krajowych i międzynarodowych. Produkty te muszą być poprawnie instalowane, obsługiwane oraz konserwowane, aby zapewnić ich prawidłowe działanie zgodnie ze specyfikacją techniczną. Podczas instalowania, obsługiwania i konserwowania produktów firmy Brooks Instrument należy przestrzegać następujących zaleceń:

- Aby zapewnić właściwe działanie sprzętu, instalacja, obsługa, aktualizacje, programowanie i konserwacja powinny być wykonywane przez przeszkolony personel.
- Przed instalacją, obsługą i czynnościami serwisowymi należy zapoznać się ze wszystkimi zaleceniami producenta. Aby uzyskać instrukcję obsługi odpowiednią dla danego sprzętu, należy skontaktować się z lokalnym przedstawicielem handlowym producenta. Instrukcję obsługi należy zachować do późniejszego użycia.

▲ OSTRZEŻENIE: Nie wolno przekraczać podanych w instrukcji zakresów działania urządzenia. Nieprzestrzeganie tego zalecenia może doprowadzić do poważnego zagrożenia życia lub zdrowia personelu i / lub uszkodzenia sprzętu.

- Jeżeli jakieś zalecenia w instrukcji obsługi urządzenia są niezrozumiałe, prosimy o skontaktowanie się z przedstawicielem firmy Brooks Instrument, aby wyjaśnić problem.
- Należy przestrzegać wszystkich ostrzeżeń, uwag i zaleceń umieszczonych na produkcie lub do niego dołączonych

▲ OSTRZEŻENIE: Przed rozpoczęciem instalacji należy sprawdzić, czy wymagana specyfikacja niniejszego urządzenia zgodna jest z miejscowymi i krajowymi normami. Zignorowanie tego ostrzeżenia może spowodować poważne obrażenia ciała i/lub uszkodzenie sprzętu.

- Instalację urządzenia należy przeprowadzić zgodnie z zaleceniami zawartymi w instrukcji instalacji oraz z obowiązującymi lokalnymi i narodowymi oznaczeniami. Wszystkie urządzenia można podłączyć wyłącznie do odpowiednich źródeł energii elektrycznej oraz ciśnienia.
- Pierwsze czynności obsługowe: (1) Należy powoli włączyć przepływ w instalacji. Następnie powoli otworzyć zawory robocze tak, aby uniknąć wahań przepływu. (2) Należy zawsze stosować części zamiennie specyfikowane przez firmę Brooks Instrument a czynności ich wymiany powinny w każdym przypadku dokonywać przeszkolony personel. Stosowanie nieautoryzowanych części i procedur serwisowych może niekorzystnie wpłynąć na działanie produktu oraz zagrozić bezpieczeństwu instalacji. Korzystanie z podobnie wyglądających zamienników może doprowadzić do pożaru, porażenia prądem lub nieprawidłowego działania urządzenia.
- Należy upewnić się, że wszystkie otwory urządzenia są zamknięte a osłony umocowane na swoich miejscach, aby zapobiec obrażeniu ciała lub porażeniu prądem personelu. Zalecenie to nie dotyczy przeszkolonego pracownika wykonującego prace serwisowe lub konserwacyjne.

▲ OSTRZEŻENIE: W przypadku mierników przepływu cieczy, jeżeli znajdujące się na nich zawory wejściowe i wyjściowe mają być z jakiegos powodu zamknięte, to urządzenie musi zostać całkowicie opróżnione z ciekłego medium. Niedopełnienie tego zalecenia może doprowadzić do termicznego zwiększenia objętości cieczy, co z kolei może spowodować uszkodzenie urządzenia i obrażenia personelu.

Europejska dyrektywa dotycząca urządzeń ciśnieniowych (PED)

Wszystkie urządzenia ciśnieniowe pracujące przy ciśnieniu wewnętrznym względnie większym niż 0,5 bara i wielkości powyżej 25 mm lub 1 cala podlegają dyrektywie europejskiej dotyczącej urządzeń ciśnieniowych (PED).

- Rozdział „Specyfikacja techniczna” niniejszej instrukcji zawiera zalecenia dotyczące dyrektywy PED.
- Produkty opisane w tej instrukcji są zgodne z dyrektywą EN 2014/34/EU.
- Wszystkie mierniki przepływu firmy Brooks Instrument należą do 1. grupy cieczy.
- Produkty o wielkości powyżej 25 mm lub 1 cala należą do kategorii I, II lub III dyrektywy PED.
- Produkty o wielkości 25 mm lub 1 cala lub mniejsze podlegają zaleceniom „Uznanej Praktyki Inżynierskiej” (SEP).

Europejska dyrektywa dotycząca kompatybilności elektromagnetycznej (EMC)

Urządzenia elektryczne / elektroniczne firmy Brooks Instrument posiadające oznaczenie CE, przeszły pozytywnie testy pod kątem spełniania przez nich wymogów kompatybilności elektromagnetycznej (Dyrektywa EMC 2014/30/EU).

Jednakże szczególnie uwagę należy poświęcić przy doborze przewodów sygnałowych, które mają być stosowane z urządzeniami ze znakiem CE.

Jakość przewodu sygnałowego, dławic oraz złączy przewodu:

Firma Brooks Instrument dostarcza wysokiej jakości przewody, które spełniają wymagania zawarte w specyfikacji dla certyfikatu CE.

Jeżeli stosuje się własne przewody sygnałowe, to powinny one być w całości w pełni ekranowane.

Złącza typu „D” lub okrągłe powinny zawierać metalowy ekran. Jeśli to możliwe, należy stosować metalowe dławice przewodu zapewniające mocowanie jego ekranu.

Ekran przewodu powinien być połączony z metalową osłoną lub dławicą zapewniając całkowite, dookólne ekranowanie na obu końcach przewodu. Ekran przewodu powinien być uziemiony.

Złącza krawędziowe są standardowo niemetaliczne. Stosowane przewody muszą być w pełni ekranowane zgodnie z certyfikatem CE.

Ekran przewodu powinien być uziemiony.

Konfiguracja styków jest podana w niniejszej instrukcji obsługi.

Wyładowania elektrostatyczne (ESD)

▲ UWAGA: Urządzenie zawiera części elektroniczne podatne na uszkodzenia spowodowane ładunkami elektrostatycznymi. Przy obchodzeniu się z wewnętrznymi podzespołami i częściami elektronicznymi należy przestrzegać następujących zasad postępowania:

1. Należy odłączyć zasilanie od urządzenia.
2. Osoba wykonująca czynności musi zostać uziemiona za pomocą opaski na przegubie dłoni lub w inny, bezpieczny sposób, zanim przystąpi do instalacji, wyjęcia lub regulacji obwodów drukowanych lub innych wewnętrznych podzespołów elektronicznych urządzenia.
3. Obwody drukowane należy transportować w przewodzącym pojemniku. Płytki drukowane należy wyjmować z opakowania ochronnego bezpośrednio przed ich montażem. Wymontowane płytki należy niezwłocznie umieścić w opakowaniu ochronnym służącym do transportowania, składowania lub odsyłania do producenta.

Uwagi:

Fakt, że urządzenie zawiera części nieodporne na wyładowania elektrostatyczne (ESD) jest rzeczą normalną. Większość nowoczesnych urządzeń elektronicznych zawiera komponenty wykonane w technologii tlenków metali (NMOS, SMOS itp.). Jak pokazuje praktyka, nawet niewielkie wyładowanie elektrostatyczne może uszkodzić lub zniszczyć takie urządzenie. Uszkodzone części, nawet jeżeli na pozór działają poprawnie, szybko doprowadzają do nieprawidłowej pracy urządzenia.

Portuguese

Instruções Básicas
Ler antes de proceder!

A Brooks Instrument projecta, fabrica e testa os seus produtos de forma a satisfazer numerosas normas nacionais e internacionais. Estes equipamentos devem ser instalados, utilizados e mantidos de forma adequada, e devem funcionar dentro da sua gama de utilização. As instruções seguintes devem ser, durante a instalação, uso e/ou manutenção dos equipamentos da Brooks Instrument, apreendidas e integradas no plano de protecção e segurança no trabalho.

- Para assegurar o desempenho adequado, a instalação, exploração, actualização e/ou manutenção do equipamento deve ser realizada, exclusivamente, por pessoal qualificado.
- Antes de instalar, utilizar e/ou executar operações de manutenção devem ser lidas todas as instruções do equipamento. No caso do presente manual não ser apropriado procure, na capa traseira, o distribuidor mais próximo e contacte-o para obter informações adicionais. Guarde este manual para futura referência.

⚠ ATENÇÃO: não sujeite o equipamento a condições fora das gamas de serviços indicadas. Ao não respeitar esta advertência poderá provocar avarias no equipamento e/ou danos pessoais.

- Se as instruções deste manual não estiverem suficientemente claras, contacte o representante Brooks Instrument para esclarecer as suas dúvidas.
- Tenha sempre presente todas as advertências, apelos e instruções indicadas no equipamento e/ou fornecidas junto com o mesmo.

⚠ AVISO: Antes de proceder à instalação, certifique-se de que este instrumento está em conformidade com as categorias de homologação exigidas pelas regulamentações locais e nacionais. O incumprimento pode resultar em lesões pessoais graves e/ou danos no equipamento.

- A instalação do equipamento deverá ser efectuada cumprindo todas as instruções indicadas no manual assim como as normas e regulamentos locais e nacionais vigentes. Ligue o equipamento exclusivamente a fontes de energia eléctrica e/ou pneumática adequadas.
- Procedimento: (1) Pressurize lentamente o sistema. Abra lentamente as válvulas para evitar variações bruscas de caudal. (2) Verifique se há fugas nas ligações de entrada e saída do medidor de caudal. Se não detectar fugas, poderá colocar o sistema à pressão de trabalho.
- Antes de efectuar qualquer operação de manutenção verifique sempre a possibilidade do equipamento estar sob pressão. No caso de ser preciso substituir peças, estas devem ser as recomendadas pela Brooks Instrument e o trabalho de substituição deverá ser efectuado por técnicos qualificados. Procedimentos e peças não conformes poderão alterar o desempenho do equipamento, danificá-lo ou colocar em risco a sua segurança ou de outros. Substituir peças por outras não originais, meramente semelhantes, poderá originar choques eléctricos, fogo ou em funcionamento inadequado.
- Deverá manter o equipamento intacto e fechado, verificando se as coberturas de protecção estão nos seus lugares devidos, de forma a evitar choques eléctricos e/ou danos pessoais, excepto no caso de se tratar de um técnico qualificado e se estiver a executar trabalhos de manutenção.

⚠ ATENÇÃO: Se por qualquer razão for necessário fechar as válvulas a montante e jusante do equipamento, tenha em atenção que o mesmo deverá ser previamente esvaziado do fluido que o atravessa. Esta obrigação surge do facto de existir a possibilidade de ocorrer dilatação térmica do líquido, no interior do aparelho, podendo provocar danos pessoais ou materiais graves.

Directiva Europeia para equipamentos sob pressão (PED)

Todos os equipamentos sujeitos a pressão interior superior a 0,5 bar (g) e com calibre superior a 25 mm (1 polegada) estão sob a vigência da directiva europeia de equipamentos sob pressão (PED).

- O capítulo "Dados técnicos" do manual contém instruções relativas à Directiva PED.
- O produto objecto deste manual satisfaz a directiva 2014/34/EU da UE.
- Os caudalímetros Brooks pertencem ao grupo 1 de fluidos.
- Os produtos com calibre superior a 25 mm (1 polegada) pertencem às categorias PED I, II, ou III.
- Os produtos de 25 mm (1 polegada) ou menores seguem as "Boas regras de engenharia" (SEP).

Directiva Europeia sobre Compatibilidade electromagnética (EMC)

Os equipamentos (eléctricos/electrónicos) da Brooks Instrument que têm a marcação CE passaram os testes comprovativos dos requisitos de compatibilidade electromagnética (Directiva EMC número 2014/30/EU).

Todavia, ao utilizar os aparelhos compete-lhe a escolha dos cabos de sinal adequados para os equipamentos com marcação CE.

Qualidade dos cabos de sinal, buçins e conectores:

A Brooks Instrument fornece cabos de alta qualidade que cumprem todos os requisitos da marcação CE.

No caso de utilizar os seus próprios cabos de sinal, assegure uma blindagem a 100%.

Os conectores do tipo "D" ou "circular" têm que ser blindados por uma malha metálica. Se precisar de usar buçins, estes têm que permitir a crimpagem da malha/blindagem do cabo.

A blindagem do cabo deve ser ligada ao corpo metálico ou bocal e assegurando a blindagem em 360°. A blindagem deve terminar numa ligação à terra.

Os conectores ligados a cartões serão, em geral, não-metálicos. Os cabos utilizados devem ter fita de blindagem a 100% para satisfazer a marcação CE.

A blindagem, deverá terminar numa ligação à terra.

Atribuição de pinos: Veja as instruções de operação anexas.

Descarga Electrostática (ESD)

⚠ ATENÇÃO: Alguns componentes deste equipamento são susceptíveis à acção da electricidade estática, podendo ficar danificados. Ao remover, colocar ou manipular placas de circuitos electrónicos deverá ter em atenção os seguintes procedimentos:

1. Desligar o equipamento da rede.
2. O utilizador, antes de qualquer intervenção que envolva os cartões de circuitos ou outros dispositivos internos, terá que se ligar à terra por meio duma bracelete de pulso ou outro dispositivo adequado.
3. Os circuitos impressos deverão ser transportados numa embalagem condutiva. Os cartões só deverão ser retirados da embalagem protectora imediatamente antes da sua inserção. O cartão retirado deverá ser recolocado imediatamente na embalagem protectora que servirá para o seu transporte, armazenagem ou retorno a fábrica.

Observações:

Tenha presente que este equipamento poderá não ser o único objecto capaz de ser portador de peças sensíveis a descargas electrostáticas (ESD).

Na maioria dos dispositivos electrónicos Brooks encontram-se peças de tecnologia de óxidos metálicos (NMOS, SMOS, etc.). A experiência mostra que até pequenas quantidades de electricidade estática são capazes de danificar ou destruir esses dispositivos. Os componentes danificados, embora inicialmente funcionem aparentemente bem, acabam por ter falhas prematuramente.

GF100 Series

Romanian

Indicații de referință**Citiți-le întâi pe acestea!**

Brooks Instrument își proiectează, produce și testează produsele într-un mod ce respectă un mare număr de standarde autohtone și internaționale. Aceste instalații trebuie amplasate, exploatate și întreținute corespunzător, pentru ca în toate situațiile, domeniul lor de lucru să corespundă operării normale. În ceea ce privește instalarea, operarea și întreținerea produselor Brooks Instrument, indicațiile de mai jos trebuie respectate și trebuie introduse în programul de protecția muncii.

- Pentru garantarea prestației corecte, instalarea, operarea, actualizarea, programarea și întreținerea produsului poate fi realizată doar de către personal calificat.
- Instrucțiunile de instalare ale produsului trebuie citite integral, înainte de punerea în serviciu și exploatarea sa. În măsura în care ediția acestui manual nu este cea adecvată, identificați pe ultima copertă coordonatele distribuitorului local și pentru lămuriri suplimentare adresați-vă acestuia. Păstrați acest manual pentru referințe ulterioare.

⚠ ATENȚIE: Nu utilizați instalația în afara intervalului de funcționare indicat în instrucțiunile de operare. Nerespectarea acestui lucru se poate solda cu răni grave de persoane sau defectarea instalației.

- În măsura în care indicațiile cărții mașinii nu sunt suficient de lămuritoare, luați legătura cu reprezentantul Brooks Instrument pentru clarificarea problemei.
- Păstrați toate avertismentele, avizele și instrucțiunile livrate odată cu instalația sau inscripționate pe aceasta.

⚠ AVERTISMENT: Înainte de instalare, asigurați-vă că valorile nominale ale acestui instrument respectă codurile naționale. Nerespectarea acestui avertisment poate avea drept rezultat răni personale grave și/sau defectarea echipamentelor.

- Efectuați instalarea echipamentului în conformitate cu indicațiile de instalare corespunzătoare, respectiv cu respectarea prevederilor naționale. Echipamentul se conectează exclusiv la surse de energie electrică și de presiune corespunzătoare.
- Succesiv: (1) Presurizați lent instalația. Deschideți încetul cu încetul supapa de funcționare pentru evitarea fluctuațiilor de flux. (2) Controlați dacă nu sunt prelungeri la intrarea sau ieșirea debitmetrului de branșare. Dacă nu sunt scurgeri, presurizați instalația la presiunea de lucru.
- Înaintea exploatării/ întreținerii, verificați neapărat dacă conducta uzinală nu este sub presiune. În măsura în care este nevoie de piese de schimb, este neapărat necesar ca manevrarea pieselor de schimb să fie făcută de personal cu calificare profesională agreat de Brooks Instrument. Utilizarea altor piese de schimb decât cele originale și licențiate poate avea efecte asupra performanțelor instalației și asupra siguranței sale în exploatare. Utilizarea de piese asemănătoare de substituire poate avea ca rezultat pericol de incendiu și electrocutare.
- În toate cazurile toate ușile instalației trebuie să fie închise, cuștile de protecție să fie puse la locurile lor, pentru evitarea electrocutării și rănirii de persoane, exceptând situațiile când un specialist efectuează lucrări de întreținere.

⚠ ATENȚIE: În cazul instalațiilor cu flux de fluide, dacă din orice motiv este necesară închiderea valvelor de intrare și ieșire, limitrofe instalației, instalația trebuie complet golită. Neglijarea acestui lucru poate avea ca efect dilatarea termică a fluidului, care poate defecta instalația și poate produce răni de persoane.

Directiva europeană pentru instalațiile sub presiune (PED)

Toate instalațiile și sistemele presurizate ce se află sub presiuni interne ce depășesc 0,5 mbar (g) și au mai mult de 25 mm sau 1 țol, cad sub incidența noimei europene corespunzătoare (PED).

- La capitolul "Date tehnice" din cartea mașinii se găsesc indicațiile corespunzătoare directivei PED.
- Produsele menționate în cartea mașinii corespund directivei 2014/34/EU EU.
- Toate debitmetrele Brooks corespund clasei 1 de fluide.
- Produsele mai mari de 25 mm sau 1 țol corespund categoriei PED I, II sau III.
- Produsele mai mici de 25 mm sau 1 țol se conformează practicii ingineresti acceptate (SEP).

Directiva europeană privitoare la compatibilitatea electromagnetică (EMC).

Instalațiile (electrice /electronice) ce poartă marca Brooks Instrument CE îndeplinesc cu succes cerințele testelor de verificare ale compatibilității electromagnetice (Cf. directivelor europene EMC cu nr. 2014/30/EU).

În același timp trebuie acordată o atenție deosebită la alegerea cablurilor de semnalizare utilizate pentru instalațiile ce poartă marcajul CE.

Calitatea cablurilor de semnalizare, a legăturilor prin cablu și a conectoarelor:

Brooks Instrument oferă cabluri de calitate ridicată, care corespund cerințelor calitative ale CE.

În măsura în care folosiți cabluri proprii, trebuie alese acelea care sunt 100% ecranate și prevăzute cu filtre.

Conectoarele „D” sau cele „circulare” trebuie să dispună de ecrane metalice. În caz de nevoie trebuie folosite conectoare metalice pentru montarea filtrelor de cablu.

Filtrul de cablu trebuie conectat la carcasa metalică sau mașon și în ambele cazuri trebuie asigurată ecranarea la 360°. Ecranarea trebuie terminată cu o legare la pământ.

Conform standardului, conectoarele aparținând plăcilor electronice nu sunt metalice. Cablurile folosite trebuie să fie 100% ecranate și prevăzute cu filtre pentru a corespunde clasificării CE.

Ecranarea trebuie terminată cu o legare la pământ.

Configurație de contact: Vezi instrucțiunile de operare atașate.

Descărcare electrostatică (ESD)

⚠ ATENȚIE: Instalația include piese care sunt predispușe la defectare sub influența electricității statice. Trebuie respectate metodele corespunzătoare de extragere, instalare sau alte manipulări ale circuitelor electronice.

Procedură de manipulare:

1. Instalația trebuie scoasă de sub tensiune.
2. Înaintea de inserarea, scoaterea sau reglarea vreunei cartele electronice, sau a altui dispozitiv intern, persoana trebuie să se lege la pământ cu banda pentru articulația mâinii sau alte dispozitive de siguranță disponibile pentru acest scop.
3. Cartelele cu cablaje electronice imprimate trebuie transportate în ambalaje anti-electrostatice (conductive). Cartelele se pot scoate din ambalaj doar nemijlocit înaintea amplasării lor. Cartela demontată trebuie pusă neîntârziat în ambalajul de protecție în vederea transportării, a depozitării sau returnării la producător.

Observații:

În echipamente se găsesc adesea componente sensibile la descărcare electrostatică (ESD). Majoritatea echipamentelor moderne includ componente electronice realizate în tehnologie metal-oxid semiconductor (NMOS, SMOS, etc.) Experiența a dovedit că acestea pot fi afectate sau deteriorate chiar de energii electrostatice de slabă intensitate. Componentele defectate, cu toate că în aparență sunt funcționale, duc în timp la defecțiuni incipiente.

Slovak

Základné príkazy Prečítať pred inštaláciou!

Brooks Instrument svoje výrobky projektuje, vyrába a testuje takým spôsobom, aby tieto vyhovel domácim aj medzinárodným normám. Tieto zariadenia je potrebné predpísaným spôsobom inštalovať, prevádzkovať a udržiavať, na zabezpečenie ich spoľahlivej a normálnej prevádzky v celom pracovnom rozsahu. Nižšie uvedené príkazy je potrebné dodržiavať a začleniť do programu bezpečnostných predpisov v priebehu inštalácie, prevádzky a údržby výrobkov Brooks Instruments.

- V záujme zabezpečenia vyhovujúceho výkonu inštaláciu, prevádzku, programovanie, aktualizáciu a údržbu zariadení má vykonávať výlučne odborne kvalifikovaný personál.
- Pred inštaláciou, prevádzkou a servisom zariadení je potrebné prečítať všetky príkazy. Ak táto príručka nie je správna, tak na zadnej strane treba nájsť miestneho distribútora, kontaktovať ho pre ďalšie informácie. Pre neskoršie informácie uschovajte príručku.

⚠ UPOZORNENIE: Neprevádzkovať zariadenie v rozsahu mimo rozsahu uvedenom v prevádzkovej príručke. Porušenie tohto oznámenia môže mať za následok ťažkú ujmu na zdraví a vedie k poškodeniu zariadenia.

- Ak príkazy v návode nie sú jednoznačné, kontaktujte zástupcu Brooks Instrument na objasnenie problémov.
- Dodržujte všetky upozornenia, príkazy a usmernenia uvedené na zariadení, alebo s ním dodané.

⚠ VAROVANIE: pred montážou sa uistite, že toto zariadenie disponuje potrebnými klasifikáciami povolení, ktoré spĺňajú miestne a národné predpisy. Nedodržanie tohto varovania môže mať za následok vážne zranenia osôb alebo poškodenie zariadenia.

- Zariadenia inštalujte podľa návodu uvedeného v príkaze na inštaláciu, v súlade s miestnymi a národnými predpismi. Zariadenie pripojte výlučne len na vyhovujúci elektrický a tlakový zdroj
- Postup: (1) Pomaly natlakujte systém. Prevádzkový ventil otvorte pomaly na zamedzenie kolísania prietoku. (2) Prekontrolujte tesnosť vstupného a výstupného zapojenia prietokomeru. Keď nie je presakovanie, spoje sú tesné, naplniť systém na prevádzkový tlak.
- Pred vykonávaním servisných prác kontrolovať, či systém nie je pod tlakom. V prípade, že je potrebná výmena súčiastky, výmenu dielov, určených Brooks Instrument musí vykonať kvalifikovaná osoba. Použitie nepovolených dielov a vykonávanie nepovolených aktivít ohrozujú bezpečnosť prevádzky a majú negatívny vplyv na výkon zariadenia. Nahradenie súčiastok len podobnými komponentmi môže mať za následok požiar, úraz elektrickým prúdom alebo nedostatočnú funkciu zariadenia
- Všetky ochranné kryty, dvierka zariadenia majú byť zatvorené na zabezpečenie ochrany proti úrazu elektrickým prúdom a proti poraneniam obsluhy. Výnimku tvorí vykonávanie údržby kvalifikovaným odborníkom.

⚠ UPOZORNENIE: Pri zariadeniach s prietokom kvapalín, keď z akéhokoľvek dôvodu je nutné uzavrieť vstupné a výstupné ventily, zariadenie je potrebné úplne vyprázdniť. Zanedbanie vypúšťania má za následok poškodenie zariadenia s možnosťou zranenia obsluhy z dôvodu teplej roztlačenej náplne.

Európska smernica vzťahujúca sa na tlakové zariadenia (PED)

- Všetky zariadenia s vyšším vnútorným pretlakom ako 0,5 bar (g), a väčšieho rozmeru ako 25 mm alebo 1 anglický palec, podliehajú pod Európsku smernicu vzťahujúcu sa na tlakové nádoby (PED).
- Kapitola "Technické údaje" návodu na obsluhu obsahuje príkazy vzťahujúce sa na smernicu PED.
- Produkty uvedené v návode na obsluhu vyhovujú smernici 2014/34/EU EÚ.
- Všetky prietokomery Brooks patria do 1. skupiny kvapalín.
- Produkty presahujúce rozmery 25 mm alebo 1 " spĺňajú I., II., alebo III. kategóriu PED.
- Produkty menšie alebo rovné ako 25 mm alebo 1 " zodpovedajú zaužívanej meracej praxi (SEP).

Európska smernica vzťahujúca sa na elektromagnetickú kompatibilitu (EMC)

Elektrické / elektronické zariadenia Brooks Instrument, ktoré si zaslužili značku CE, úspešne splnili skúšobné testy požiadaviek elektromagnetickej kompatibility (smernica EMC č. 2014/30/EU).

Pritom treba venovať zvláštnu starostlivosť na výber signálnych káblov zariadenia, s označením CE.

Kvalita signálnych káblov, káblových spojov a pripojov:

Brooks Instrument ponúka vysoko kvalitné káble, ktoré spĺňajú požiadavky kvalitatívneho zaradenia CE.

Ak použijete vlastné signálne káble, majú mať 100%-né tienenie, s plným filtrovaním.

Pripojky "kruhové" alebo tvaru "D" majú mať kovové tienenie. V prípade potreby treba použiť kovové káblové spojky k upevneniu káblového filtra.

Káblový filter treba pripojiť ku kovovému telesu alebo k puzdru, na oboch stranách zabezpečiť tienenie v kruhu 360 °. Tienenie má byť ukončené uzemnením.

Pripojky vedúce ku kartám podľa noriem sú nekovové. Použitie káble, pre vyhovenie predpisom CE musia mať 100%-né filtrovanie tienením.

Tienenie má byť ukončené uzemnením.

Konfigurácia kontaktov: Viď priložený návod na obsluhu. .

Elektrostatický výboj (ESD)

⚠ UPOZORNENIE: Prístroj obsahuje súčiastky, ktoré môžu byť poškodené od elektrostatických nábojov. Pri montáži, odstraňovaní alebo inej údržbe vnútorných obvodových kariet je potrebné dodržiavať príslušné postupy.

Postup ošetrovania:

1. Zariadenie odpojiť od napájania.
2. Osoba vykonávajúca údržbu má byť uzemnená uzemňujúcim náramkom, alebo iným, na túto prácu vyhovujúcim spôsobom pred vykonávaním inštalácie, demontáže a nastavenia obvodových kariet alebo iného vnútorného prostriedku.
3. Karty obvodov sa musia prepravovať v elektricky vodivom balení. Karty sa môžu vyberať z ochranného obalu výlučne len tesne pred montážou, zasunutím! Vybranú kartu okamžite treba umiestniť do ochranného obalu, určeného pre dopravu, skladovanie, alebo pre spätnú prepravu do výrobného závodu.

Poznámky:

Existencia prvkov, ktoré sú citlivé na elektrostatické výboje (ESD) v prístroji je častým javom. U väčšiny moderných elektronických prostriedkov sú použité prvky s technológiou oxidu kovov (NMOS, SMOS, atď.). Skúsenosti dokazujú, že aj nepatrné elektrostatické výboje poškodzujú, zničia tieto prostriedky. Poškodené súčiastky, aj keď zdánlivo pracujú bez chyby, odkazujú na vznikajúce poruchy.

GF100 Series

Slovene

Osnovna navodila

Preberite jih pred nadaljevanjem.

Brooks Instrument oblikuje, proizvaja in preskuša svoje izdelke tako, da ustrezajo številnim nacionalnim in mednarodnim standardom. Te izdelke je treba ustrezno namestiti, jih uporabljati in vzdrževati, saj bodo le tako še naprej delovali v skladu s svojimi običajnimi tehničnimi podatki. Upoštevajte spodnja navodila in jih vključite v svoj varnostni program pri namestitvi, uporabi in vzdrževanju izdelkov družbe Brooks Instrument.

- Če želite zagotoviti ustrezno delovanje, zagotovite, da bo izdelek namestilo, uporabljalo, posodabljalo, programiralo in vzdrževalo usposobljeno osebje.
- Pred namestitvijo, uporabo in servisiranjem izdelka preberite vsa navodila. Če ta priročnik ni ustrezen priročnik, na hrbtni strani poiščite podatke za stik z lokalnim prodajnim mestom. Ta priročnik shranite za poznejšo uporabo.

▲ OPOZORILO: To napravo lahko uporabljate samo v okviru tehničnih podatkov, ki so navedeni v priročniku z navodili za uporabo. Če tega opozorila ne upoštevate, lahko pride do hudih telesnih poškodb in/ali poškodb opreme.

- Če katerih koli navodil ne razumete, se za pojasnilo obrnite na svojega zastopnika družbe Brooks Instrument.
- Upoštevajte vsa opozorila, svarila in navodila, ki so navedena na izdelku ali so mu priložena.

▲ OPOZORILO: Pred namestitvijo se prepričajte, da ima ta naprava zahtevane ocene odobritve, ki izpolnjujejo lokalne in nacionalne zakone. Če tega opozorila ne upoštevate, lahko pride do hudih telesnih poškodb in/ali poškodb opreme.

- Opremo namestite v skladu z navodili za namestitev, ki so navedena v ustreznem uporabniškem priročniku, ter v skladu z veljavnimi lokalnimi in nacionalnimi zakoni. Vse izdelke priključite na ustrezne električne vire in vire tlaka.
- Postopek: (1) V sistemu počasi zaženite pretok. Počasi odprite procesne ventile, da preprečite nihanja pretoka. (2) Preverite, ali prihaja do puščanj okrog vhodnih in izhodnih priključkov merilnika pretoka. Če ne prihaja do puščanj, vzpostavite delovni tlak v sistemu.
- Pred servisom morate odstraniti tlak v obdelovalni liniji. Če potrebujete rezervne dele, zagotovite, da usposobljeno osebje uporablja rezervne dele, ki jih je odobrila družba Brooks Instrument. Neodobreni deli in postopki lahko vplivajo na učinkovitost delovanja izdelka ali ogrozijo varno upravljanje postopka. Rezervni deli, ki so podobni samo na videz, lahko povzročijo požar, nevarnost električnega udara ali nepravilno delovanje.
- Prepričajte se, da so vrata vrata naprave zaprta in da so zaščitni pokrovi nameščeni, da preprečite električni udar in telesne poškodbe, razen kadar usposobljeno osebje izvaja vzdrževalna dela.

▲ OPOZORILO: Če je pri napravah za pretok tekočine vhodne in izhodne ventile ob napravi treba iz kakršnega koli razloga zapreti, je treba naprave popolnoma izprazniti. Če tega ne naredite, lahko pride do toplotnega raztezanja tekočine, zaradi katerega se lahko naprava prelomi in povzroči telesne poškodbe.

Evropska direktiva o tlačni opre (PED)

Vsa tlačna oprema z notranjim tlakom, ki je večji od 0,5 bara (g), in velikostjo, ki je večja od 25 mm ali 1 palca, spada v direktivo o tlačni opre (PED).

- V poglavju »Tehnični podatki« v tem priročniku najdete navodila, ki se nanašajo na direktivo PED.
- Izdelki, opisani v tem priročniku, so skladni z direktivo EN 2014/34/EU.
- Vsi merilniki pretoka družbe Brooks Instrument spadajo v skupino tekočin 1.
- Izdelki, večji od 25 mm ali 1 palca, so skladni s kategorijo I, II, ali III direktive PED.
- Izdelki, katerih velikost je 25 mm ali 1 palec ali manjši izdelki, so skladni z dobro inženirsko prakso (SEP).

Evropska direktiva o elektromagnetni združljivosti (EMC)

Naprave družbe Brooks Instrument (električne/elektronske) z oznako CE so bile uspešno preskušene v skladu s predpisi direktive o elektromagnetni združljivosti (Direktiva o elektromagnetni združljivosti 2014/30/EU).

Posebno pozornost morate nameniti izbiri signalnega kabla, ki jih uporabljate za naprave z oznako CE.

Kakovost signalnih kablov, kabelskih tesnil in priključkov:

Brooks Instrument ponuja kable visoke kakovosti, ki ustrezajo tehničnim podatkom za pridobitev oznake CE.

Če uporabljate svoj signalni kabel, morate uporabiti kabel, ki je na splošno popolnoma oklopljen s 100 % zaščito.

Priključki tipa »D« ali »krožni« priključki morajo biti zaščiteni s kovinskim ščitom. Po potrebi je treba uporabiti kovinske kabelske tesnilke, ki zagotavljajo vpenjala za zaslon kabla.

Zaslon kabla je treba priključiti na kovinsko ohišje ali tesnilko in ga na obeh koncih popolnoma zaščititi.

Zaščito je treba prekiniti pri ozemljitvi.

Robni priključki običajno niso kovinski. Kable je treba zaščititi s 100 % zaščito, da ustrezajo oznaki CE.

Zaščito je treba prekiniti pri ozemljitvi.

Navodila z konfiguracijo nožic najdete v priloženem uporabniškem priročniku.

Elektrostatična razelektritev (ESD)

▲ OPOZORILO: Naprava vsebuje elektronske komponente, ki so občutljive na poškodbe zaradi statične elektrike. Pri odstranitvi, namestitvi ali drugih postopkih uporabe notranjega tiskanega vezja ali naprav morate upoštevati ustrezne postopke.

Postopek ravnanja:

1. Izklopite napravo.
2. Osebje je treba pred namestitvijo, odstranitvijo ali prilagajanjem katere koli kartice tiskanega vezja ali druge notranje naprave ozemljiti z zapetnim paščkom ali drugimi varnostnimi in primernimi sredstvi.
3. Kartice s tiskanim vezjem je treba prevažati v prevodnem vsebniku. Plošče lahko iz zaščitne embalaže odstranite šele tik pred namestitvijo. Odstranjene plošče je treba takoj shraniti v zaščitno embalažo za prevoz, shranjevanje ali vračilo v tovarno.

Opombe:

Ta naprava ni edinstvena z vidika komponent, ki so občutljive na elektrostatično razelektritev. Večina sodobnih elektronskih naprav vsebuje komponente, ki uporabljajo oksidno tehnologijo (NMOS, SMOS itd.). Izkušnje dokazujejo, da lahko celo majhne količine statične elektrike poškodujejo ali uničijo te naprave. Poškodovane komponente se predčasno okvarijo, čeprav navidez delujejo pravilno.

Spanish

Instrucciones básicas

¡Léalos primero!

El Brooks Instrument proyecta, fabrica y prueba sus productos de manera que éstos respondan a numerosas normas nacionales e internacionales. Dichas instalaciones deben ser emplazadas, operadas y mantenidas adecuadamente, para que puedan marchar de todas formas en conformidad con el alcance normal de funcionamiento. Las siguientes instrucciones deben cumplirse y incorporadas en su programa de seguridad cuando instalando, operando y mantenimiento los productos Brooks Instrument.

- Para asegurar el adecuado rendimiento, para instalar, operar, actualizar, programar y mantener tiene que realizarse exclusivamente por una persona calificada.
- Antes de la instalación, operación y servicio del producto leer todas las respectivas instrucciones. Si el presente manual no es la adecuada publicación, busque al distribuidor local que figura en la contraportada y póngase en contacto con él para obtener informaciones. Guarde el presente manual para tener informaciones también en el futuro.

⚠ ATENCIÓN: No haga funcionar los equipos fuera del rango indicado en las instrucciones de funcionamiento. El incumplimiento de estas últimas puede conducir a graves daños personales o a la avería del equipo.

- Si las instrucciones del manual no son evidentes, póngase en contacto con el representante de Brooks Instrument para aclarar el problema
- Observar todas las alertas, advertencias e instrucciones indicadas en el equipo o suministradas con el mismo.

⚠ ADVERTENCIA: Antes de la instalación, asegúrese de que el instrumento ofrece las características de aprobación necesarias para satisfacer los requisitos normativos locales y nacionales. En caso contrario, se pueden producir lesiones personales y/o daños en el equipo.

- Instale su equipo en conformidad con las recomendaciones indicadas en las respectivas instrucciones de instalación y con las pautas de las normas vigentes locales e internacionales. Conectar el producto exclusivamente a la adecuada fuente eléctrica y presión.
- Proceso: (1) Colocar lentamente flujo en el sistema. Abrir lentamente las válvulas de proceso para evitar oscilación del flujo. (2) Verificar si hay fuga alrededor de las conexiones de entrada y salida del flujómetro, Si no hay, llenar el sistema con la presión de operación.
- Antes de efectuar el servicio, verificar si hay presión o no en la tubería de la red. Si se requiere realizar un recambio de piezas, solamente el personal calificado puede manipular las piezas de repuesto determinadas por Brooks Instrument Las piezas y operaciones no autorizadas pueden afectar el rendimiento del producto o arriesgar el funcionamiento seguro. El recambio realizado con piezas sólo similares pueden traer como consecuencias incendios, choques eléctricos o funcionamiento bajo.
- Todas las puertas de la instalación deben estar cerradas, las cubiertas de protección tienen que hallarse en el debido sitio con el fin de evitar los daños personales y los choques eléctricos, salvo cuando un especialista efectúa el mantenimiento.

⚠ ADVERTENCIA: En caso de instalaciones que circulen líquido, si por cualquier razón se hubiera de cerrar las válvulas de entrada y salida situadas al lado del equipo, dichas instalaciones deberán ser completamente vaciadas. La omisión de esto último puede provocar la dilatación térmica del líquido, lo que puede dañar al equipo y conducir a daños personales.

Directriz Europea de los Equipos de Presión (PED)

Todos los equipos de presión, con una presión interna que supere a 0,5 bar (g) con tamaño mayor a 25 mm o 1 pulgada entran el ámbito de la Directriz Europea de los Equipos de Presión (PED).

- El capítulo Datos Técnicos del manual incluye las instrucciones respecto a las directivas de PED
- Los instrumentos de medición indicados en el Manual responden a las EN directivas 2014/34/EU.
- Todos los caudalímetros Brooks pertenecen a la categoría 1 del grupo de fluidos.
- Los instrumentos de medición más grandes que 25 mm o 1 pulgada están en conformidad con las categorías I, II o III de PED
- Los instrumentos de medición más pequeños que 25 mm o 1 pulgada siguen la Práctica Aceptada de Ingeniería (SEP).

Directriz Europea respecto a la Compatibilidad Electromagnética (EMC)

Las instalaciones de Brooks Instrument (eléctricas/electrónicas) merecedores de la categoría CE cumplieron con éxito las pruebas que verifican las exigencias de la compatibilidad electromagnética (directiva de EMC 2014/30/EU).

Al mismo tiempo se ha de prestar una especial atención en la selección de los cables de señal, utilizados con los equipos marcados con CE.

Calidad de los cables de señal, piezas de unión de cable y conectores:

El Brooks Instrument ofrece cables de alta calidad, que responden a los requerimientos de calificación CE.

Si se utiliza cable propio de la firma, se ha de elegir uno que sea completamente filtrado con blindaje de 100%.

Las piezas de unión de forma „D” o „circular” deben ser blindadas mediante blindaje metálica. Si es necesario, aplicar piezas de unión de metal para sujetar el filtro de cable.

Conectar el filtro de cable a la caja o manguito de metal blindándolo en ambas caras en 360°.

El blindaje debe terminar en tierra.

Los conectores que pertenecen a las tarjetas normalmente no son metalizados. Los cables utilizados deben ser filtrados con una blindaje de 100% para responder a la calificación CE.

El blindaje debe terminarse en tierra.

Configuración de contacto: Véase Instrucciones de operación adjuntas.

Descarga Electroestática (ESD)

⚠ PRECAUCIÓN: El aparato incluye piezas electrónicas que son susceptibles a los daños provocados por la electricidad estática. Observar los adecuados procesos para remover, instalar o manipular las tareas y medios de circuitos eléctricos internos

Proceso de operación:

1. Desconectar la fuente eléctrica de la unidad.
2. La persona debe ponerse a tierra mediante una palanca acodada o por otro medio seguro y apropiado para dicho fin antes de instalar, sacar o ajustar el circuito impreso eléctrico u otro medio interno.
3. El circuito impreso debe ser transportado en embalaje conductor. Las tarjetas no pueden sacarse de la cubierta protectora exclusivamente directamente antes de la instalación. Las tarjetas desmontadas deben colocarse sin tardar en el embalaje protector utilizado para manipulación, almacenamiento o devolución a la fábrica.

Notas:

Este equipo no es el único contenido de piezas susceptibles a la descarga electroestática (ESD). En la mayoría de los medios electrónicos modernos se encuentran piezas fabricadas por tecnología de óxido metálico. (NMOS, SMOS etc.). Las experiencias confirman que incluso una mínima electricidad estática puede dañar o destruir dichos medios. Las piezas averiadas, aunque funcionen aparentemente bien, indican una falla inicial.

GF100 Series

Swedish

Väsentliga anvisningar. Läs detta innan du fortsätter!

Brooks Instrument konstruerar, tillverkar och testar sina produkter med syfte att uppfylla alla nationella och internationella standarder. Dessa produkter måste installeras på rätt sätt, handhas och underhållas för att de skall fungera kontinuerligt enligt deras normala specifikation. De följande anvisningarna bör följas och integreras till Ert säkerhetsprogram varje gång när Brooks Instruments produkter installeras, handhas och underhålls.

- För att garantera angiven funktion, använd kvalificerad personal till att installera, handha, uppdatera, programmera och serva produkten.
- Läs alla instruktioner innan produkten installeras, startas upp och underhålls. Om du finner att denna instruktionshandbok inte är den rätta instruktionsboken, titta på i slutet av pärmen för information om hur man kan kontakta lokala representanter. Spara denna instruktions manual för senare behov.

▲ WARNING: Kör inte detta instrument utanför dess specifikationer som är angiven i Instruktionsboken. Undvikande att ta denna varning kan leda till allvarliga personliga skador och / eller skada utrustningen.

- Om du inte förstår någon av dessa instruktioner, kontakta din representant för Brooks Instrument för klarläggande.
- Följ alla varningar och instruktioner som följer med leveransen av denna produkt.

▲ WARNING: Säkerställ före installation att detta instrument har alla nödvändiga godkännanden för att uppfylla lokala och nationella regler. Underlåtenhet att följa denna varning kan leda till personskador och/eller skador på utrustningen.

- Installera din utrustning på sättet som anges i den gällande handbokens installationsanvisningar och enligt tillämpliga lokala och nationella föreskrifter. Koppla varje produkt till föreskriven ström- och tryckkällan.
- Igångsättning: (1) Koppla långsamt på flöde i systemet. Öppna processventiler sakta för att undvika för höga flöden. (2) Kontrollera läckor vid mätarens anslutningar för in- och utlopp. Om inget läckage förekommer, kör systemet upp till drifttrycket.
- Kontrollera att processledningens tryck är bortkopplat före service. I fall det behöves kompletteras med nya delar, se till att komponenter föreskrivna av Brooks Instrument används. Samt att kvalificerad personal utför arbetet. Ej rekommenderade komponenter och åtgärder kan påverka produktens prestanda och sätta din driftsäkerhet på spel. "Felaktiga" ersättningar kan orsaka eld, elektriska skador samt felaktig funktion.
- Se till att anordningens kåpor och skyddslock ligger på sin plats med syfte att förebygga elektriska kontakt och personliga skador; det enda undantag gäller när underhållsarbete utförs av kvalificerad personal.

▲ WARNING: I fall av - flödesmätare / regulatorer för vätskor: Ifall ventiler före och efter skall stängas av, måste alla ledningar tömmas på all vätska. Att ej tömma ledningar alt koppla bort trycket kan göra så att vätskans värmeutvidgning kan spräcka / skada utrustningen och orsaka personliga skador.

European Pressure Equipment Directive (PED) - (Rådets Direktiv 99/36/EG av den 29 april 1999[1] om transportabla tryckbärande anordningar)

Alla utrustning för tryck med ett tryck över 0.5 Bar(g) bar och större dimensioner än 25 mm eller 1" (inch) faller under Tryck direktiv 99/36/EG av den 29 april 1999[1] om transportabla tryckbärande anordningar - PED.

- Den här Instruktionsbokens Sektion " Specifikation" innehåller anvisningar gällande PED Direktivet.
- Mätare som beskrivs i denna Instruktionsbok är i överensstämmelse med EN Direktivet 2014/34/EU.
- Brooks Instruments alla flödesmätare faller under flödesgrupp nr. I.
- Mätare som är större än 25 mm eller 1" (inch) överensstämmer med PED kategorier I, II eller III.
- Mätare på 25mm eller 1" (inch) eller mindre faller under Sound Engineering Practice (SEP) (God Teknisk Praxis).

European Electromagnetic Compatibility (EMC) - Elektromagnetisk kompatibilitet

Brooks Instrument (elektriska/elektroniska) CE-märkta anordningar har redan genomgått ett framgångsrikt prov enligt regleringar under Electromagnetic Compatibility (EMC directive 2014/30/EU). Man måste dock ägna särskild uppmärksamhet till valet av signalkabeln som skall användas för CE-märkta anordningar.

Signalkablars, packboxars och kontaktdons kvalitet:

Brooks Instrument levererar högkvalitativa kablar som överensstämmer med specifikation för CE-intygade produkter.

Om man använder sin egen signalkabel, då bör man använda en kabel som är fullständigt skärmad med en 100% avskärmning.

"D" eller "Cirkelformiga" kontaktdon skall vara skärmade med metalliska avskärmningar. Om det är användbart, bör metallpackboxar som ger en bra fastspänning för kabelskärmar användas.

Kabelavskärmningen måste kopplas till den metalliska skärmande anordningen eller packboxen och skärmas vid båda ändar runt omkring.

Avskärmningens avspänning måste jordas.

Card Edge Kontaktdon är icke metalliska. För att överensstämma med krav på CE-intyg, skall de kablarna som används vara skärmade med 100% skärmning.

Skärmningen måste jordas.

Vad gäller stiftkonfigurationen: Se den bifogade Instruktionshandboken.

ESD (Elektrostatiska urladdningar)

▲ OBS: Denna utrustning innehåller elektroniska komponenter som är lättpåverkade av skada orsakad av statisk elektricitet. Lämplig hanteringsprocedur måste följas när man tar bort, installerar eller på något annat sätt hanterar inre kretskort eller andra anordningar.

1. Ström till enheten måste kopplas från.
2. Personalen måste jordas med hjälp av ett armband eller något annat säkert medel innan något kretskort eller andra inre anordningar installeras, tas bort eller justeras.
3. Kretskort måste transporteras i en speciell förpackning för elektronik. Kort skall ej tas bort från deras skydsskåpa innan man skall installera dem. De borttagna korten bör omedelbart läggas i speciell förpackning för transport, lagring eller återlämnande till fabriken.

Anmärkningar:

Dessa instrument är ej unika vad gäller dess ESD (Elektrostatiska urladdningar) - känsliga komponenter. De flesta samtida konstruktioner innehåller komponenter som utnyttjar metalloxd teknologi (NMOS, SMOS, o.s.v.). Erfarenhet har visat att även små mängder av statisk elektricitet kan skada eller förstöra dess komponenter. Skadade komponenter - även om de annars verkar fungera ordentligt - har ofta en kortare livslängd.

*THIS PAGE WAS
INTENTIONALLY
LEFT BLANK*

GF100 Series

LIMITED WARRANTY

Visit www.BrooksInstrument.com for the terms and conditions of our limited warranty.

BROOKS SERVICE AND SUPPORT

Brooks is committed to assuring all of our customers receive the ideal flow solution for their application, along with outstanding service and support to back it up. We operate first class repair facilities located around the world to provide rapid response and support. Each location utilizes primary standard calibration equipment to ensure accuracy and reliability for repairs and recalibration and is certified by our local Weights and Measures Authorities and traceable to the relevant International Standards.

Visit www.BrooksInstrument.com to locate the service location nearest to you.

START-UP SERVICE AND IN-SITU CALIBRATION

Brooks Instrument can provide start-up service prior to operation when required.

For some process applications, where ISO-9001 Quality Certification is important, it is mandatory to verify and/or (re)calibrate the products periodically. In many cases this service can be provided under in-situ conditions, and the results will be traceable to the relevant international quality standards.

CUSTOMER SEMINARS AND TRAINING

Brooks Instrument can provide customer seminars and dedicated training to engineers, end users and maintenance persons.

Please contact your nearest sales representative for more details.

Due to Brooks Instrument's commitment to continuous improvement of our products, all specifications are subject to change without notice.

TRADEMARKS

Brooks and MultiFlo are trademarks of Brooks Instrument, LLC
All other trademarks are the property of their respective owners.



Global Headquarters

Brooks Instrument
407 West Vine Street
Hatfield, PA
19440-0903 USA

Toll-Free (USA): 888-554-FLOW
T: 215-362-3500
F: 215-362-3745

BrooksAM@BrooksInstrument.com

A list of all Brooks Instrument locations and contact details can be found at www.BrooksInstrument.com

Installation and Operation Manual

X-DPT-RS485-GF100-Series-MFC-eng

Part Number: 541B183AAG

March, 2013

RS485 L-Protocol Supplemental Manual for GF100 Series Mass Flow Controllers and Meters

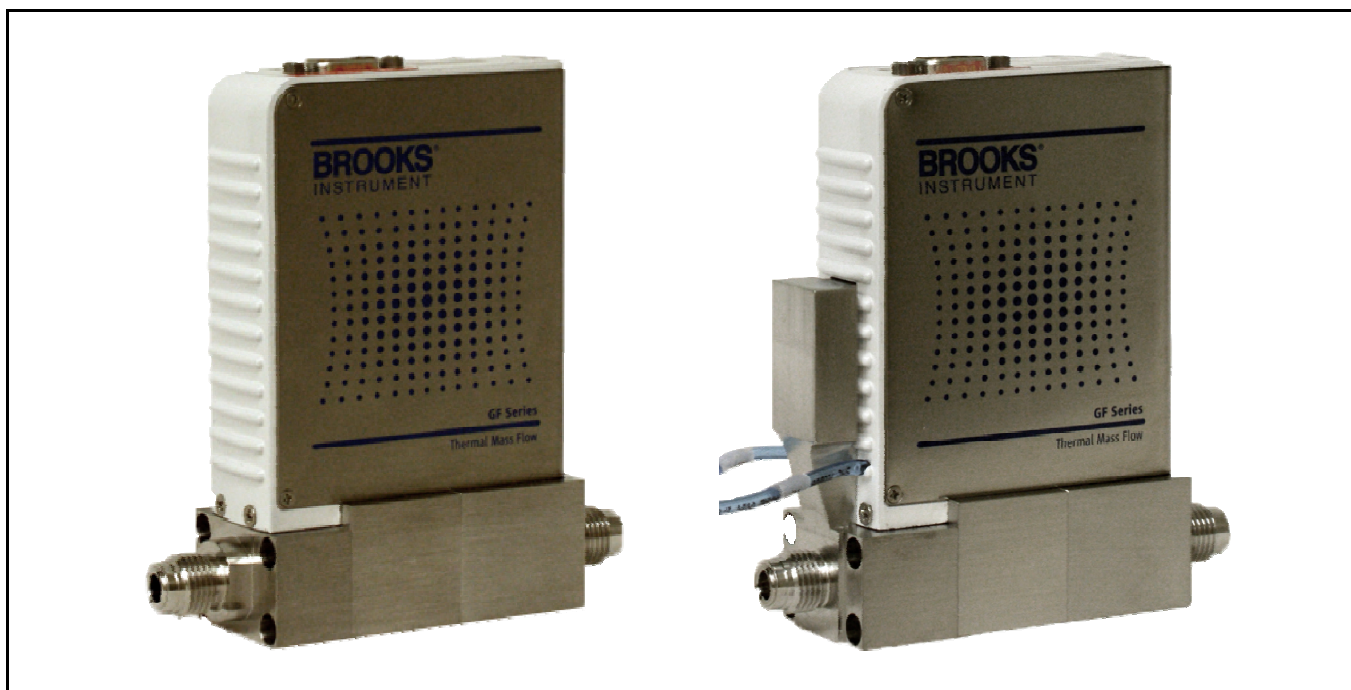

Brooks® GF125 Series and GF135 Series

Brooks RS485 L-Protocol MFCs

Dear Customer,

We recommend that you read this manual in its entirety as this will enable efficient and proper use of the RS485 L-Protocol Mass flow controllers and meters. Should you require any additional information concerning the RS485 L-Protocol Mass flow controllers and meters, please feel free to contact your local Brooks Sales and Service Office; see back cover for contact information, or visit us on the web at www.BrooksInstrument.com. We appreciate this opportunity to service your fluid measurement and control requirements, and trust that we will be able to provide you with further assistance in future.

Yours sincerely,

Brooks Instrument

Contents

1. Introduction.....	1
1.1. Purpose.....	1
1.2. Scope.....	1
2. Background.....	3
2.1. Topology	3
2.2. Communication Parameters	3
2.3. Message Format	4
3.13. Auto Zero Enable/Disable.....	26
3.14. Requested Zero Enable.....	27
3.15. Query for Requested Zero Status	28
3.16. Query for Sensor Current Zero	30
3.17. Query for Sensor Reference Zero	32
3.18. Set Sensor Reference Zero	34
3.19. Set Default Control Mode	35
3.20. Query Default Control Mode	36
4. Software Design Requirement	39
4.1. Normal Transaction Scenarios.....	39
4.1.1. Read Transaction Scenario	39
4.1.2. Write Transaction Scenario	40
4.2. Abnormal Transaction Scenarios.....	40
4.2.1. Read Transaction Scenario	40
4.2.1.1. Packet Error	40
4.2.1.2. Read Error	41
4.2.2. Write Transaction Scenario.....	42
4.2.2.1. Packet Error	42
4.2.2.2. Write Error.....	42
4.3. Protocol Timing	43
4.4. Message Sequence between Master Controller and a MFC Slave Controller.....	44
4.5. MFC New Setpoint Conversion.....	45
4.6. Sensor Zero Filter	45
4.6.1. Requested Zero	46
4.6.2. Auto Zero	46
4.7. Calibration Instances	47

Brooks RS485 L-Protocol MFCs

4.8. Analog / Digital Mode	47
5. Advanced Diagnostics (GF135 Only).....	49
5.1. New Communication Protocol Overview	49
5.1.1. Objectives and Problem Statement	49
5.1.2. Protocol Description	49
5.2. Specific Requirements	50
5.2.1. Introduction	50
5.2.2. Advanced Protocol	50
5.2.3. New Attributes	50
5.3. Tool – Device Communication	53
6. Appendix: Tool - Device Communication	55

1. Introduction

1.1. Purpose

The purpose of this document is to outline the generic RS485 multi-drop communication protocol for UNIT digital MFC.

1.2. Scope

This protocol is intended to serve all digital MFCs. Only the following messages are supported:

- Query for MAC – Master controller will use this message to query the existence of a MFC controller.
- Digital mode selection – Master controller will use this message to set a MFC controller to digital mode.
- Freeze Follow – Master controller will use this message to configure a MFC controller to act upon a new set point when received.
- Set Point – Master controller will use this message to send a new set point to a MFC controller.
- Ramp Time – Master controller will use this message to send a ramp time to a MFC controller.
- Filtered Set Point – Master controller will use this message to get the current set point from a MFC controller.
- Indicated Flow - Master controller will use this message to get the current flow reading from a MFC controller.
- Valve Drive Current - Master controller will use this message to get the valve drive current.
- Calibration Instance (Process Gas) Selection - Master controller will use this message to select which calibration instance is to be used for flow metering.
- Query for Calibration Instance (Process Gas) Selected - Master controller will use this message to query the selected calibration instance, which is currently being used for flow metering.

Brooks RS485 L-Protocol MFCs

- Query for Available Calibration Instances (Process Gases) - Master controller will use this message to query available number of calibration instances.
- Auto Zero Enable/Disable - Master controller will use this message to enable auto zero function.
- Requested Zero Enable - Master controller will use this message to enable requested function.
- Query for Requested Zero Status – Master controller will use this message to query if the requested zero function has been completed.
- Query for Sensor Current Zero - Master controller will use this message to query the current sensor zero offset.
- Query for Sensor Reference Zero - Master controller will use this message to query the sensor reference zero offset.
- Set Sensor Reference Zero - Master controller will use this message to set sensor reference zero offset.

2. Background

2.1. Topology

The controller acts as a Master device on an RS-485 multi-drop bus. It controls all transactions on the bus.

The digital MFC controller (up to 15) acts as a slave device on an RS-485 multi-drop bus. It continually listens for transaction requests from the Master controller, processes requests addressed to it, and sends replies as needed.

[[Will need to recreate the block diagram on p. 4]]

2.2. Communication Parameters

- BAUD rate: 9600, 19200, 38400, 57600
- Data bits: 8 ☆ Start bit: 1 ☆ Stop bit: 1 ☆ Parity: none
- Byte order: LSB first
- MAC(Address) assignment:
- Master controller: 0
 - Digital MFC controller 1-15: 0x21(33) – 0x2F(47)
 - Broadcast packet address: 0xFF(255)
 - Addresses 0x01 to 0x1f are reserved for bus control characters
 - ACK – 0x06
 - NAK – 0x16

Brooks RS485 L-Protocol MFCs

2.3. Message Format

Messages on the bus are sent as packets with a fixed format, illustrated as the following diagram. Each packet begins with the target digital MFC controller MAC ID (address), an STX character (0x02), a service (command) code (0x80 for read and 0x81 for write), a packet length character, a variable identifier (consisting of Class ID, Instance ID, Attribute ID) and a data count between 0 to 2. Each packet ends with a pad byte of 0, and a 1-byte checksum, which is the sum of all of the bytes in the packet, other than the target MAC ID, modulo 256. The checksum calculation discards the carry from the byte summation calculation. This message structure resembles with the one used by DeviceNet protocol.

STX(0x02)
Command Code(0x80 for read, 0x81 for write)
Packet Length
Class ID
Instance ID
Attribute ID
Data(0 - 2 bytes)
Pad(0x00)
Checksum

All communication on the bus is done by service requests (from Master controller to a specified MFC slave controller), each addressed to a specific MAC ID, Class ID, Instance ID and Attribute ID. Currently this protocol supports only 2 services – Read and Write.

All communication on the bus is done by service requests (from Master controller to a specified MFC slave controller), each addressed to a specific MAC ID, Class ID, Instance ID and Attribute ID. Currently this protocol supports only 2 services – Read and Write.

The following table summarizes the specification of Class ID, Instance ID and Attribute ID for each supported message:

Message	Class ID	Instance ID	Attribute ID
Query for MAC ID	0x03	0x01	0x01
Digital Mode Selection	0x69	0x01	0x03
Query for Present Control Mode	0x69	0x01	0x03
Freeze Follow	0x69	0x01	0x05
New Setpoint	0x69	0x01	0xA4
Ramp Time	0x6A	0x01	0xA4
Filtered Setpoint	0x6A	0x01	0xA6
Indicated Flow	0x6A	0x01	0xA9
Valve Drive Current	0x6A	0x01	0xB6
Calibration Instance	0x66	0x00	0x65
Query for Calibration Instance	0x66	0x00	0x65
Query for Available # of Calibration Instances	0x66	0x00	0xA0
Auto Zero Enable/Disable	0x68	0x01	0xA5
Requested Zero Enable	0x68	0x01	0xBA
Query for Requested Zero Status	0x68	0x01	0xBA
Query for Sensor Current Zero	0x68	0x01	0xA9
Query for Sensor Reference Zero	0x68	0x01	0xAA
Set Sensor Reference Zero	0x68	0x01	0xAA
Set Default Control Mode	0x69	0x01	0x04
Query for Default Control Mode	0x69	0x01	0x04
Set MAC ID (Hardware Dependant)	0x03	0x01	0x01

*THIS PAGE WAS
INTENTIONALLY
LEFT BLANK*

3. Message Protocol Details

The following sub-sections describe in detail the 17 supported messages.

3.1. Query for MAC ID

Master controller will use this message to query the existence of a MFC controller.

Query message from Master controller to a digital MFC controller

MAC ID (Targeted MFC controller address)
STX(0x02)
Command Code(0x80 for read)
Packet Length(0x03)
Class ID(0x03)
Instance ID(0x01)
Attribute ID(0x01)
Pad(0x00)
Checksum

Brooks RS485 L-Protocol MFCs

Response message from a digital MFC controller to Master controller

MAC ID (0 – Master controller)
STX(0x02)
Command Code(0x80 for read)
Packet Length(0x04)
Class ID(0x03)
Instance ID(0x01)
Attribute ID(0x01)
MFC MAC ID
Pad(0x00)
Checksum

3.2. Digital Mode Selection

Master controller will use this message to set a MFC controller to digital or analog mode.

MAC ID (Targeted MFC controller address)
STX(0x02)
Command Code(0x81 for write)
Packet Length(0x04)
Class ID(0x69)
Instance ID(0x01)
Attribute ID(0x03)
Mode(1 – digital, 2 - analog)
Pad(0x00)
Checksum

3.3. Query Present Control Mode

Master controller will use this message to query the present control mode.

MAC ID (Targeted MFC controller address)
STX(0x02)
Command Code(0x80 for read)
Packet Length(0x03)
Class ID(0x69)
Instance ID(0x01)
Attribute ID(0x03)
Pad(0x00)
Checksum

Response message from a digital MFC controller to Master controller

MAC ID (Targeted MFC controller address)
STX(0x02)
Command Code(0x80 for read)
Packet Length(0x04)
Class ID(0x69)
Instance ID(0x01)
Attribute ID(0x04)
Mode(1 – digital, 2 - analog)
Pad(0x00)
Checksum

Brooks RS485 L-Protocol MFCs

3.4. Freeze Follow

Master controller will use this message to configure a MFC controller to act upon a new set point when received.

MAC ID (Targeted MFC controller address)
STX(0x02)
Command Code(0x81 for write)
Packet Length(0x04)
Class ID(0x69)
Instance ID(0x01)
Attribute ID(0x05)
FreezeFollow(1-Act on new set point immediately)
Pad(0x00)
Checksum

3.5. New Setpoint

Master controller will use this message to send a new set point to a MFC controller.

MAC ID (Targeted MFC controller address)
STX(0x02)
Command Code(0x81 for write)
Packet Length(0x05)
Class ID(0x69)
Instance ID(0x01)
Attribute ID(0xA4)
Data Byte#1(LSB)
Data Byte#2(MSB)
Pad(0x00)
Checksum

Brooks RS485 L-Protocol MFCs

3.6. Ramp Time

Master controller will use this message to send a ramp time to a MFC controller. The ramp time is how long the MFC controller should take to reach the final set point from the current set point. The unit is millisecond. A zero ramp time effectively disables the ramping.

Request message from Master controller to a digital MFC controller

MAC ID (Targeted MFC controller address)
STX(0x02)
Command Code(0x81 for write)
Packet Length(0x05)
Class ID(0x6A)
Instance ID(0x01)
Attribute ID(0xA4)
Data Byte#1(LSB)
Data Byte#2(MSB)
Pad(0x00)
Checksum

3.7. Filtered Setpoint

Master controller will use this message to get the current set point from a MFC controller. This is the current set point after ramping has been applied.

Request message from Master controller to a digital MFC controller

MAC ID (Targeted MFC controller address)
STX(0x02)
Command Code(0x80 for read)
Packet Length(0x03)
Class ID(0x6A)
Instance ID(0x01)
Attribute ID(0xA6)
Pad(0x00)
Checksum

Brooks RS485 L-Protocol MFCs

Response message from a digital MFC controller to Master controller

MAC ID (0 – Master controller)
STX(0x02)
Command Code(0x80 for read)
Packet Length(0x05)
Class ID(0x6A)
Instance ID(0x01)
Attribute ID(0xA6)
Data Byte #1(LSB)
Data Byte #2(MSB)
Pad(0x00)
Checksum

3.8. Indicated Flow

Master controller will use this message to get the current flow reading from a MFC controller.

Request message from Master controller to a digital MFC controller

MAC ID (Targeted MFC controller address)
STX(0x02)
Command Code(0x80 for read)
Packet Length(0x03)
Class ID(0x6A)
Instance ID(0x01)
Attribute ID(0xA9)
Pad(0x00)
Checksum

Brooks RS485 L-Protocol MFCs

Response message from a digital MFC controller to Master controller

MAC ID (0 – Master controller)
STX(0x02)
Command Code(0x80 for read)
Packet Length(0x05)
Class ID(0x6A)
Instance ID(0x01)
Attribute ID(0xA9)
Data Byte #1(LSB)
Data Byte #2(MSB)
Pad(0x00)
Checksum

3.9. Valve Drive Current

Master controller will use this message to get the valve drive current.

Request message from Master controller to a digital MFC controller

MAC ID (Targeted MFC controller address)
STX(0x02)
Command Code(0x80 for read)
Packet Length(0x03)
Class ID(0x6A)
Instance ID(0x01)
Attribute ID(0xB6)
Pad(0x00)
Checksum

Brooks RS485 L-Protocol MFCs

Response message from a digital MFC controller to Master controller

MAC ID (0 – Master controller)
STX(0x02)
Command Code(0x80 for read)
Packet Length(0x05)
Class ID(0x6A)
Instance ID(0x01)
Attribute ID(0xB6)
Data Byte #1(LSB)
Data Byte #2(MSB)
Pad(0x00)
Checksum

3.10. Calibration Instance (Process Gas) Selection

Master controller will use this message to select which calibration instance is to be used for flow metering.

MAC ID (Targeted MFC controller address)
STX(0x02)
Command Code(0x81 for write)
Packet Length(0x04)
Class ID(0x66)
Instance ID(0x00)
Attribute ID(0x65)
Calibration Instance ID(#)
Pad(0x00)
Checksum

Brooks RS485 L-Protocol MFCs

3.11. Query for Calibration Instance (Process Gas) Selection

Master controller will use this message to query the selected calibration instance, which is currently being used for flow metering.

Request message from Master controller to a digital MFC controller

MAC ID (Targeted MFC controller address)
STX(0x02)
Command Code(0x80 for read)
Packet Length(0x03)
Class ID(0x66)
Instance ID(0x00)
Attribute ID(0x65)
Pad(0x00)
Checksum

Response message from a digital MFC controller to Master controller

MAC ID (0 – Master controller)
STX(0x02)
Command Code(0x80 for read)
Packet Length(0x04)
Class ID(0x66)
Instance ID(0x00)
Attribute ID(0x65)
Calibration Instance ID(#)
Pad(0x00)
Checksum

Brooks RS485 L-Protocol MFCs

3.12. Query for Available Calibration Instances (Process Gases)

Master controller will use this message to query available number of calibration instances.

Request message from Master controller to a digital MFC controller

MAC ID (Targeted MFC controller address)
STX(0x02)
Command Code(0x80 for read)
Packet Length(0x03)
Class ID(0x66)
Instance ID(0x00)
Attribute ID(0xA0)
Pad(0x00)
Checksum

Response message from a digital MFC controller to Master controller

MAC ID (0 – Master controller)
STX(0x02)
Command Code(0x80 for read)
Packet Length(0x04)
Class ID(0x66)
Instance ID(0x00)
Attribute ID(0xA0)
Available # Of Calibration Instances
Pad(0x00)
Checksum

Brooks RS485 L-Protocol MFCs

3.13. Auto Zero Enable/Disable

Master controller will use this message to enable auto zero function.

MAC ID (Targeted MFC controller address)
STX(0x02)
Command Code(0x81 for write)
Packet Length(0x04)
Class ID(0x68)
Instance ID(0x01)
Attribute ID(0xA5)
>0 for enable, = 0 for disable
Pad(0x00)
Checksum

3.14. Requested Zero Enable

Master controller will use this message to enable requested function.

MAC ID (Targeted MFC controller address)
STX(0x02)
Command Code(0x81 for write)
Packet Length(0x04)
Class ID(0x68)
Instance ID(0x01)
Attribute ID(0xBA)
1 for enable
Pad(0x00)
Checksum

Brooks RS485 L-Protocol MFCs

3.15. Query for Requested Zero Status

Master controller will use this message to query if the requested zero function has been completed.

Request message from Master controller to a digital MFC controller

MAC ID (Targeted MFC controller address)
STX(0x02)
Command Code(0x80 for read)
Packet Length(0x03)
Class ID(0x68)
Instance ID(0x01)
Attribute ID(0xBA)
Pad(0x00)
Checksum

Response message from a digital MFC controller to Master controller

MAC ID (0 – Master controller)
STX(0x02)
Command Code(0x80 for read)
Packet Length(0x04)
Class ID(0x68)
Instance ID(0x01)
Attribute ID(0xBA)
0: completed, 1: in progress
Pad(0x00)
Checksum

Brooks RS485 L-Protocol MFCs

3.16. Query for Sensor Current Zero

Master controller will use this message to query the current sensor zero offset.

Request message from Master controller to a digital MFC controller

MAC ID (Targeted MFC controller address)
STX(0x02)
Command Code(0x80 for read)
Packet Length(0x03)
Class ID(0x68)
Instance ID(0x01)
Attribute ID(0xA9)
Pad(0x00)
Checksum

Response message from a digital MFC controller to Master controller

MAC ID (0 – Master controller)
STX(0x02)
Command Code(0x80 for read)
Packet Length(0x05)
Class ID(0x68)
Instance ID(0x01)
Attribute ID(0xA9)
Data Byte #1(LSB)
Data Byte #2(MSB)
Pad(0x00)
Checksum

Brooks RS485 L-Protocol MFCs

3.17. Query for Sensor Reference Zero

Master controller will use this message to query the sensor reference zero offset.

Request message from Master controller to a digital MFC controller

MAC ID (Targeted MFC controller address)
STX(0x02)
Command Code(0x80 for read)
Packet Length(0x03)
Class ID(0x68)
Instance ID(0x01)
Attribute ID(0xAA)
Pad(0x00)
Checksum

Response message from a digital MPC controller to Master controller

MAC ID (0 – Mastercontroller)
STX(0x02)
Command Code(0x80 for read)
Packet Length(0x05)
Class ID(0x68)
Instance ID(0x01)
Attribute ID(0xAA)
Data Byte #1(LSB)
Data Byte #2(MSB)
Pad(0x00)
Checksum

Brooks RS485 L-Protocol MFCs

3.18. Set Sensor Reference Zero

Master controller will use this message to set sensor reference zero offset.

MAC ID (Targeted MFC controller address)
STX(0x02)
Command Code(0x81 for write)
Packet Length(0x05)
Class ID(0x68)
Instance ID(0x01)
Attribute ID(0xAA)
Data Byte#1(LSB)
Data Byte#2(MSB)
Pad(0x00)
Checksum

3.19. Set Default Control Mode

Master controller will use this message to set MFC control mode when first powered up.

MAC ID (Targeted MFC controller address)
STX(0x02)
Command Code(0x81 for write)
Packet Length(0x04)
Class ID(0x69)
Instance ID(0x01)
Attribute ID(0x04)
Mode(1 – digital, 2 - analog)
Pad(0x00)
Checksum

Brooks RS485 L-Protocol MFCs

3.20. Query Default Control Mode

Master controller will use this message to query the MFC wakeup control mode.

MAC ID (Targeted MFC controller address)
STX(0x02)
Command Code(0x80 for read)
Packet Length(0x03)
Class ID(0x69)
Instance ID(0x01)
Attribute ID(0x04)
Pad(0x00)
Checksum

Response message from a digital MFC controller to Master controller

MAC ID (Targeted MFC controller address)
STX(0x02)
Command Code(0x80 for read)
Packet Length(0x04)
Class ID(0x69)
Instance ID(0x01)
Attribute ID(0x04)
Mode(1 – digital, 2 - analog)
Pad(0x00)
Checksum

*THIS PAGE WAS
INTENTIONALLY
LEFT BLANK*

4. Software Design Requirement

4.1. Normal Transaction Scenarios

4.1.1. Read Transaction Scenario

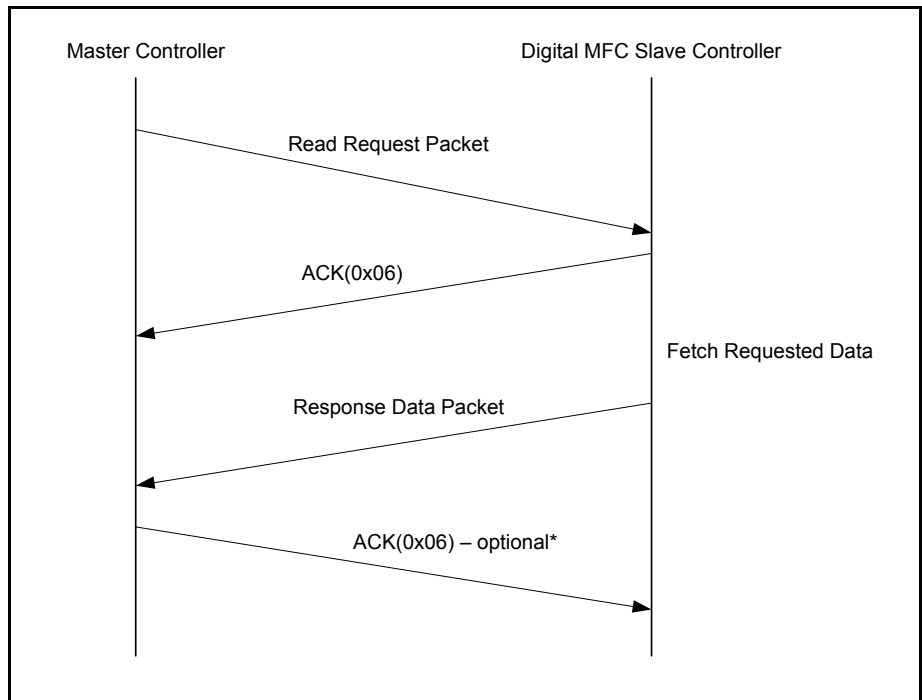

* If the slave controller does not receive any response within a reasonable time (18-20 character times) after sending a message, it behaves as though it received an ACK. If the slave controller receives an invalid response, it behaves as though it received an ACK, and assumes that the invalid character is the target address for a new message.

Brooks RS485 L-Protocol MFCs

4.1.2. Write Transaction Scenario

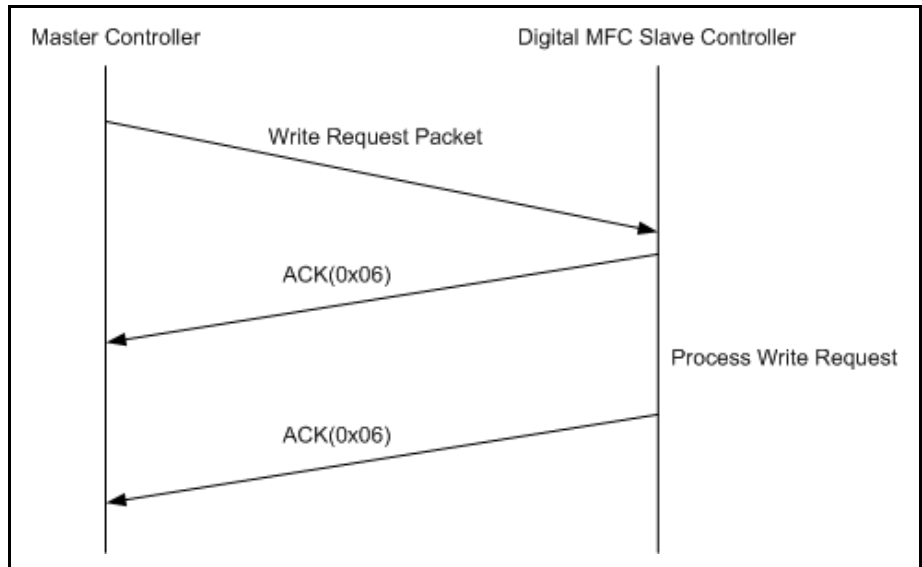

4.2. Abnormal Transaction Scenarios

4.2.1. Read Transaction Scenario

There are two different types of abnormal read transaction scenarios: packet error or read error within the MFC controller.

4.2.1.1. Packet Error

If the Class, Instance, Attribute ID, or checksum is invalid in the Read Request Packet, the digital MFC controller responds with a NAK(0x16) character.

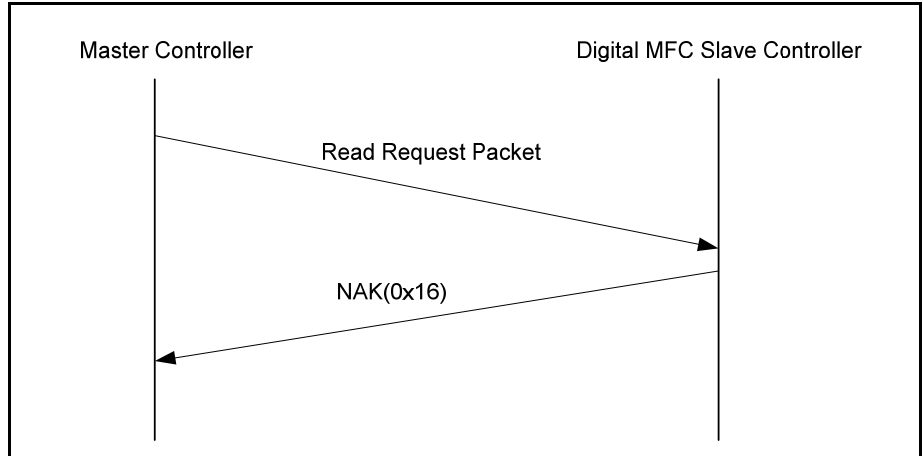

4.2.1.2. Read Error

If any errors occur within the MFC controller after the first ACK is sent (no packet errors), a NAK (0x16) will be sent to indicate an execution error.

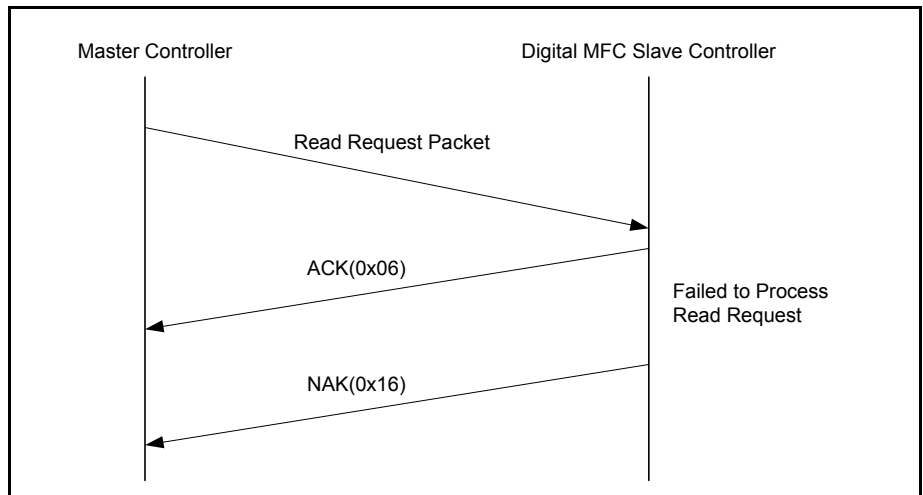

Brooks RS485 L-Protocol MFCs

4.2.2. Write Transaction Scenario

There are two different types of abnormal write transaction scenarios: packet error or write error within the MFC controller.

4.2.2.1. Packet Error

If the Class, Instance, Attribute ID, or checksum is invalid in the Read Request Packet, the digital MFC controller responds with a NAK(0x16) character.

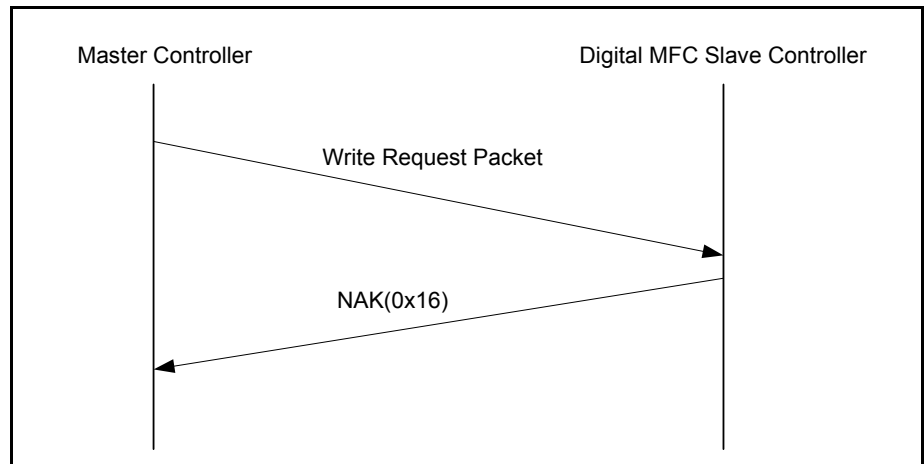

4.2.2.2. Write Error

If any errors occur within the MFC controller after the first ACK is sent (no packet errors), a NAK (0x16) will be sent to indicate an execution error.

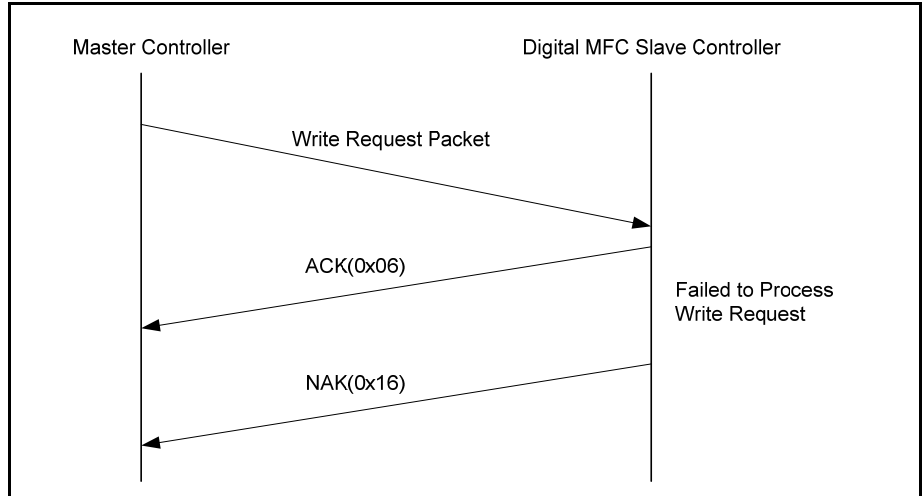

4.3. Protocol Timing

Devices on the RS485 bus distinguish address characters from other packet characters by maintaining an idle timer. This timer is started at the end of each received character, and expires if the next character does not arrive within two bytes times (20 bit times). If the timer expires, the device assumes that the message has ended, and the next character received will be either a target address, or a response indicating the acceptance of the previous packet (ACK or NAK). **Thus it is vital that devices on the bus not insert idle gaps of 1 character time or more within a packet.** A target device can also assume that an error has occurred if a new character is expected and does not arrive within 2 character times of the preceding character's arrival.

Each transaction on the bus begins when the Master controller transmits a request packet on the bus, following an idle gap of at least 1 character time. The specified slave MFC controller replies quickly with an ACK character (0x06) to indicate that it has received the packet correctly. After the request message is processed, the specified controller responds with a reply message or an ACK.

Since the current supported messages are simple and small, the Master controller expects that the entire response to the request message to be completed by the MFC controller within 5 ms. If the Master controller does not receive all response characters (ACK+ACK (2 bytes) for write request, ACK + response packet (11 or 12 bytes)) within 5ms, it assumes that an error has occurred and up to 3 retries are performed automatically.

Brooks RS485 L-Protocol MFCs

4.4. Message Sequence between Master Controller and a MFC Slave Controller

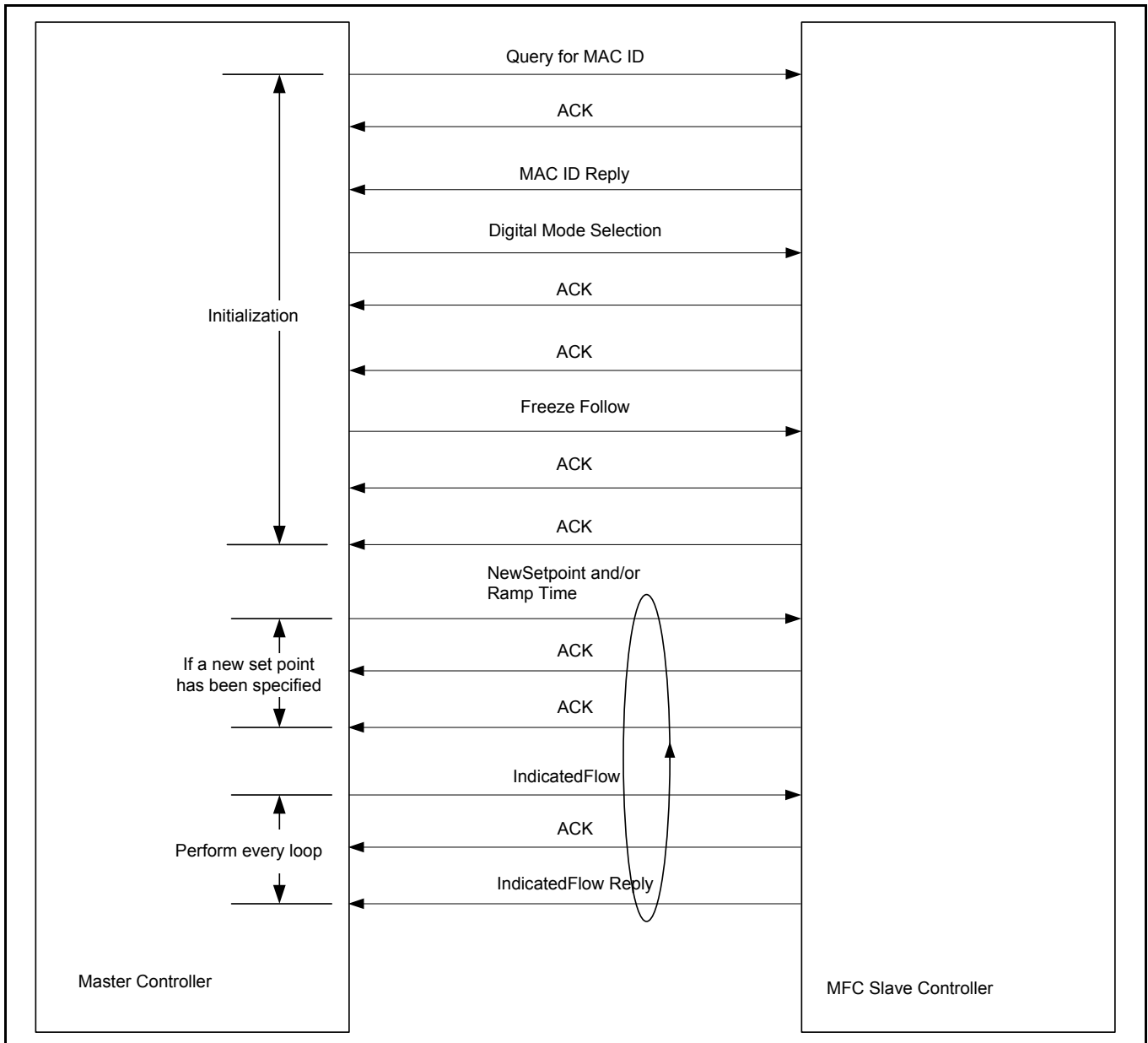

4.5. MFC New Setpoint Conversion

The NewSetpoint request takes values in the range of 0x4000 to 0xC000 which represent set points between 0% and 100% full scale. The linear relationship between Full Scale set points and NewSetpoint is demonstrated in the following table:

Full Scale % set point	NewSetpoint Valve(Hex)
0.0	4000
25.0	6000
50.0	8000
75.0	A000
99.0	BEB8
100.0	C000

The “NewSetpoint” value may be calculated from the full scale percent value by:

$$\text{“NewSetpoint”} = (327.68 * \text{full scale \%}) + 16,384$$

or

$$\text{“NewSetpoint”} = ((0xC000-0x4000)/100 * \text{full scale \%}) + 0x4000$$

Note that at the communication level all values are sent in binary format. The decimal and hexadecimal formats shown above are for convenience.

4.6. Sensor Zero Filter

The digital MFC controller should provide sensor zero filter to support correction for reasonably stable offsets in the gas flow sensor. The actual flow reading (IndicatedFlow) should be derived by subtracting **SensorCurrentZero** from each sensor measurement. **SensorCurrentZero** can be updated under two conditions, described in the following sub-sections.

Brooks RS485 L-Protocol MFCs

4.6.1. Requested Zero

When the requested zero command is issued by Master controller, the digital MFC controller should close the flow meter valve and wait until the sensor output is stabilized (typically 90 seconds). Then the requested zero function can be started and the **SensorCurrentZero** is to be updated through the entire process. At the end of the process, **SensorReferenceZero** is to be set to **SensorCurrentZero**. If Auto Zero function is never enabled, the **SensorCurrentZero** is always equal to **SensorReferenceZero**. For flexibility the **SensorReferenceZero** can also be set by the Master controller.

Due to the long duration to execute the "Enable requested Zero" command, the MFC will not return an ACK when process is completed. Instead, an ACK is sent to acknowledge start of execution. During the process time, the MFC is in an "In Progress" state. While in the "In Progress" state, the MFC will only accept commands from the "Query Requested Zero Status" command, all other request to the MFC can be ignored

4.6.2. Auto Zero

Auto zero process can be started under the following condition:

- Auto Zero Enable has been issued by Master controller
- The digital MFC is in OFF mode

Once the above condition has been true for a specified delay (typically 90 seconds), auto zero process can be started at the specified rate (typically 10 times per second) and the **SensorCurrentZero** is to be updated through the entire process.

During the auto zero calculations, the digital MFC controller can use **SensorReferenceZero** to check against the calculated results. If the difference between **SensorReferenceZero** and the calculated result is beyond a specified limit, exception can be raised within the digital MFC controller.

4.7. Calibration Instances

Each calibration instance contains values needed by flow meter to calculate the actual gas flow rate for a particular process gas and flow range from sensor readings. This protocol allows Master controller to query for number of available calibration instances supported by the digital MFC controller and select a calibration instance for digital MFC operation and calculation. The detailed calibration instance internal setup is not supported through this interface and must be programmed through local MFC controller.

4.8. Analog / Digital Mode

The default mode for the MFC is set to Analog Mode. MFC's can be switch to Digital Mode with the "Digital Mode Selection" command as soon as communication is established

*THIS PAGE WAS
INTENTIONALLY
LEFT BLANK*

5. Advanced Diagnostics (GF135 Only)

5.1. New Communication Protocol Overview

5.1.1. Objectives and Problem Statement

Through the years, issues found in the field on Brooks MFCs have been very difficult to troubleshoot due to lack of information given to failure analysis teams. Issues that are random in occurrence and are specific to the field setup are the most difficult to reproduce therefore troubleshooting takes longer.

This new communication capability will enable the device to perform a series of self validation at regular interval and report its status to the tool software. Some of the self validation will require at least knowing the state of certain part of the tool over which the device typically had neither control nor access. The capabilities of the GF135 will enable short interval control of the upstream isolation valve in a manner consistent with good safety practices.

Those capabilities do not exist in any protocol currently in use in the field.

5.1.2. Protocol Description

The communication protocol shall be implemented over RS485 physical layer.

The protocol shall be able to handle the following type of communications between the device and the tool:

- Tool request for Commissioning status
- Tool request for valve leak status, ROD measurements

These are the minimum requirements to support advanced diagnostics.

Brooks RS485 L-Protocol MFCs

5.2. Specific Requirements

5.2.1. Introduction

The following requirements are a subset of Brooks' new communication protocol definition.

5.2.2. Advanced Protocol

The advanced communication protocol is more fully defined in GF135-SRS-011.

5.2.3. New Attributes

Note: Those attributes are valid as of the date of writing. Attribute ID are subject to change and new attributes will likely be added by the time this document is finalized.

New attributes for the advanced diagnostic:

Attribute	Access	Class	Instance	Att. ID	Values
isolation valve status	READ ONLY	177	1	3	0: Upstream open 1: Upstream closed
ROD delay	Read/Write	177	1	20	Delay before first ROD measurement after a setpoint change (seconds). Minimum = default = 4 sec.
ROD interval	Read/Write	177	1	21	Interval between ROD measurement when setpoint is constant (seconds). Minimum = 5 sec. Default = 10 sec.
ROD enable Default flag	Read/Write	177	1	55	0: ROD is disabled 1: ROD is enabled Non Volatile. Copied to Attribute 62 at power up. Default = Enabled

Attribute	Access	Class	Instance	Att. ID	Values
ROD Error Status	READ ONLY	177	1	56	0: ROD Error (attribute 11) is not valid 1: ROD Error (attribute 11) is valid
Valve Leak status	READ ONLY	177	1	57	0: Valve Leak Meas. is not valid 1: Valve Leak Meas. is valid
Valve Leak value	READ ONLY	177	1	59	Float, fraction of configured range
ROD Current Setpoint	READ ONLY	177	1	60	Current setpoint at which the ROD is being measured (see attribute 11) (fraction of configured range)
ROD error	READ ONLY	177	1	61	ROD measured flow change (from baseline) in % SP for the current setpoint. Same as ROD error N.
ROD enable flag	Read/Write	177	1	62	0: ROD is disabled 1: ROD is enabled Volatile
Commissioning status	Read/Write	103	n	132	0: Not done or failed 1: Commissioning was successful
ROD 0 Status	READ ONLY	177	1	70	0: ROD Error 0 is not valid 1: ROD Error 0 is valid
ROD 1 Status	READ ONLY	177	1	71	0: ROD Error 1 is not valid 1: ROD Error 1 is valid
ROD 2 Status	READ ONLY	177	1	72	0: ROD Error 2 is not valid 1: ROD Error 2 is valid
ROD 3 Status	READ ONLY	177	1	73	0: ROD Error 3 is not valid 1: ROD Error 3 is valid
ROD 4 Status	READ ONLY	177	1	74	0: ROD Error 4 is not valid 1: ROD Error 4 is valid
ROD 5 Status	READ ONLY	177	1	75	0: ROD Error 5 is not valid 1: ROD Error 5 is valid
ROD 6 Status	READ ONLY	177	1	76	0: ROD Error 6 is not valid 1: ROD Error 6 is valid
ROD 7 Status	READ ONLY	177	1	77	0: ROD Error 7 is not valid 1: ROD Error 7 is valid
ROD 8 Status	READ ONLY	177	1	78	0: ROD Error 8 is not valid 1: ROD Error 8 is valid
ROD 9 Status	READ ONLY	177	1	79	0: ROD Error 9 is not valid 1: ROD Error 9 is valid
ROD 10 Status	READ ONLY	177	1	80	0: ROD Error 10 is not valid 1: ROD Error 10 is valid

Brooks RS485 L-Protocol MFCs

Attribute	Access	Class	Instance	Att. ID	Values
ROD 11 Status	READ ONLY	177	1	81	0: ROD Error 11 is not valid 1: ROD Error 11 is valid
ROD 12 Status	READ ONLY	177	1	82	0: ROD Error12 is not valid 1: ROD Error 12 is valid
ROD 13 Status	READ ONLY	177	1	83	0: ROD Error 13 is not valid 1: ROD Error 13 is valid
ROD 14 Status	READ ONLY	177	1	84	0: ROD Error 14 is not valid 1: ROD Error 14 is valid
ROD 15 Status	READ ONLY	177	1	85	0: ROD Error 15 is not valid 1: ROD Error 15 is valid
ROD 16 Status	READ ONLY	177	1	86	0: ROD Error 16 is not valid 1: ROD Error 16 is valid
ROD 17 Status	READ ONLY	177	1	87	0: ROD Error 17 is not valid 1: ROD Error 17 is valid
ROD 18 Status	READ ONLY	177	1	88	0: ROD Error 18 is not valid 1: ROD Error 18 is valid
ROD 19 Status	READ ONLY	177	1	89	0: ROD Error 19 is not valid 1: ROD Error 19 is valid
ROD Error 0	READ ONLY	177	1	90	Float, Avg. error for setpoint 0-5%
ROD Error 1	READ ONLY	177	1	91	Float, Avg. error for setpoint 5-10%
ROD Error 2	READ ONLY	177	1	92	Float, Avg. error for setpoint 10-15%
ROD Error 3	READ ONLY	177	1	93	Float, Avg. error for setpoint 15-20%
ROD Error 4	READ ONLY	177	1	94	Float, Avg. error for setpoint 20-25%
ROD Error 5	READ ONLY	177	1	95	Float, Avg. error for setpoint 25-30%
ROD Error 6	READ ONLY	177	1	96	Float, Avg. error for setpoint 30-35%
ROD Error 7	READ ONLY	177	1	97	Float, Avg. error for setpoint 35-40%
ROD Error 8	READ ONLY	177	1	98	Float, Avg. error for setpoint 40-45%
ROD Error 9	READ ONLY	177	1	99	Float, Avg. error for setpoint 45-50%
ROD Error 10	READ ONLY	177	1	100	Float, Avg. error for setpoint 50-55%
ROD Error 11	READ ONLY	177	1	101	Float, Avg. error for setpoint 55-60%
ROD Error 12	READ ONLY	177	1	102	Float, Avg. error for setpoint 60-65%
ROD Error 13	READ ONLY	177	1	103	Float, Avg. error for setpoint 65-70%
ROD Error 14	READ ONLY	177	1	104	Float, Avg. error for setpoint 70-75%
ROD Error 15	READ ONLY	177	1	105	Float, Avg. error for setpoint 75-80%
ROD Error 16	READ ONLY	177	1	106	Float, Avg. error for setpoint 80-85%

Attribute	Access	Class	Instance	Att. ID	Values
ROD Error 17	READ ONLY	177	1	107	Float, Avg. error for setpoint 85-90%
ROD Error 18	READ ONLY	177	1	108	Float, Avg. error for setpoint 90-95%
ROD Error 19	READ ONLY	177	1	109	Float, Avg. error for setpoint 95-100%

The following set of attributes is required for the data logging and trending:

Attribute	Access	Class	Instance	Att. ID	Values
Time Synchronization	WRITE ONLY	0x43 (67)	1	TBD	Time and date information Not implemented
Data Request	READ ONLY	0x41 (65)	1	TBD	Trending information Not implemented

5.3. Tool – Device Communication

The following items need to be addressed with the customer to define the new advanced diagnostic protocol:

Tool to provide status (e.g. isolation valve status upstream and downstream)

Some operations require knowing the status of the isolation valves on both sides of the device. The tool shall provide this information by writing to the isolation valve status attribute whenever the status changes.

Note: At this time, this is not implemented on the customer tool software.

Request from the device to the tool to modify the tool status (e.g. Operating the isolation valves at the request of the MFC)

Some operations require a specific state of the isolation valves on both sides of the device. The tool shall read the isolation valve request attribute on a schedule TBD and satisfy the request of the MFC.

Note: At this time, this is not implemented on the customer tool software.

Brooks RS485 L-Protocol MFCs

Time synchronization

In order to provide accurate data logging for the trending diagnostic, the tool will need to provide accurate time synchronization. The MFC is capable of running a real time clock, so only occasional synchronization is required (at least once per power on cycle)

Note: At this time, this is not implemented on the customer tool software.

Request from the tool for some trending information

Data can be logged at regular interval and time stamped using the time information

Data can be retrieved by the customer to provide long term trend (e.g. zero information logged once per week)

Note: At this time, this is only supported via the diagnostic port.

6. Appendix: Tool - Device Communication

MFC's can have software configurable MAC ID's by sending the "Set MAC ID" command to the current MFC controller address or the default address (0xFF).

Master controller will use this message to set the MAC ID of a MFC.

Set message from Master controller to a digital MFC controller

MAC ID (Targeted MFC controller address)
STX(0x02)
Command Code(0x81 for write)
Packet Length(0x04)
Class ID(0x03)
Instance ID(0x01)
Attribute ID(0x01)
Data(0x33~0x47)
Pad(0x00)
Checksum

Brooks RS485 L-Protocol MFCs

*THIS PAGE WAS
INTENTIONALLY
LEFT BLANK*

Installation and Operation Manual

X-DPT-RS485-GF100-Series-MFC-eng

Part Number: 541B183AAG

March, 2013

Brooks RS485 L-Protocol MFCs

*THIS PAGE WAS
INTENTIONALLY
LEFT BLANK*

Brooks RS485 L-Protocol MFCs

LIMITED WARRANTY

Seller warrants that the Goods manufactured by Seller will be free from defects in materials or workmanship under normal use and service and that the Software will execute the programming instructions provided by Seller until the expiration of the earlier of twelve (12) months from the date of initial installation or eighteen (18) months from the date of shipment by Seller. Products purchased by Seller from a third party for resale to Buyer ("Resale Products") shall carry only the warranty extended by the original manufacturer.

All replacements or repairs necessitated by inadequate preventive maintenance, or by normal wear and usage, or by fault of Buyer, or by unsuitable power sources or by attack or deterioration under unsuitable environmental conditions, or by abuse, accident, alteration, misuse, improper installation, modification, repair, storage or handling, or any other cause not the fault of Seller are not covered by this limited warranty, and shall be at Buyer's expense.

Goods repaired and parts replaced during the warranty period shall be in warranty for the remainder of the original warranty period or ninety (90) days, whichever is longer. This limited warranty is the only warranty made by Seller and can be amended only in a writing signed by an authorized representative of Seller.

BROOKS SERVICE AND SUPPORT

Brooks is committed to assuring all of our customers receive the ideal flow solution for their application, along with outstanding service and support to back it up. We operate first class repair facilities located around the world to provide rapid response and support. Each location utilizes primary standard calibration equipment to ensure accuracy and reliability for repairs and recalibration and is certified by our local Weights and Measures Authorities and traceable to the relevant International Standards.

Visit www.BrooksInstrument.com to locate the service location nearest to you.

START-UP SERVICE AND IN-SITU CALIBRATION

Brooks Instrument can provide start-up service prior to operation when required.

For some process applications, where ISO-9001 Quality Certification is important, it is mandatory to verify and/or (re)calibrate the products periodically. In many cases this service can be provided under in-situ conditions, and the results will be traceable to the relevant international quality standards.







CUSTOMER SEMINARS AND TRAINING

Brooks Instrument can provide customer seminars and dedicated training to engineers, end users and maintenance persons.

Please contact your nearest sales representative for more details.

HELP DESK

In case you need technical assistance:

USA		888 275 8946	Korea		+82 31 708 2521
Netherlands		+31 (0) 318 549290	Taiwan		+886 3 5590 988
Germany		+49 351 215 2040	China		+86 21 5079 8828
Japan		+81 3 5633 7100	Singapore		+6297 9741



Due to Brooks Instrument's commitment to continuous improvement of our products, all specifications are subject to change without notice.

TRADEMARKS

Brooks .
DeviceNet

Brooks Instrument, LLC
Open DeviceNet Vendors Association, Inc.

Brooks Instrument
407 West Vine Street
P.O. Box 903
Hatfield, PA 19440-0903 USA
T (215) 362 3700
F (215) 362 3745
E-Mail BrooksAm@BrooksInstrument.com
www.BrooksInstrument.com

Brooks Instrument
Neonstraat 3
6718 WX Ede, Netherlands
T +31 (0) 318 549 300
F +31 (0) 318 549 309
E-Mail BrooksEu@BrooksInstrument.com

Brooks Instrument
1-4-4 Kitasuna Koto-Ku
Tokyo, 136-0073 Japan
T +81 (0) 3 5633 7100
F +81 (0) 3 5633 7101
E-Mail BrooksAs@BrooksInstrument.com

BROOKS[®]
INSTRUMENT

GF Series

GF100/GF120/GF125

Thermal Mass Flow



GF100 Series

High Purity/Ultra-High Purity Digital Thermal Mass Flow Devices

Overview

Designed for semiconductor, MOCVD, and other gas flow control applications that require a high purity all-metal flow path, the Brooks® GF100 Series mass flow controllers and meters deliver outstanding performance, reliability, and flexibility. Highlights of the GF Series industry-leading features include: ultra fast 300 millisecond settling time, MultiFlo™ gas and range programmability, optional pressure transient insensitivity (PTI), local display, extremely low wetted surface area, and corrosion resistant Hastelloy® sensor tube and valve seat. The GF100 Series has been marathon tested to over three times the semiconductor industry standard for reliability, ensuring repeatable low-drift performance over time. An independent diagnostic/service port permits users to troubleshoot or change flow conditions without removing the mass flow controller from service.

The flagship GF125 is a second generation multi-variable, pressure transient insensitive mass flow controller. This product builds upon Brooks' leadership position in pressure transient insensitive (PTI) mass flow controller technology, minimizing process gas flow variation due to pressure and temperature fluctuations. The GF125 enables customers to simplify and reduce the size and cost of gas panels by eliminating the need for point of use pressure regulators, pressure transducers, and associated hardware.

MultiFlo™ gas and range programmability, a patented technology developed and refined by Brooks over the last 10 years, has changed the mass flow controller industry by offering customers the ability to select new gas calibrations and full scale ranges without the trouble and cost of removing the mass flow controller from the gas line. The GF Series fourth generation MultiFlo technology continues to lead the market with the most accurate and broadest range performance through extensive refinement and physical validation on critical process gases.

Product Description

The GF100 Series is a highly configurable platform based on a novel modular architecture. Already widely adopted by semiconductor, vacuum thin film, solar, and related customers, the GF100 Series feature set was carefully selected to enable drop-in replacement and upgrade of most brands of metal-seal mass flow controllers, including the former Celerity, UNIT, Tylan, and Mykrolis brands. With the wide range of options and features available, the GF100 Series provides users with a path to simplification and standardization, greatly reducing spares inventory and support costs.

Features and Benefits

Convenient Service Port

- Easy diagnostics and troubleshooting
- Independent of tool communication

User Interface

- Easy installation, start-up, and operation

Magnetically Coupled Valve

- Corrosion resistant all metal valve
- Diaphragm free design, unaffected by differential pressure
- High purge rate capability
- Tested for over seven million cycles with no failures

Second Generation T-Rise Sensor

- Excellent long-term stability ($<\pm 0.5\%$ F.S./yr.)
- Improved signal to noise ratio
- High purge rate capability
- Lower temperature operation for gases prone to thermal decomposition

Temperature Sensor

- Accurate flow and temperature measurement over full temperature range
- Real-time compensation for ambient temperature fluctuations enable precise gas chemistry control

Pressure Sensor

- Stable flow control regardless of upsets or fluctuations in delivery pressure

Features	Benefits
MultiFlo Gas and Range Configurability	Ability to reconfigure the mass flow controller for new gas calibrations and full scale ranges without the time and costs of removing the device from the gas line.
User Accessible Service Port with Advanced Diagnostics with User-Friendly Interface	Convenient interface to diagnostics for maximum uptime. Ensures device is operating within user specified limits for high yield and maximum uptime.
Corrosion Resistant Hastelloy T-Rise Sensor	Provides unmatched long-term sensor stability ensuring maximum yield and throughput.
Pressure Transient Insensitivity (PTI), and Safe Delivery System (SDS) Options	Improves yield. Reduces overall gas panel costs.

Product Description

Ultra Fast Response

By combining Brooks' patented flow sensor technology with a high speed ARM processor and fast acting diaphragm free valve assembly, the GF100 Series delivers up to 3 times faster response and settling time compared to other mass flow controllers, enabling:

- Improved wafer throughput by reducing nonproductive flow settling steps
- Critical Etch processes requiring ultrafast 1-2 second etch steps
- Reduced diverted gas consumption and associated abatement costs
- Time-sensitive gas delivery steps in Atomic Layer Deposition
- For processes requiring a slow ramped gas turn-on or time critical transitions between flow rates. A user programmable ramp function is provided

MultiFlo™ Gas and Range Configurability

A major advancement over traditional single point gas conversion factors, Brooks MultiFlo technology delivers up to a three-times improvement in process gas accuracy. This is achieved through advanced gas modeling optimized through actual gas testing providing compensation for non-linear gases. MultiFlo also allows the device to be quickly and easily configured for another gas and/or flow range without sacrificing accuracy or rangability. Selecting a new gas automatically creates a new calibration curve, establishes optimized PID settings for dynamic control, automatically compensates for gas density effects, and ensures smooth, overshoot-free transitions between flow rates with excellent steady-state stability.

Brooks MultiFlo technology offers unparalleled flexibility; a single device can be programmed for thousands of different gas and flow range configurations.

Re-programming is simple and fast; a new gas and range can be programmed in under 30 seconds. Brooks provides a full gas database to ensure the true value of MultiFlo is realized:

- Dramatically reduces inventory costs
- Mass flow controller full scale flow range can re-scaled down typically by a factor of 3:1 with no impact on accuracy, turndown or leak by specifications, for optimum process and inventory flexibility
- Up to 40% fewer configurations required to support typical etch and CVD processes verses our closest competitor
- Widest process gas coverage through extensive gas library
- Mass flow controllers can be replaced in only a few minutes
- Off-the shelf spares programmability enables rapid process recovery
- Maximum flexibility for research applications

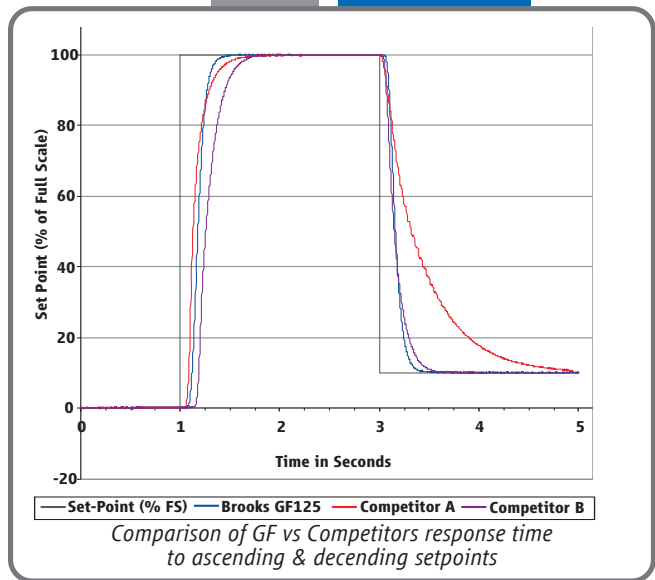

GF Series MFC

3.6L He 3.6L Ar 1.6L Xe 2.6L H2
 2.6L CO 2.1L HBr 2.6L N2 1.6L C12
 1.8L H2Se 2.0L NH3 1.9L PH3 1.7L COS
 1.5L SiH4 1.3L NF3 1.5L COF2 ...

MultiFlo™ technology allows one GF Series to be programmed for thousands of different gases and flow ranges

# of Platforms	GF1xx Series Range	Competitor A 2 Models Range	Competitor B 4 Models Range
1	3 - 10	10	1 - 5
2	11 - 30	17.5	6 - 14
3	31 - 92	30	15 - 27
4	93 - 280	55	28 - 38
5	281 - 860	100	39 - 71
6	861 - 2,600	175	72 - 103
7	2,601 - 7,200	300	104 - 192
8	7,201 - 15,000	550	193 - 279
9	15,001 - 30,000	1,000	280 - 754
10	30,001 - 40,000	1,750	755 - 2,037
11	40,001 - 55,000	3,000	2,038 - 5,500
12		5,500	5,501 - 11,000
13		10,000	11,001 - 30,000
14		22,000	30,001 - 50,000
15		30,000	
16		50,000	

The Brooks Advantage! Less platforms means more process flexibility and lower cost of spares.

Product Description

MultiFlo™ Configurator Accessory Kits:

778Z010ZZZ

Basic MultiFlo Configurator Kit

A331710003

*Software, MultiFlo Configurator

214F027AAA

Cable Assembly 2.5mm

778Z011ZZZ

Basic MultiFlo Configurator Kit w/Power Supply and Adapter Cables

A331710003

*Software, MultiFlo Configurator

214F027AAA

Cable Assembly 2.5mm

A332295001

USB-RS485 Converter with DB-9 female

A332297002

Power Supply MFC

A332297001

Cable, Power, 9-Pin

Cable, Power, DeviceNet

* MultiFlo Configurator Software is available on the Brooks Instrument website at: www.BrooksInstrument.com/MultiFlo

Pressure Transient Insensitivity (PTI) (GF125 only)

Cost and space constraints are driving gas panel designers to remove point of use pressure regulators and pressure monitoring components, placing more burden on the mass flow controller to control accurately under dynamic pressure conditions. Conventional mass flow controllers react strongly to small inlet pressure fluctuations resulting in unstable performance and unpredictable accuracy (see Non-Pressure Insensitive MFC). This drove Brooks to develop Pressure Transient Insensitive mass flow controller technology (PTI-MFC).

The GF125 PTI-MFC is a second generation PTI-MFC utilizing a patented control algorithm that inverts the pressure signal, compares it to the pre-fluctuation signal and drives real-time valve position compensation to maintain stable flow. Enhanced pressure transient insensitivity is achieved through faster sensing, faster processing, and a reduction in internal dead-volume between the sensors and valve orifice.

Advanced Thermal Flow Measurement Sensor

Brooks' proprietary sensor technology combines:

- Improved signal to noise performance for improved accuracy at low setpoints
- Improved reproducibility at elevated temperatures through new isothermal packaging, onboard conditioning electronics with ambient temperature sensing and compensation
- Improved long-term stability through enhanced sensor manufacturing and burn in process
- Highly corrosion resistant Hastelloy C-22 sensor tube
- Optimized temperature profile for gases prone to thermal decomposition
- Unique orthogonal sensor mounting orientation
 - Eliminates sensor drift caused by valve heating effects
 - Eliminates thermal siphoning effects for the most common mounting orientations

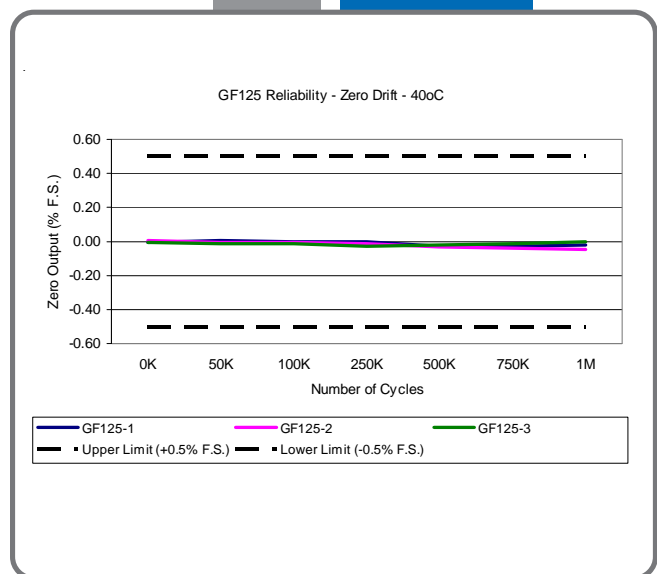
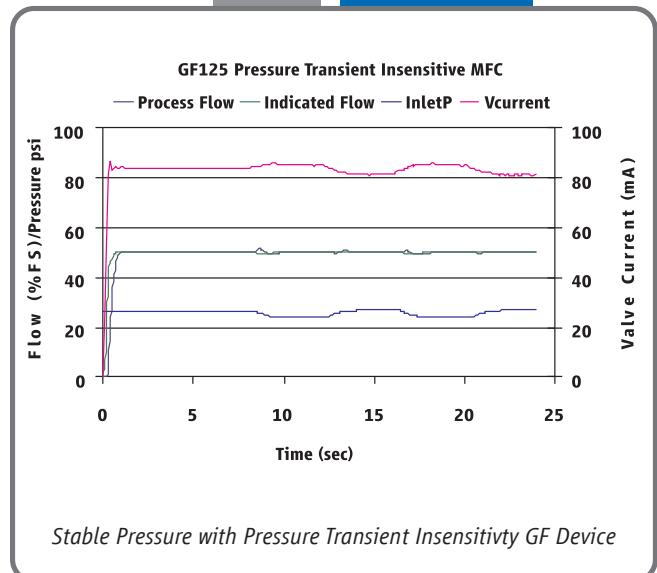
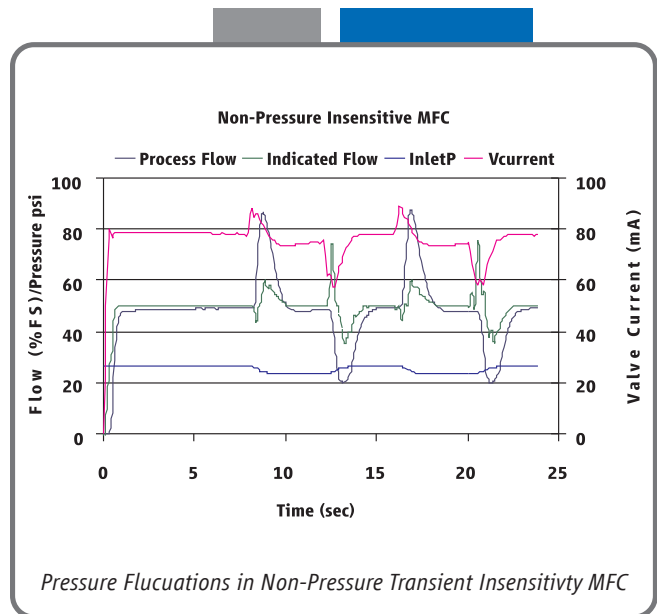

Product Description

High Purity Flow Path

All metal, corrosion resistant flow path with reduced surface area and un-swept volumes for faster dry-down during purge steps:

- SEMI F-20 compliant wetted flow path
- 4 μ inch Ra max surface finish standard (10 μ inch Ra on GF100)
- Highly corrosion resistant Hastelloy C-22 valve seat and jet orifice

Extensive Mechanical Configuration Support

GF100 Series supports all metal seal / UHP industry gas connection interface standards for full OEM and process coverage

- Downport 80mm and 92mm C-seal and W-Seal, on 1.125" and 1.5" bodies
- Downport 80mm CS seal on 1.5" body
- 124 mm 1/4" VCR Male on 1.5" body

Enhanced Diagnostics

The mass flow controller remains the most complex and critical component in gas delivery systems. When dealing with UHP gas distribution or highly toxic or corrosive gases, removing the mass flow controller to determine if it is faulty should be the last resort. In response to this, Brooks pioneered smarter mass flow controllers with embedded self test routines and introduced an independent diagnostic/service port to provide the user with a simple interface, for troubleshooting without disturbing flow controller operation.

User Interface

The user interface has a high visibility LCD display that provides a local indication of Flow (%), Temperature ($^{\circ}$ C), Pressure (PSIA/ KPa) and Network Address, selectable through the Display button. A Zero button provides a simple means to re-zero the mass flow controller as part of scheduled maintenance.

Communication Interface

The GF100 Series supports analog 0-5 Vdc, RS485, and DeviceNet™ communication protocols. A range of low profile adapter cables facilitate replacing older mass flow controllers with the GF100 Series eliminating the need to carry mass flow controllers of same gas/range but different electrical connectors.

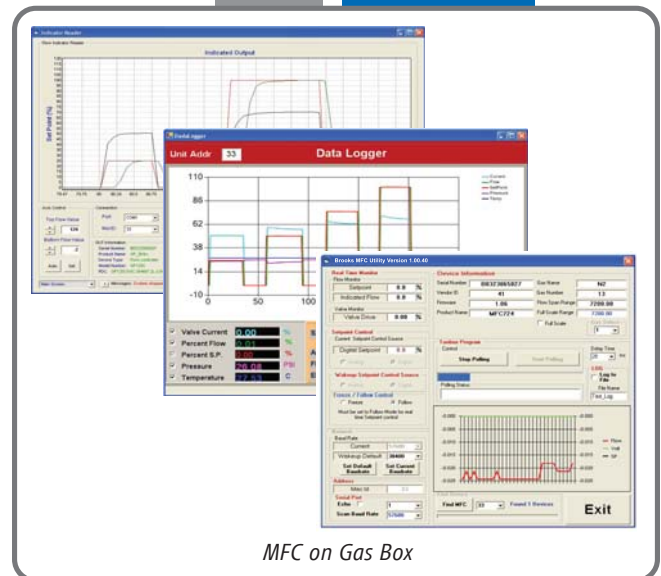
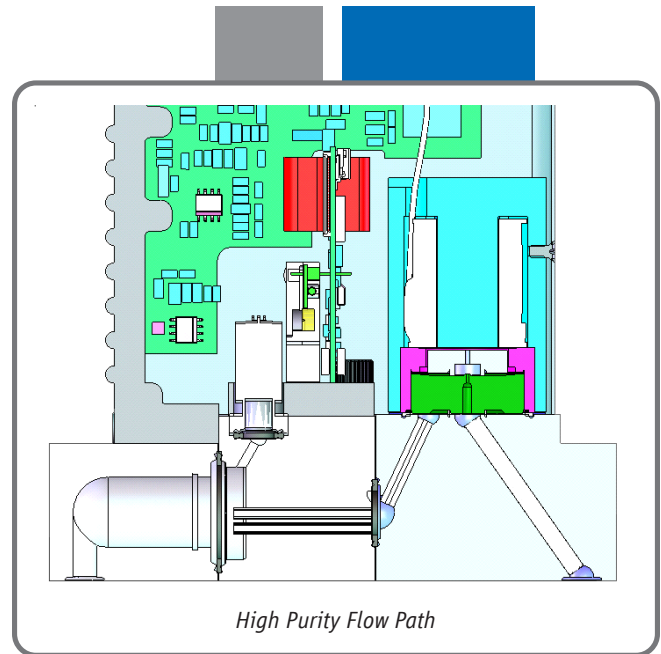

Product Specifications (Standard GF Series)

Performance	GF100	GF120	GF125
Full Scale Flow Range (N ₂ Eq.)	3 sccm to 55 slm		
Flow Accuracy	±1% S.P. > 35-100%, ±0.35% F.S. 2-35%		
Repeatability & Reproducibility	< ± 0.15% S.P.		
Linearity	± 0.5% F.S. (included in accuracy)		
Response Time (Settling Time) Normally Closed Valve	< 1 sec	700ms	300ms (3-860 sccm N ₂ Eq.) 400ms (861-7200 sccm N ₂ Eq.) 500ms (7201-30000 sccm N ₂ Eq.) <700ms (30001-55000 sccm N ₂ Eq.)
Normally Open Valve	<1.5 sec		
Pressure Insensitivity	Not Applicable		< 5% SP up to 5 psi/sec upstream press. spike
Control Range	2-100% (Normally Closed Valve)	3-100% (Normally Open Valve)	
MultiFlo	standard		
#of Bins	11 bins		
Valve Shut Down (N.C. Valve)	< 1% of F.S.		
Valve Shut Down (N.O. Valve)	2% of F.S.		
Zero Stability	< ± 0.5% F.S. per year		
Temperature Coefficient	Span: 0.05% S.P. per °C, Zero: 0.005% F.S. per °C		

Ratings

Operating Temperature Range	10-50°C		
Differential Pressure Range*	3-860 sccm = 7-45 psid, 861- 7200 sccm = 10-45 psid, 7201-55000 sccm = 15-45 psid *Argon gas applications require an additional 10 psid differential pressure. Low vapor pressure gases require an inlet pressure of > 100 Torr, with vacuum on outlet (example SiCl ₄). Contact Brooks Technical Support for more information.		
Maximum Operating Pressure	500 psia max	100 psia max	
Leak Integrity (external)	1x10 ⁻¹⁰ atm. cc/sec He		

Mechanical

Valve Type	Normally Closed Normally Open Meter (no valve)		
Wetted Materials	GF100: SEMI F20 HP Compliant, 316L VIMVAR, Hastelloy C-22, 316L Stainless Steel, 304 Stainless Steel, KM-45 GF120/GF125: SEMI F20 UHP Compliant, 316L VIMVAR, Hastelloy C-22, 316L Stainless Steel, 304 Stainless Steel, KM-45		
Surface Finish	10µ inch Ra	4µ inch Ra (0.1 µm Ra)	

Diagnostics & Display

Status Lights	MFC Health, Network Status		
Alarms	Control Valve Output, Network Interruption		
Display Type Viewing Angle / Viewing Distance Units Displayed / Resolution	Top Mount Integrated LCD Fixed / 10 feet Flow (%), Temp. (°C), Pressure (psia, kPa) / 0.1 (unit)		

Electrical

Electrical Connection	RS485/Analog via 9-Pin "D" connector, DeviceNet™ via 5-Pin "M12" connector		
Digital Communication	RS485+ (model specific), DeviceNet (model specific), RS485 Diagnostic Port (all models)		
Diagnostic /Service Port	RS485 via 2.5mm jack		
Power Supply/Consumption	DeviceNet: 545mA max. @ +11-25 Vdc., 250mA max. @ 24Vdc RS485/Analog: 6 Watts max @ ±15Vdc. (±10%) or +24 Vdc (±10%)		

Compliance

EMC	EC Directive 2004/108/EC CE: EN61326: 2006 (FCC Part 15 & Canada IC-subset of CE testing)		
Environmental Compliance	RoHS Directive (2011/65/EU) REACH Directive EC 1907/2006		

NOTE: See the following Safe Delivery System (SDS) section for optional detailed specifications

Product Description GF120 Safe Delivery System (SDS®) Option

The **GF120 Safe Delivery System (SDS®)** is Brooks' state-of-the-art low pressure drop mass flow controller for the delivery of sub atmospheric safe delivery system (SDS) gases used in Implant and Etch processes. The Brooks GF120 (SDS) models are available in full scale flow ranges 4-25 sccm (option GF120XSL) or >25 sccm to 1 slpm (option GF120XSD).

These expensive, hazardous gases are adsorbed onto a solid medium within the gas cylinder, remaining below atmospheric pressure despite containing up to 15 times more dopant than conventional pressurized sources.

The amount of gas that can be extracted from the SDS controlled cylinder is highly dependent upon the final cylinder pressure. This is illustrated in SDS desorption species information in the SDS Gas Use Rate Efficiency Curve. Most of the gas is released at pressures below 100 Torr. The minimum cylinder pressure that can be reached is limited by the conductance of the mass flow controller regulating the flow. Most mass flow controllers require a 50 Torr differential pressure at flow rates of 5 sccm. At this 50 Torr limit, only ~65% of the dopant can be extracted from the adsorbent medium at normal operating temperatures. The **GF120 (SDS)** low pressure operation enables a further 30% of the dopant to be extracted, driving significant cost savings in SDS gases and equipment OEE.

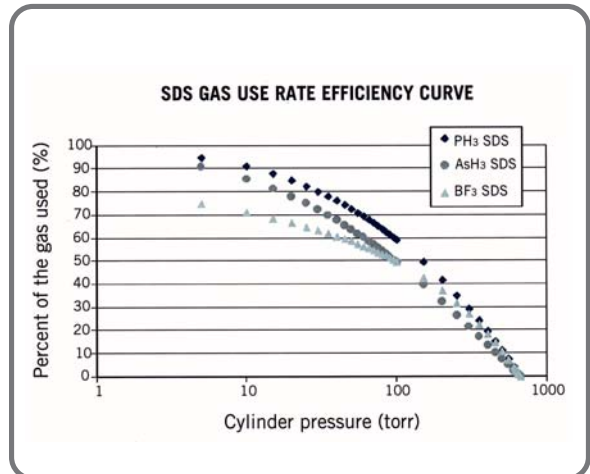

Product Specifications (GF120XSD and GF120XSL) Options

Performance	GF120XSL	GF120XSD
Full Scale Flow Range (N ₂ Eq.)	4 - 25 sccm	>25 to 1 slpm
Gases Supported	AsH ₃ , PH ₃ , BF ₃ , SiF ₄ , Ar, Xe, N ₂ O, N ₂ , GeF ₄ , AsF ₅ , PF ₃ , H ₂ Se, HMDSO, HMDSN, H ₂ O***	
MultiFlo Programmable	Not Configurable	
Flow Accuracy	+/-1% S.P. ≥35% F.S. +/-0.35% F.S. <35% F.S.	
Repeatability & Reproducibility	<+/- 0.15% S.P.	
Zero Stability	<=0.6% F.S. per year	
Settling Time (to within +2% F.S.)	< 3 sec	
Warm Up Time	minimum of 30 minutes	
Leak Integrity	1X10 ⁻¹¹ atm. cc/sec He	
Valve Shut Down (Leaky by)	<1% F.S.	

Operating Conditions	GF120XSD	GF120XSL
Minimum Operating Inlet Pressure*	4 to 20 sccm ≤ 10 Torr >20 to 50 sccm ≤ 20 Torr >50 sccm to 1 slpm ≤ 50 Torr	
Maximum Pressure	500 psia max	
Pressure Insensitivity	Not Available	
Differential Pressure**	10 Torr-30 psid typical (1.33-207 kPa typical)	
Valve Configuration	Normally Closed	
Ambient Temperature Range	10°C-50°C	
Zero Temperature Coefficient	Span: 0.05% SP per °C, Zero: 0.005% F.S. per °C	

*Performance at minimum inlet pressure will be gas and flow range dependent. Consult Technical Support for details.

**Typical pressure drop. Actual pressure drop will be gas and flow dependent. Consult Technical Support for details.

***Consult factory for other gases.

Electrical Interface Options

Base I/O Options

PDC Ordering Code G1

Description: Industry standard Analog / RS485 interface

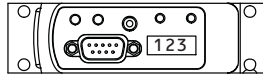

Pin No.	Signals
1	Valve Control
2	Output (0-5 Vdc)
3	+15 Vdc +24 Vdc
4	Pwr Com NC
5	-15 Vdc Pwr Com
6	Setpoint (0-5 Vdc)
7	Signal Common
8	RS-485 (DX+)
9	RS-485 (DX-)

PDC Ordering Code GX

Description: OEM specific Analog / RS485 interface. Display and top plate re-oriented 180°

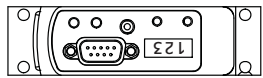

Pin No.	Signals
1	Valve Control
2	Output (0-5 Vdc)
3	+15 Vdc +24 Vdc
4	Pwr Com NC
5	-15 Vdc Pwr Com
6	Setpoint (0-5 Vdc)
7	Signal Common
8	RS-485 (DX+)
9	RS-485 (DX-)

PDC Ordering Code DX

Description: Industry standard ODVA compliant DeviceNet interface

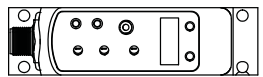

M12 Pin No.	Signals
1	Drain
2	V+ (11-25 Vdc)
3	V-
4	CAN-H
5	CAN-L

PDC Ordering Code TX

Description: Industry standard Analog only interface

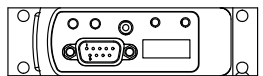

Pin No.	Signals
1	Valve Control
2	Output (0-5 Vdc)
3	+15 Vdc +24 Vdc
4	Pwr Com NC
5	-15 Vdc Pwr Com
6	Setpoint (0-5 Vdc)
7	Signal Common
8	No Connection
9	No Connection

PDC Ordering Code SX

Description: Industry standard Analog 9-Pin Sub D connector and dual RJ11 RS485 ports

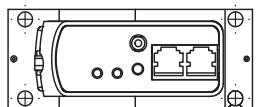

D-Sub Pin No.	Signals
1	Valve Control
2	Output (0-5 Vdc)
3	+15 Vdc +24 Vdc
4	Pwr Com NC
5	-15 Vdc Pwr Com
6	Setpoint (0-5 Vdc)
7	Signal Common
8	Signal Common
9	Valve Test Point

RJ11 J2 Pin No.	Signals
3	RS-485 (DX-)
4	RS-485 (DX+)

PDC Ordering Code BB

Description: Industry standard ODVA compliant DeviceNet interface, Plus a separate Analog 0-5 Vdc Connector

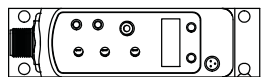

M12 Pin No.	Signals
1	Drain
2	V+ (11-25 Vdc)
3	V-
4	CAN-H
5	CAN-L

HIROSE Pin No.	Signals
1	Flow Out
2	AGND
3	GPIO CAP0
4	GHD Earth

All Base I/O options include:
Diagnostic port communication RS485 via 2.5mm jack

I/O Options Using Base Model and Adapter Cable

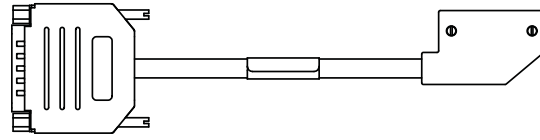

A range of low profile adapter cables have been developed to support replacing older generation MFC's with different pinout configurations. The base MFC will be either a G1, TX or SX configuration, depending on the product being replaced.

PDC Ordering Code UX

Description: SX base I/O with 7003550 adapter for compatibility with Unit UDU15

Pin No	Signals
9	VALVE OFF
6	OUTPUT (0-5 VDC)
4	+15 VDC +24 VDC
7	PWR COM NC
11	-15 VDC PWR COM
15	SETPOINT (0-5 VDC)
1,13,14	SIGNAL COMMON
2	ZERO ALARM
12	VALVE TEST POINT
8	CASE GROUND
3,5,10	NO CONNECTION

PDC Ordering Code: T1

Description: TX base I/O with 7003551 adapter for compatibility with IFlow DB15 & TN 15 pin

Pin No	Signals
15	VALVE OFF
2	OUTPUT (0-5 Vdc)
5	+15 VDC +24 VDC
1	PWR COM NC
6	-15 VDC PWR COM
8	SETPOINT (0-5 VDC)
9	COMMON
10	COMMON
14	CASE GROUND
3,4,7	NO CONNECTION
11,12,13	NO CONNECTION

PDC Ordering Code: FX / JX

Description: SX base I/O with 7003069 (FX)/7001814 (JX) adapter for compatibility with Unit UDF9/UDJ9

Pin No	Signals
1	VALVE CONTROL*
2	OUTPUT (0-5 VDC)
3	+15 VDC +24 VDC
4	PWR COM NC
5	-15 VDC PWR COM
6	SETPOINT (0-5 VDC)
7	SIGNAL COMMON
8	SIGNAL COMMON
9	VALVE TEST POINT

PDC Ordering Code: EX

Description: GX base I/O with 7003083 adapter for compatibility with Unit "E", "IN", "L", "R"

Pin No	Signals
J	VALVE OFF
3	OUTPUT (0-5 VDC)
4	+15 VDC +24 VDC
2	PWR COM NC
F	-15 VDC PWR COM
A	SETPOINT (0-5 VDC)
B,C,10	SIGNAL COMMON
1	CASE GROUND
5, 6, 8, 9	NOT CONNECTED
I, L, D, E, H	NOT CONNECTED
7, G	KEY WAY

RJ11 J2 Pin No	RJ11 J3 Pin No	Signals
3	3	RS-485 (DX-)
4	4	RS-485 (DX+)

PDC Ordering Code: KX

Description: G1 base I/O with 7003298 adapter for compatibility with Unit UDK15

Pin No	Signals
3	VALVE CONTROL
2	OUTPUT (0-5 VDC)
7	+15 VDC +24 VDC
5	PWR COM NC
6	-15 VDC PWR COM
8	SETPOINT (0-5 VDC)
11,12	SIGNAL COMMON
15	CASE GROUND
1, 4, 9, 10, 13, 14	NO CONNECTION

PDC Ordering Code: BX

Description: G1 base I/O with 7003590 adapter for compatibility with Brooks 15-Pin D

Pin No	Signals
12	VALVE OVERRIDE
2	OUTPUT (0-5 VDC)
5	+15 VDC +24 VDC
9	PWR COM NC
6	-15 VDC PWR COM
8	SETPOINT (0-5 VDC)
1,10	SIGNAL COMMON
3,4,7,11	NO CONNECTION
13,14,15	NO CONNECTION

Other adapter options are available for the GF Series. Please contact Brooks Customer Service for more information.

Product Dimensions

Downport Configurations

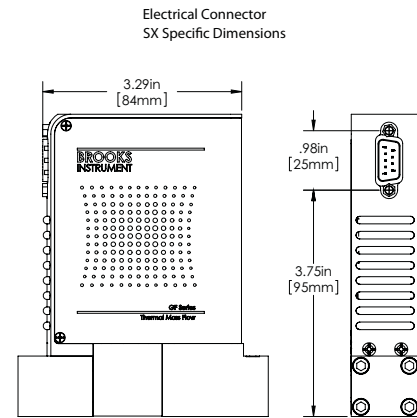
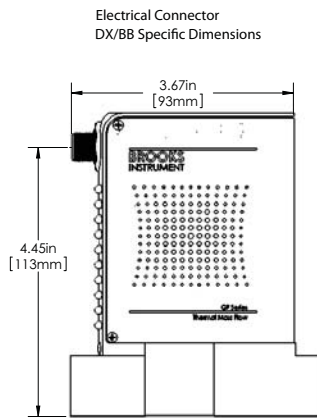
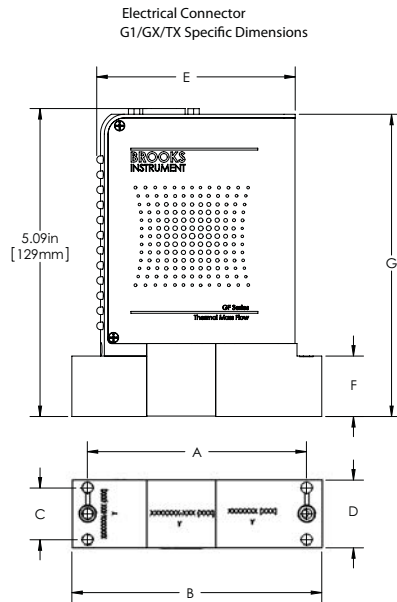

Fitting Option Code	Seal Type	Dim A	Dim B	Dim C	Dim D	Dim E	Dim F	Dim G
CX	C-SEAL	92mm [3.62in]	105mm [4.13in]	22mm [0.86in]	28mm [1.12in]	83mm [3.28in]	25mm [1.00in]	127mm [5.00in]
EX	W-SEAL	79.8mm [3.14in]	93mm [3.66in]	30mm [1.18in]	39mm [1.53in]	72mm [2.82in]	25mm [1.00in]	127mm [5.00in]
WX	W-SEAL	92mm [3.62in]	105mm [4.13in]	22mm [0.86in]	28mm [1.12in]	83mm [3.28in]	25mm [1.00in]	127mm [5.00in]
DX	C-SEAL	79.8mm [3.14in]	93mm [3.66in]	22mm [0.86in]	28mm [1.12in]	72mm [2.82in]	25mm [1.00in]	127mm [5.00in]
YX	W-SEAL	79.8mm [3.14in]	93mm [3.66in]	22mm [0.86in]	28mm [1.12in]	72mm [2.82in]	25mm [1.00in]	127mm [5.00in]
AX	C-SEAL	92mm [3.62in]	105mm [4.13in]	30mm [1.18in]	39mm [1.53in]	83mm [3.28in]	25mm [1.00in]	127mm [5.00in]
BX	W-SEAL	92mm [3.62in]	105mm [4.13in]	30mm [1.18in]	39mm [1.53in]	83mm [3.28in]	25mm [1.00in]	127mm [5.00in]
LX	C-SEAL	92mm [3.62in]	105mm [4.13in]	22mm [0.86in]	28mm [1.12in]	83mm [3.28in]	25mm [1.00in]	127mm [5.00in]

VCR Configurations

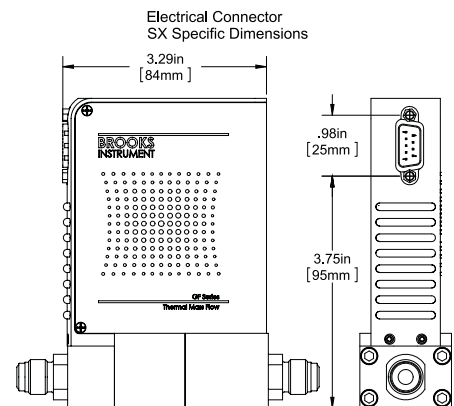
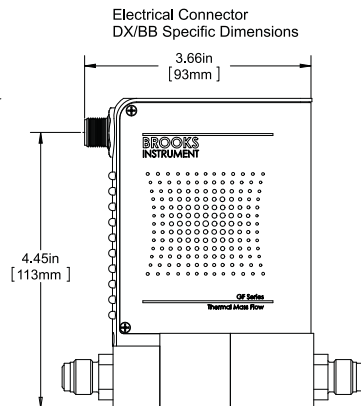
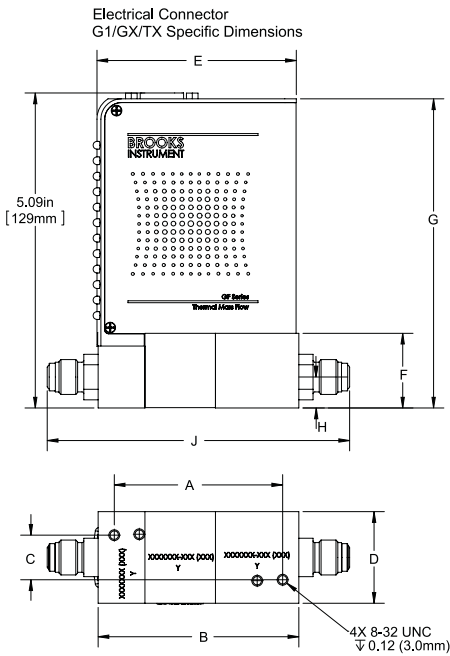

Fitting Option Code	VCR	Dim A	Dim B	Dim C	Dim D	Dim E	Dim F	Dim G	Dim H	Dim J
VX	1/4"	69mm [2.72in]	82mm [3.24in]	18mm [0.72in]	38mm [1.49in]	83mm [3.28in]	31mm [1.21in]	127mm [5.0in]	13mm [0.50in]	124mm [4.88in]
VS	1/4"	69mm [2.72in]	82mm [3.24in]	18mm [0.72in]	28.4mm [1.12in]	83mm [3.28in]	31mm [1.21in]	127mm [5.0in]	13mm [0.50in]	124mm [4.88in]

Model Code

Code Description	Code Option	Option Description
I. Base Model Code	GF	High Purity/Ultra High Purity Digital Mass Flow Controllers
II. Package / Finish Specifications	100	Flow range 3 sccm -55 slpm N ₂ Eq.; ± 1.0% SP Accuracy; 1 sec Response; 10 Ra
	120	Flow range 3 sccm -55 slpm N ₂ Eq.; + 1.0% SP Accuracy; 700 msec Response; 4 Ra
	125	Pressure Transient Insensitive (PTI) Flow range 3 sccm -55 slpm N ₂ Eq.; + 1.0% SP Accuracy; 300-700 msec Response; 4 Ra
III. Configurability	C	MultiFlo capable. Standard bins or specific gas/range may be selected.
	X	Not MultiFlo capable. Specific gas/range required. (must select w/ SD, SL or HA special application)
IV. Special Application	XX	Standard
	SL	Safe Delivery System (GF120 Only) Full scale flow range; 4 to 25 sccm, Nitrogen Equivalent
	SD	Safe Delivery System (GF120 Only) Full scale flow range; >25 sccm to 1 slpm, Nitrogen Equivalent
V. Valve Configuration	O	Normally Open valve (not available with SD, SL or HA options)
	C	Normally Closed valve (must select with SD, SL or HA special application)
	M	Meter (No Valve)
VI. Gas or SH MultiFlo Bin	XXXX XXXX	Specific Gas Code & Range, i.e. "0004" = Argon and "010L" = 10 slpm (must select w/ SD, SL or HA special application).
	SH40 010C	Standard Configuration #40, 3-10 sccm Nitrogen Equivalent (0° C Reference)
	SH41 030C	Standard Configuration #41, 11-30 sccm Nitrogen Equivalent (0° C Reference)
	SH42 092C	Standard Configuration #42, 31-92 sccm Nitrogen Equivalent (0° C Reference)
	SH43 280C	Standard Configuration #43, 93-280 sccm Nitrogen Equivalent (0° C Reference)
	SH44 860C	Standard Configuration #44, 281-860 sccm Nitrogen Equivalent (0° C Reference)
	SH45 2.6L	Standard Configuration #45, 861-2600 sccm Nitrogen Equivalent (0° C Reference)
	SH46 7.2L	Standard Configuration #46, 2601-7200 sccm Nitrogen Equivalent (0° C Reference)
	SH47 015L	Standard Configuration #47, 7201-15000 sccm Nitrogen Equivalent (0° C Reference)
	SH48 030L	Standard Configuration #48, 15001-30000 sccm Nitrogen Equivalent (0° C Reference)
	SH49 040L	Standard Configuration #49, 30001-40000 sccm Nitrogen Equivalent (0° C Reference)
SH50 055L	Standard Configuration #50, 40001-55000 sccm Nitrogen Equivalent (0° C Reference)	
VII. Fitting	VX	1-1/2" body width, 124mm 1/4" VCR male
	VS	1-1/8" body width, 124mm 1/4" VCR male
	CX	1-1/8" body width, 92mm C Seal
	DX	1-1/8" body width, 79.8mm C Seal
	EX	1-1/2" body width, 79.8mm W Seal
	WX	1-1/8" body width, 92mm W Seal
	YX	1-1/8" body width, 79.8mm W Seal
	AX	1-1/2" body width, 92mm C Seal
	BX	1-1/2" body width, 92mm W Seal
	LX	1-1/8" body width, 92mm C Seal w/Poke Yoke
	AS	1-1/2" body width, 92mm 0.440" large bore C Seal (only for bins SH45-SH50)
	VIII. Downstream Condition	A
V		Vacuum; Default for SD, SL and HA special application
IX. Sensor	O	Default Sensor Orientation

Model Code continued on next page.

Model Code (continued)

Code Description	Code Option	Option Description									
X. Connector	BX	Cable adapter to 15 pin D Brooks (Unit "B", "N") adapts G1 base									
	EX	Cable adapter to Card Edge (w/out VTP), RS485 through RJ11 jacks (Unit "E"; IN "L", "R") adapts GX base (Not Available on 79.8mm fitting DX, YX, EX)									
	FX	Cable adapter with 9 pin STEC pin-out & jack screws (w/VTP) (Unit "F", "O") adapts SX base									
	GX	9-Pin D with RS485 (Unit "G"); display and overlay 180° orientation (Not Available on 79.8mm fitting DX, YX, EX)									
	G1	9-Pin D with RS485 (Unit "G") (Not Available on 79.8mm fitting DX, YX, EX)									
	JX	Cable adapter with 9 pin STEC pin-out & jack screws (w/VTP) (Unit "J", "W") adapts SX base									
	KX	Cable adapter to MKS 15-Pin D (Unit "K") adapts G1 base									
	SX	9 pin D with STEC pin-out (w/VTP) (Unit "S", "Q")									
	TX	9 pin D with UDT9 pin-out (UDT9)									
	T1	Cable adapter to 15 pin D (IFlow DB15 & TN 15 pin) adapts TX base (Not Available on 79.8mm fitting DX, YX, EX)									
	UX	Cable adapter to 15 pin D (w/VTP) (Unit & TN "U") adapts SX base									
	BB	DeviceNet™ Analog (Not Available on 79.8mm fitting DX, YX, EX)									
		DeviceNet Standard Configuration Parameters									
		I/O	Connector	Power On State	Full Scale Setting	Full Scale Setting	Full Scale Setting	Poll IO Instance Producer	Poll IO Instance Consumer	Poll IO State Transition	External Baud Rate
	D0	DeviceNet	5 Pin Micro	Idle	Count	Integer	6000h	2	7	Executing	500KB
	D1	DeviceNet	5 Pin Micro	Idle	Count	Integer	6000h	21	7	Executing	500KB
	D2	DeviceNet	5 Pin Micro	Idle	SCCM	Float	7FFFh	13	19	Executing	500KB
	D3	DeviceNet	5 Pin Micro	Idle	Count	Integer	6000h	22	7	Executing	500KB
	D4	DeviceNet	5 Pin Micro	Executing	Count	Integer	6000h	22	8	Executing	500KB
	D5	DeviceNet	5 Pin Micro	Idle	Count	Integer	6000h	6	8	Executing	500KB
D6	DeviceNet	5 Pin Micro	Idle	Count	Integer	7FFFh	3	7	Executing	500KB	
D7	DeviceNet	5 Pin Micro	Idle	Count	Integer	7FFFh	6	8	Executing	500KB	
D8	DeviceNet	5 Pin Micro	Idle	Count	Integer	6000h	3	7	Executing	500KB	
D9	DeviceNet	5 Pin Micro	Executing	Count	Integer	6000h	2	7	Executing	500KB	
DA	DeviceNet	5 Pin Micro	Idle	Count	Integer	7FFFh	22	7	Executing	500KB	
DB	DeviceNet	5 Pin Micro	Idle	Count	Integer	6000h	22	8	Executing	500KB	
DC	DeviceNet	5 Pin Micro	Idle	Count	Integer	7FFFh	3	7	Idle	500KB	
DD	DeviceNet	5 Pin Micro	Executing	Count	Integer	7FFFh	22	8	Executing	500KB	
DE	DeviceNet	5 Pin Micro	Executing	Sccm	Float	6000h	15	19	Executing	500KB	
DX	DeviceNet	5 Pin Micro	To be defined by CSR								

Code Description	Code Option	Option Description
XI. Customer Special Request	XXXX	Customer Special Request Number; required with "DX, BB" Conn. Option to define DNet settings
XII. Auto Shut-Off	A	Auto Shut-Off (Included) Default for SD and SL special application
	X	Auto Shut-Off (Not Included) (Must be selected for meter)
XIII. Auto Zero	X	Auto Zero (Not Included)
XIV. Reference Temperature	000	0°C Reference Calibration (Standard) - Default Setting

Sample Standard Model Code

I	II	III	IV	V	VI	VII	VIII	IX	X	XI	XII	XIII	XIV
GF	100	C	XX	M	- SH40010C	- VX	A	0	GX	- XXXX	A	X	- 000

Sample Safe Delivery System (SDS) Model Code

I	II	III	IV	V	VI	VII	VIII	IX	X	XI	XII	XIII	XIV
GF	120	X	SD	C	- XXXXXXXX	- EX	V	0	SX	- XXXX	A	X	- 000

Brooks Service and Support

Brooks is committed to assuring all of our customers receive the ideal flow solution for their application, along with outstanding service and support to back it up. We operate first class repair facilities located around the world to provide rapid response and support. Each location utilizes primary standard calibration equipment to ensure accuracy and reliability for repairs and recalibration and is certified by our local Weights and Measures Authorities and traceable to the relevant International Standards.

Visit www.BrooksInstrument.com to locate the service location nearest to you.

START-UP SERVICE AND IN-SITU CALIBRATION

Brooks Instrument can provide start-up service prior to operation when required. For some process applications, where ISO-9001 Quality Certification is important, it is mandatory to verify and/or (re)calibrate the products periodically. In many cases this service can be provided under in-situ conditions, and the results will be traceable to the relevant international quality standards.

CUSTOMER SEMINARS AND TRAINING

Brooks Instrument can provide customer seminars and dedicated training to engineers, end users, and maintenance persons.

Please contact your nearest sales representative for more details.

Due to Brooks Instrument's commitment to continuous improvement of our products, all specifications are subject to change without notice.

TRADEMARKS

Brooks is a trademark of Brooks Instrument, LLC
All other trademarks are the property of their respective owners.



Global Headquarters

Brooks Instrument
407 West Vine Street
Hatfield, PA
19440-0903 USA

Toll-Free (USA): 888-554-FLOW
T: 215-362-3500
F: 215-362-3745

BrooksAM@BrooksInstrument.com

A list of all Brooks Instrument locations and contact details can be found at www.BrooksInstrument.com

©Copyright 2016 Brooks Instrument, LLC All rights reserved. Printed in U.S.A.

BROOKS[®]
INSTRUMENT

GF Series

GF101/GF121/GF126

Thermal Mass Flow



GF High Flow Series

High Purity/Ultra-High Purity High Flow Digital Mass Flow Devices

Overview

Designed for semiconductor, MOCVD, and other gas flow control applications that require a high purity all-metal flow path, the Brooks GF Series mass flow controllers deliver outstanding performance, reliability, and flexibility. The GF101/121/126 extends the GF family to support flow rates up to 300 slpm N₂ equivalent. The high flow design utilizes the proven GF sensor design and electronics. This high flow product provides excellent flow stability for purge lines in CVD, LPCVD, Diffusion, Epi processes, semiconductor chamber clean processes and MOCVD purge flows.

Product Description

Designed for high-flow applications like purge, the GF101/121/126 has all of the features/benefits of the GF100/120/125, but with extended performance for flow rates up to 300 slpm. Compared with competitive products offering a similar flow rate, the compact footprint of the GF101/121/126 allows users to design smaller, more efficient systems. It also provides better actual process gas accuracy over devices that use traditional single point conversion factors when switching to a new gas. The GF101/121/126 Series features an all metal seal flow path for durability and high leak integrity, precise, stable flow control with fast Sub-1 second settling times and 1% of reading accuracy to ensure reliable flow measurement or control in demanding gas flow applications. The GF101/121/126 achieves excellent internal to external leak integrity. A wide range of digital and analog I/O options offers the broadest range of communication protocols making the GF101/121/126 an ideal upgrade for existing MFCs.

Built on a common platform and interface, this series now enables an entire system to use one product platform:

- GF101/121/126 based on the same technology and design as the low flow GFs
 - Same sensor
 - Same electronics
 - Same low power support
- Smaller footprint than competitive MFCs
- Handles flow rates up to 300 slpm
- Metal seal for durability and high leak integrity
- Proprietary sensor technology
- Precise flow control with fast sub-1 second settling time
- 1% of reading accuracy
- Corrosion-resistant Hastelloy C-22 sensor tube

Product Description (continued)

Ultra Fast Response

By combining Brooks' patented flow sensor technology with a high speed ARM processor and fast acting diaphragm free valve assembly, the GF101/GF121/GF126 Series delivers up to 2 times faster response and settling time compared to other mass flow controllers, enabling:

- Reduced diverted gas consumption and associated abatement costs
- For processes requiring a slow ramped gas turn-on or time critical transitions between flow rates. A user programmable ramp function is provided
- Improved gas blending and dilution in MOCVD

Pressure Tolerant Flow Control

The GF High-Flow's hydraulically balanced valve is inherently less sensitive to line pressure disturbances caused by regulator droop and popping that can drive the traditional (valve) MFC's to over compensate and ring, resulting in flow disturbance that can impact the process, trip excess flow alarms or stir up particles.

Advanced Thermal Flow Measurement Sensor

Brooks' proprietary sensor technology combines:

- Improved signal to noise performance for improved accuracy at low setpoints
- Improved reproducibility at elevated temperatures through new isothermal packaging, onboard conditioning electronics with ambient temperature sensing and compensation
- Improved long-term stability through enhanced sensor manufacturing and burn in process
- Highly corrosion resistant Hastelloy C-22 sensor tube
- Optimized temperature profile for gases prone to thermal decomposition
- Unique orthogonal sensor mounting orientation
 - Eliminates sensor drift caused by valve heating effects
 - Eliminates thermal siphoning effects for the most common mounting orientations

High Purity Flow Path

All metal, corrosion resistant flow path with reduced surface area and un-swept volumes for faster dry-down during purge steps:

- SEMI F-20 compliant wetted flow path
- 5 μ inch Ra max surface finish standard (10 μ inch Ra on GF101)

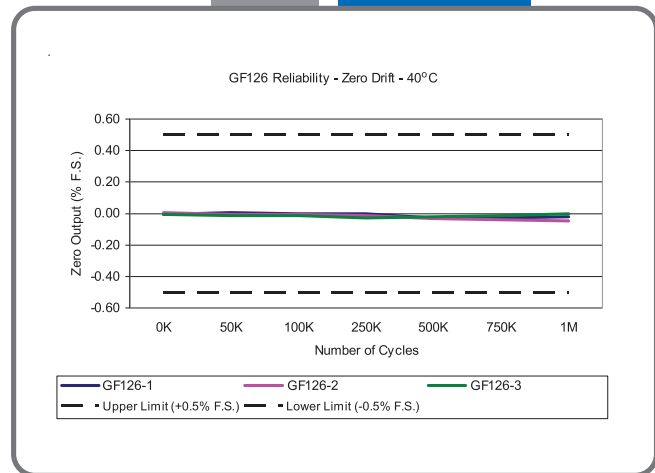
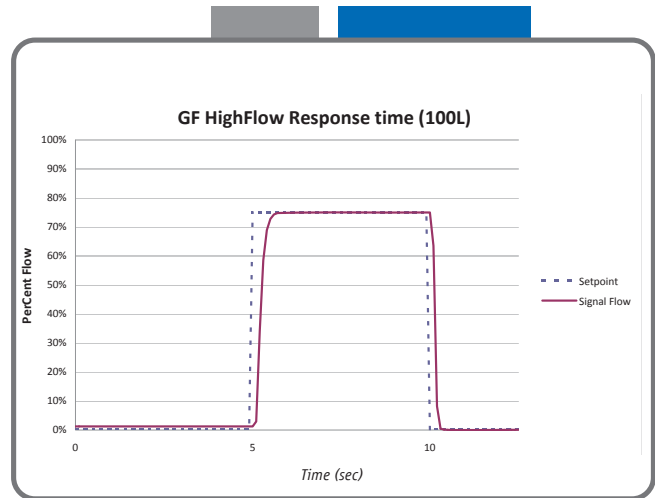

Product Description (continued)

Extensive Mechanical Configuration Support

GF101/GF121/GF126 Series supports all metal seal / UHP industry gas connection interface standards for full OEM and process coverage

- 92 mm, C Seal on 1.5" body
- 114 mm, C Seal on 1.5" body
- 134.2 mm, 1/2" VCR male on 1.5" body
- 150.4 mm, 1/2" VCR on 1.5 body
- 166 mm, 1/2" VCR on 1.5" body
- 168.6 mm, 1/2" VCR on 1.5" body

Accessories

318Z137BNA: 1/2" VCR adapter to extend 134.2 mm lay length to 177 mm lay length

318Z138BNA: 1/2" VCR adapter to extend 134.2 mm lay length to 192.4 mm lay length

Enhanced Diagnostics

The mass flow controller remains the most complex and critical component in gas delivery systems. When dealing with UHP gas distribution or highly toxic or corrosive gases, removing the mass flow controller to determine if it is faulty should be the last resort. In response to this, Brooks pioneered smarter mass flow controllers with embedded self test routines and introduced an independent diagnostic/service port to provide the user with a simple interface, for troubleshooting without disturbing flow controller operation.

User Interface

The user interface has a high visibility LCD display that provides a local indication of Flow (%), Temperature (°C), Pressure (PSIA/KPa) and Network Address, selectable through the Display button. A Zero button provides a simple means to re-zero the mass flow controller as part of scheduled maintenance. The display is rotatable with a push button to enable improved readability based on how the MFC is mounted.

Communication Interface

The GF101/GF121/GF126 Series supports analog 0-5 Vdc, RS485, and DeviceNet™ communication protocols. A range of low profile adapter cables facilitate replacing older mass flow

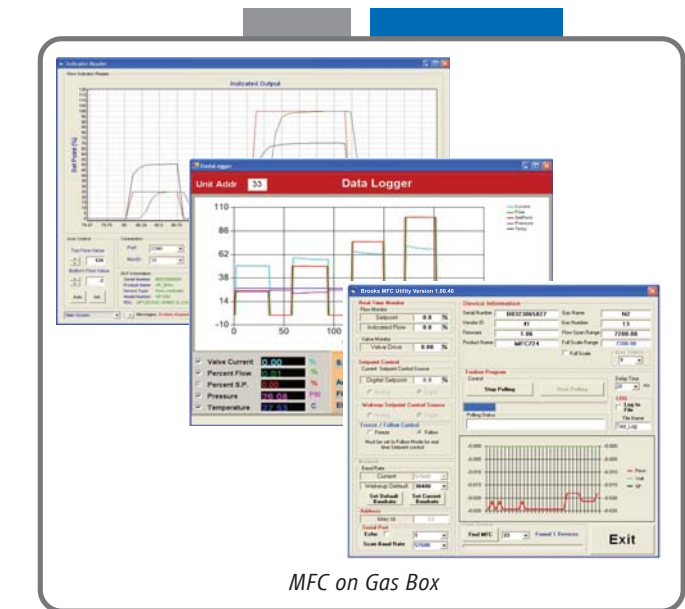

MFC on Gas Box



Communication Interface

controllers with the GF101/GF121/GF126 Series eliminating the need to carry mass flow controllers of same gas/range but different electrical connectors.

Features and Benefits

Features	Benefits
Metal Seal	High leak integrity. No periodic replacement of aging seals necessary
Adaptable Mechanical Configurations	Compact footprint enables easy retrofit to existing systems
Metrology	Measurement accuracy is traceable to international standards
User Accessible Service Port with Advanced Diagnostics with User-Friendly Interface	Convenient interface to diagnostics for maximum uptime. Ensures device is operating within user specified limits for high yield and maximum uptime
Corrosion Resistant Hastelloy T-Rise Sensor	Provides unmatched long-term sensor stability ensuring maximum yield and throughput
Pressure Transient Insensitivity (PTI)	Tighter process control

Product Specifications

Performance	GF101	GF121	GF126
Full Scale Flow Range (N ₂ Eq.)	55 to 300 slm		
Flow Accuracy	±1% S.P. > 35-100%, ±0.35% F.S. 2-35%		
Repeatability & Reproducibility	< ± 0.15% S.P.		
Linearity	± 0.5% F.S. (included in accuracy)		
Response Time (Settling Time) Normally Closed Valve	< 1 sec		
Pressure Transducer			Ability to measure inlet pressure
Control Range	5-100% (Normally Closed Valve)		
MultiFlo	Standard (All typical high flow rate process gases & mixtures supported)		
# of Bins	4 Bins		
Control Range	5-100% (Normally Closed Valve)		
Valve Shut Down (N.C. Valve)	< 2% of F.S. @ 30 N ₂ psig/atm out		
Zero Stability	< ± 0.5% F.S. per year		
Temperature Coefficient	Span: 0.05% S.P. per °C, Zero: 0.005% F.S. per °C		

Ratings

Operating Temperature Range	10-50°C
Differential Pressure Range	30-90 psid
Maximum Operating Pressure	Controller: 75 psig / Meter: 150 psig
Leak Integrity (external)	1x10 ⁻¹⁰ atm. cc/sec He

Mechanical

Valve Type	Normally Closed Meter (no valve)	
Wetted Materials	GF101: SEMI F20 HP Compliant, 316L VIMVAR, Hastelloy C-22, 316L Stainless Steel, 304 Stainless Steel, KM-45 GF121/GF126: SEMI F20 UHP Compliant, 316L VIMVAR, Hastelloy C-22, 316L Stainless Steel, 304 Stainless Steel, KM-45	
Surface Finish	10μ inch Ra	5μ inch Ra (0.1 μm Ra)

Diagnostics & Display

Status Lights	MFC Health, Network Status
Alarms	Control Valve Output, Network Interruption
Display Type Viewing Angle / Viewing Distance Units Displayed / Resolution	Top Mount Integrated LCD Fixed / 10 feet Flow (%), Temp. (°C), Pressure (psia, kPa) / 0.1 (unit)

Electrical

Electrical Connection	RS485/Analog via 9-Pin "D" connector, DeviceNet™ via 5-Pin "M12" connector
Digital Communication	RS485+ (model specific), DeviceNet (model specific), RS485 Diagnostic Port (all models)
Diagnostic /Service Port	RS485 via 2.5mm jack
Power Supply/Consumption	DeviceNet: 545 mA max. @ +11-25 Vdc., 250mA max. @ 24 Vdc (Under typical operating conditions) RS485/Analog: 6 Watts max @ ±15 Vdc. (±10%) (Under typical operating conditions)

Compliance

EMC	EC Directive 2004/108/EC CE: EN61326: 2006 (FCC Part 15 & Canada IC-subset of CE testing)
Environmental Compliance	RoHS Directive (2011/65/EU) REACH Directive EC 1907/2006

Electrical Interface Options

Base I/O Options

PDC Ordering Code G1

Description: Industry standard Analog / RS485 interface

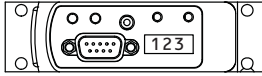

Pin No.	Signals	
1	Valve Control	
2	Output (0-5 Vdc)	
3	+15 Vdc	+24 Vdc
4	Pwr Com	NC
5	-15 Vdc	Pwr Com
6	Setpoint (0-5 Vdc)	
7	Signal Common	
8	RS-485 (DX+)	
9	RS-485 (DX-)	

PDC Ordering Code SX

Description: Industry standard Analog 9-Pin Sub D connector and dual RJ11 RS485 ports

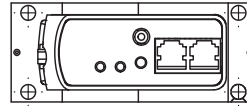

D-Sub Pin No.	Signals	
1	Valve Control	
2	Output (0-5 Vdc)	
3	+15 Vdc	+24 Vdc
4	Pwr Com	NC
5	-15 Vdc	Pwr Com
6	Setpoint (0-5 Vdc)	
7	Signal Common	
8	Signal Common	
9	Valve Test Point	

RJ11 J2 Pin No.	Signals
3	RS-485 (DX-)
4	RS-485 (DX+)

PDC Ordering Code DX

Description: Industry standard ODVA compliant DeviceNet interface

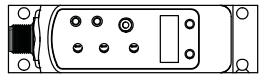

M12 Pin No.	Signals
1	Drain
2	V+ (11-25 Vdc)
3	V-
4	CAN-H
5	CAN-L

All Base I/O options include: Diagnostic port communication RS485 via 2.5mm jack

I/O Options Using Base Model and Adapter Cable

A range of low profile adapter cables have been developed to support replacing older generation MFC's with different pinout configurations. The base MFC will be either a G1 or SX configuration, depending on the product being replaced.

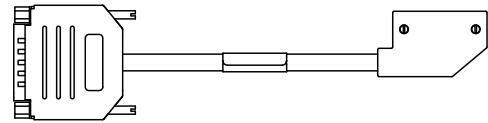

PDC Ordering Code UX

Description: SX base I/O with 7003550 adapter for compatibility with Unit UDU15

Pin No	Signals	
9	VALVE OFF	
6	OUTPUT (0-5 VDC)	
4	+15 VDC	+24 VDC
7	PWR COM	NC
11	-15 VDC	PWR COM
15	SETPOINT (0-5 VDC)	
1,13,14	SIGNAL COMMON	
2	ZERO ALARM	
12	VALVE TEST POINT	
8	CASE GROUND	
3,5,10	NO CONNECTION	

PDC Ordering Code: FX / JX

Description: SX base I/O with 7003069 (FX)/7001814 (JX) adapter for compatibility with Unit UDF9/UDJ9

Pin No	Signals	
1	VALVE CONTROL*	
2	OUTPUT (0-5 VDC)	
3	+15 VDC	+24 VDC
4	PWR COM	NC
5	-15 VDC	PWR COM
6	SETPOINT (0-5 VDC)	
7	SIGNAL COMMON	
8	SIGNAL COMMON	
9	VALVE TEST POINT	

PDC Ordering Code: EX

Description: G1 base I/O with 7003083 adapter for compatibility with Unit "E", IN "L", "R"

Pin No	Signals	
J	VALVE OFF	
3	OUTPUT (0-5 VDC)	
4	+15 VDC	+24 VDC
2	PWR COM	NC
F	-15 VDC	PWR COM
A	SETPOINT (0-5 VDC)	
B,C,10	SIGNAL COMMON	
1	CASE GROUND	
5, 6, 8, 9	NOT CONNECTED	
I, D, E, H	NOT CONNECTED	
7, G	KEY WAY	

RJ11 J2 Pin No	RJ11 J3 Pin No	Signals
3	3	RS-485 (DX-)
4	4	RS-485 (DX+)

PDC Ordering Code: KX

Description: G1 base I/O with 7003298 adapter for compatibility with Unit UDK15

Pin No	Signals	
3	VALVE CONTROL	
2	OUTPUT (0-5 VDC)	
7	+15 VDC	+24 VDC
5	PWR COM	NC
6	-15 VDC	PWR COM
8	SETPOINT (0-5 VDC)	
11,12	SIGNAL COMMON	
15	CASE GROUND	
1, 4, 9, 10, 13, 14	NO CONNECTION	

PDC Ordering Code: BX

Description: G1 base I/O with 7003590 adapter for compatibility with Brooks 15-Pin D

Pin No	Signals	
12	VALVE OVERRIDE	
2	OUTPUT (0-5 VDC)	
5	+15 VDC	+24 VDC
9	PWR COM	NC
6	-15 VDC	PWR COM
8	SETPOINT (0-5 VDC)	
1,10	SIGNAL COMMON	
3,4,7,11	NO CONNECTION	
13,14,15	NO CONNECTION	

Other adapter options are available for the GF Series. Please contact Brooks Customer Service for more information.

Product Dimensions

DNET

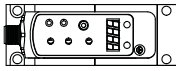

RS485

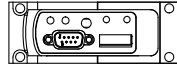

RS485/RJ11

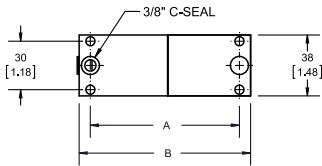
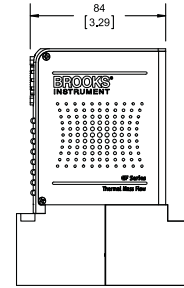
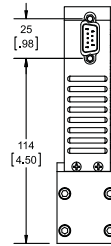
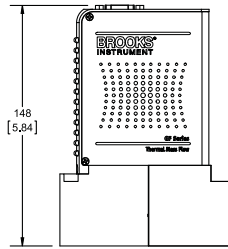
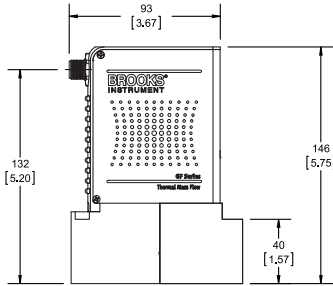
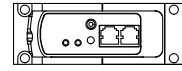

Fitting Option Code	Seal Type	Dim A	Dim B
C1	3/8" C-Seal	92 mm [3.62 in]	106 mm [4.17 in]
C2	3/8" C-Seal	114 mm [4.49 in]	127 mm [5.00 in]

DNET

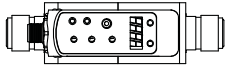

RS485

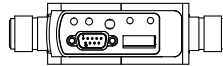

RS485/RJ11

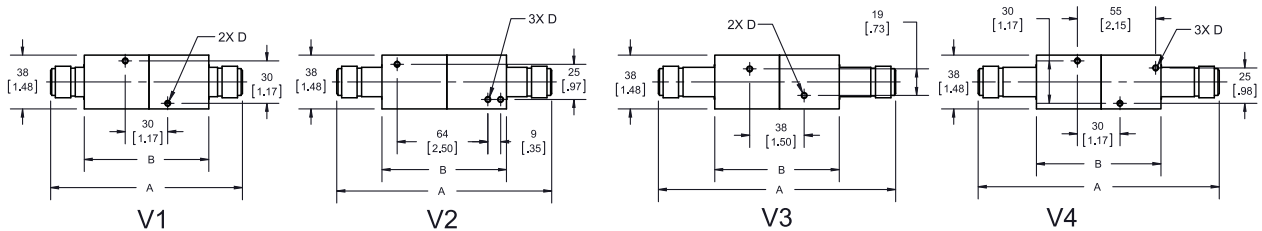
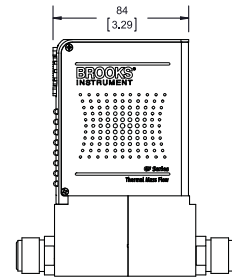
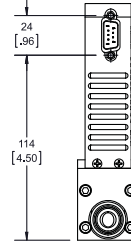
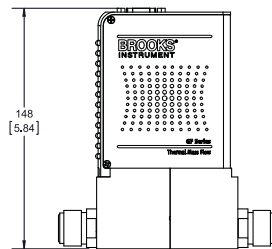
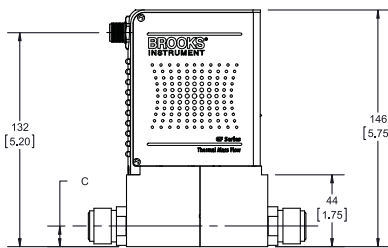
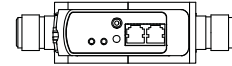

Fitting Option Code	Seal Type	Dim A	Dim B	Dim C	Dim D
V1	1/2" VCR	134.2 mm [5.28 in]	87 mm [3.43 in]	12.7 mm [0.50 in]	M4 X 0.7 X 5.8 [0.23] DEEP
V2	1/2" VCR	150.4 mm [5.92 in]	87 mm [3.43 in]	15.5 mm [0.61 in]	M4 X 0.7 X 5.8 [0.23] DEEP
V3	1/2" VCR	166 mm [6.54 in]	87 mm [3.43 in]	12.4 mm [0.49 in]	M4 X 0.7 X 5.8 [0.23] DEEP
V4	1/2" VCR	168.6 mm [6.64 in]	87 mm [3.43 in]	16.0 mm [0.63 in]	M4 X 0.7 X 5.8 [0.23] DEEP

Model Code

Code Description	Code Option	Option Description									
I. Base Model Code	GF	High Purity/Ultra High Purity Digital Mass Flow Controllers									
II. Package / Finish Specifications	101	Flow range 55 - 300 slm N2 Eq.; 10 Ra HP wetted flow path									
	121	Flow range 55 - 300 slm N2 Eq.; 5 Ra UHP wetted flow path									
	126	Flow range 55 - 300 slm N2 Eq.; 5 Ra UHP wetted flow path & integrated pressure measurement									
III. Configurability	C	MultiFlo capable									
	X	Not configurable									
IV. Special Application	XX	Standard									
V. Valve Configuration	C	Normally Closed valve									
	M	Meter (No Valve)									
VI. Gas or SH MultiFlo Bin	XXXX XXXX	Specific Gas Code & Range, i.e. "0004" = Argon and "100L" = 100 slpm									
	SH51 055L	Standard Configuration #51, 55,001 sccm N2 Equivalent (0°C Reference) Special Bin for low density gases, e.g. 73,002-120,000 He, 100,002-170,000 H2									
	SH52 100L	Standard Configuration #52, 55,002-100,000 sccm N2 Equivalent (0°C Reference)									
	SH53 200L	Standard Configuration #53, 100,001-200,000 sccm N2 Equivalent (0°C Reference)									
	SH54 300L	Standard Configuration #54, 200,001-300,000 N2 Equivalent (0°C Reference)									
VII. Fitting	V1	1-1/2" body width, 134mm 1/2" VCR male									
	V2	1-1/2" body width, 150.4mm 1/2" VCR male									
	V3	1-1/2" body width, 166mm 1/2" VCR male									
	V4	1-1/2" body width, 168.6mm 1/2" VCR male									
	Order V1 + 318Z137BNA	1-1/2" body width, 177mm 1/2" VCR male									
	Order V1 + 318Z138BNA	1-1/2" body width, 192.4mm 1/2" VCR male									
	C1	1-1/2" body width, 92mm 3/8" C Seal									
	C2	1-1/2" body width, 114mm 3/8" C Seal									
VIII. Downstream Condition	A	Atmosphere									
	V	Vacuum									
IX. Sensor	O	Default Sensor Orientation									
X. Connector	BX	Cable adapter to 15 pin D Brooks (Unit "B","N"); adapts G1 base									
	EX	Cable adapter to card edge (w/out VTP), RS485 through RJ11 jacks (Unit "E"; IN "L", "R"); adapts G1 base									
	FX	Cable adapter with 9 pin STEC pin-out & jack screws (w/VTP) (Unit "F","O"); adapts SX base									
	G1	9-Pin D with RS485 (Unit "G")									
	JX	Cable adapter with 9 pin STEC pin-out & jack screws (w/VTP) (Unit "J","W"); adapts SX base									
	KX	Cable adapter to MKS 15-Pin D (Unit "K"); adapts G1 base									
	SX	9 pin D with STEC pin-out (w/VTP) (Unit "S","Q")									
	UX	Cable adapter to 15 pin D (w/VTP) (Unit & TN "U"); adapts SX base									
		DeviceNet Standard Configuration Parameters									
		I/O	Connector	Power On State	Full Scale Setting	Full Scale Setting	Full Scale Setting	Poll IO Instance Producer	Poll IO Instance Consumer	Poll IO State Transition	External Baud Rate
	D0	DeviceNet	5 Pin Micro	Idle	Count	Integer	6000h	2	7	Executing	500KB
	D1	DeviceNet	5 Pin Micro	Idle	Count	Integer	6000h	21	7	Executing	500KB
	D2	DeviceNet	5 Pin Micro	Idle	SCCM	Float	7FFFh	13	19	Executing	500KB
	D3	DeviceNet	5 Pin Micro	Idle	Count	Integer	6000h	22	7	Executing	500KB
	D4	DeviceNet	5 Pin Micro	Executing	Count	Integer	6000h	22	8	Executing	500KB
	D5	DeviceNet	5 Pin Micro	Idle	Count	Integer	6000h	6	8	Executing	500KB
	D6	DeviceNet	5 Pin Micro	Idle	Count	Integer	7FFFh	3	7	Executing	500KB
	D7	DeviceNet	5 Pin Micro	Idle	Count	Integer	7FFFh	6	8	Executing	500KB
	D8	DeviceNet	5 Pin Micro	Idle	Count	Integer	6000h	3	7	Executing	500KB
	D9	DeviceNet	5 Pin Micro	Executing	Count	Integer	6000h	2	7	Executing	500KB
DA	DeviceNet	5 Pin Micro	Idle	Count	Integer	7FFFh	22	7	Executing	500KB	
DB	DeviceNet	5 Pin Micro	Idle	Count	Integer	6000h	22	8	Executing	500KB	
DC	DeviceNet	5 Pin Micro	Idle	Count	Integer	7FFFh	3	7	Idle	500KB	
DD	DeviceNet	5 Pin Micro	Executing	Count	Integer	7FFFh	22	8	Executing	500KB	
DE	DeviceNet	5 Pin Micro	Executing	SCCM	Float	6000h	15	19	Executing	500KB	
DX	DeviceNet	5 Pin Micro	To be defined by CSR								
XI. Customer Special Request	XXXX	Customer Special Request Number									
XII. Auto Shut-Off	A	Auto Shut-Off (Included)									
	X	Auto Shut-Off (Not Included) (Must be selected for meter)									
XIII. Auto Zero	A	Auto Zero (Included)									
	X	Auto Zero (Not Included)									
XIV. Reference Temperature	000	0°C Reference Calibration (Standard) - Default Setting									

Sample Standard Model Code

I	II	III	IV	V	VI	VII	VIII	IX	X	XI	XII	XIII	XIV
GF	101	C	XX	C	- SH52 100L	- V1	A	0	G1	- XXXX	A	X	- 000

Brooks Service and Support

Brooks is committed to assuring all of our customers receive the ideal flow solution for their application, along with outstanding service and support to back it up. We operate first class repair facilities located around the world to provide rapid response and support. Each location utilizes primary standard calibration equipment to ensure accuracy and reliability for repairs and recalibration and is certified by our local Weights and Measures Authorities and traceable to the relevant International Standards.

Visit www.BrooksInstrument.com to locate the service location nearest to you.

START-UP SERVICE AND IN-SITU CALIBRATION

Brooks Instrument can provide start-up service prior to operation when required. For some process applications, where ISO-9001 Quality Certification is important, it is mandatory to verify and/or (re)calibrate the products periodically. In many cases this service can be provided under in-situ conditions, and the results will be traceable to the relevant international quality standards.

CUSTOMER SEMINARS AND TRAINING

Brooks Instrument can provide customer seminars and dedicated training to engineers, end users, and maintenance persons.

Please contact your nearest sales representative for more details.

Due to Brooks Instrument's commitment to continuous improvement of our products, all specifications are subject to change without notice.

TRADEMARKS

Brooks, MultiFlo Brooks Instrument, LLC

All other trademarks are the property of their respective owners.



Global Headquarters

Brooks Instrument
407 West Vine Street
Hatfield, PA
19440-0903 USA

Toll-Free (USA): 888-554-FLOW
T: 215-362-3500
F: 215-362-3745

BrooksAM@BrooksInstrument.com

A list of all Brooks Instrument locations and contact details can be found at www.BrooksInstrument.com

©Copyright 2017 Brooks Instrument, LLC All rights reserved. Printed in U.S.A.

BROOKS[®]
INSTRUMENT